



CAPACITIVE SENSORS

Capacitive sensors detect the presence of any object into the sensible area. They have a higher sensitivity detecting metal objects or materials with a high content of water which have a high dielectric constant.

WORKING PRINCIPLE

An electrostatic field is generated in the sensible area. When an object gets in the sensing area changing its capacitive value, the oscillator stage starts oscillating, creating a commutation of the output stages. It's possible to adjust the sensing distance of capacitive sensors operating on the potentiometer placed on the back plastic cap or laterally in the connector versions. The factory regulation is the maximum value of the range declared on the catalogue.

CAPACITIVE SENSORS

- AKS** = amplified a.c.
- BKS** = amplified d.c.
- NKS** = NOT amplified d.c. NAMUR series

Diameter of cylindrical sensor.
For other types, change the number with the following:

- P** = rectangular plastic 5 positions head 40 x 40 x 112

- P** = plastic housing

- 4** = flush mounting
- 5** = non flush mounting

BKS	18	P/	4	6	0	9	KS	-5	PUR
------------	-----------	-----------	----------	----------	----------	----------	-----------	-----------	------------

- 3** = with connector M12 x 1
- 6** = standard type cable output
- *** = male connector cabled on sensor (see pag. H-1)

- 0** = NO (normally open output)
- 1** = NC (normally closed output)
- 2** = NO + NC (complementary outputs)
- C** = NC (normally closed output on pin 2 of connector)

- 0** = NAMUR series with 2 wires
- 8** = NPN
- 9** = PNP
- 9** = 20 ÷ 240 V. for a.c. sensors

- K** = protection against short circuit and overload
- S** = LED output status

Cable length (if required different than standard 2m)

For Polyurethane cable add PUR

NAMUR SERIES • Non-amplified in d.c. 2 wires • Cable output •

Housing C-1

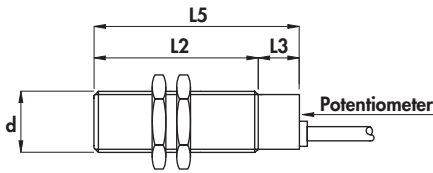

Housing G-2

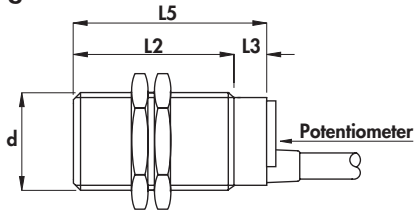

Typical curve

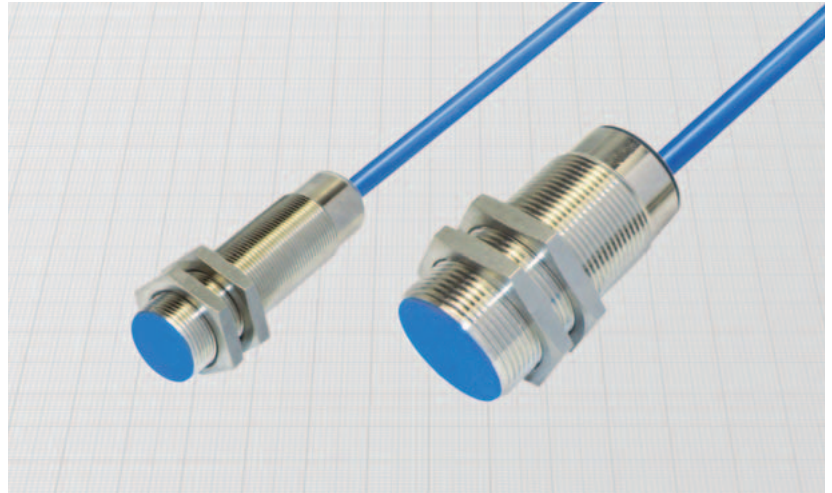
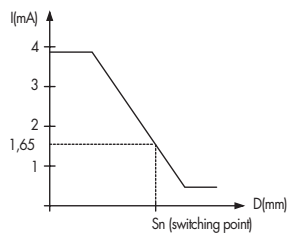

Diameter	M18 x 1	M30 x 1,5
Nut	Size	SW24
	Thickness mm	4
Max tightening torque Nm	35	80

Materials:

- Cable: 2 m PVC CEI 20 - 22 II; 90°C; 300 V; Ø.R.
- Housing: nickel plated brass
- Sensing face: plastic

General Features:

Capacitive sensors are suitable for any material detection. Some material, mostly if liquids, can be detected also through plastic or glass walls. They can be used for the most different applications: level controls on storage bin or tanks; detection of presence or filling of bottles; rain sensor; anti-vandalic key; etc. The adjustment of the sensing distance is possible through the potentiometer on the back cap.

Safety parameters:

- Working voltage: 7 ÷ 30 Vdc
- Supply voltage according to NAMUR: 7,7 ÷ 9 Vdc
- Max ripple: 10%
- Consumption at 8,2 V with Rx = 1000 Ω
 - with metal: ≥ 2,2 mA
 - without metal: ≤ 1 mA
- Temperature range: - 25° ÷ + 70°C
- Max thermal drift of sensing distance S_n: ± 20%
- Repeat accuracy (R): 4%
- Degree of protection: IP65
- Cable conductor cross section: 0,75 mm²
- According to EN60947-5-6
- Electromagnetic compatibility (EMC) according to EN60947-5-2
- Shock and vibration resistance according to EN60068-2-27 EN60068-2-6
- For certified ATEX version see ATEX Catalogue

Housing	Flush mounting Non flush mounting	L1	L2	L3	L4	L5	Cable diameter	Body diameter (d)	Max switching frequency (f)	Nominal sensing distance (S _n) ±10%	ORDERING REFERENCES
		mm	mm	mm	mm	mm					
C - 1	•	-	50	10	-	60	5	M18 x 1	100	2 ÷ 5	NKS18/4600
G - 2	•	-	50	10	-	60	5	M30 x 1,5	100	4 ÷ 10	NKS30/4600

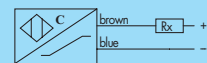

CYLINDRICAL CAPACITIVE SENSORS IN METAL HOUSING

- Amplified in d.c. 4 wires
- Cable output

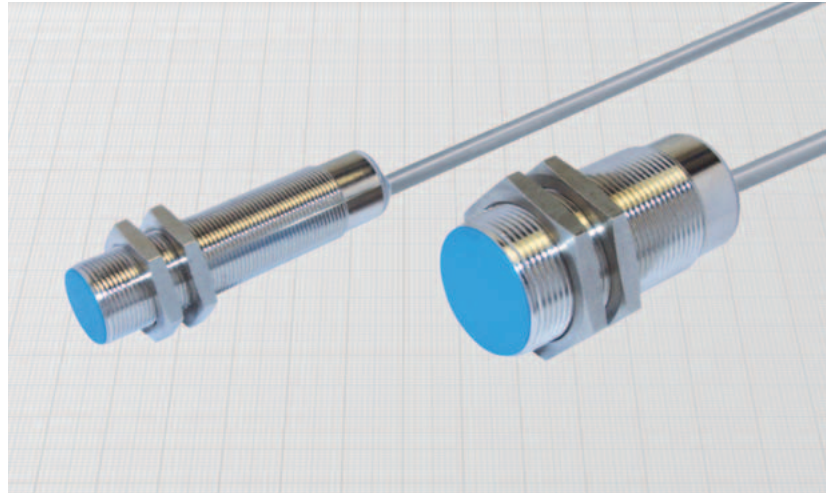
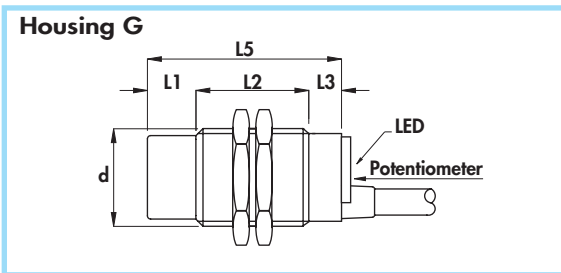
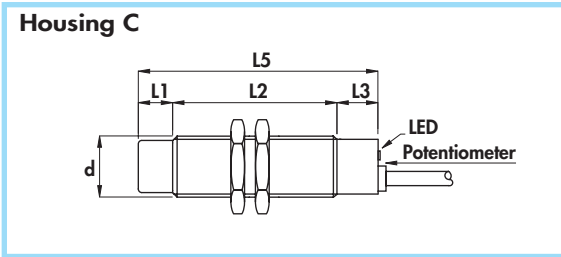

Diameter	M18 x 1	M30 x 1,5
Nut	Size	SW24
	Thickness mm	4
Max tightening torque Nm	35	80

Materials:

- Cable: 2 m PVC CEI 20 - 22 II; 90°C; 300 V; O.R.
- Housing: nickel plated brass
- Sensing face: plastic

General Features:

Capacitive sensors are suitable for any material detection. Some material, mostly if liquids, can be detected also through plastic or glass walls. They can be used for the most different applications: level controls on storage bin or tanks; detection of presence or filling of bottles; rain sensor; anti-vandalic key; etc. The adjustment of the sensing distance is possible through the potentiometer on the back cap close to the LED.

Technical data:

- Supply voltage (U_B): 10 ÷ 60 Vdc
- Max ripple: 10%
- No-load supply current (I_0): ≤ 10 mA
- Voltage drop (U_d): ≤ 2,2 V
- Temperature range: - 25° ÷ + 70°C
- Max thermal drift of sensing distance S_s : ± 20%
- Repeat accuracy (R): 4%
- Switching hysteresis max (H): 15%
- Degree of protection: IP65
- Switch status indicator: yellow LED
- Cable conductor cross section: 0,35 mm² on 18 mm
0,50 mm² on 30 mm

- Protected against short-circuit and overload
- Protected against any wrong connection
- Suppression of initial false impulse
- Electromagnetic compatibility (EMC) according to EN60947-5-2
- Shock and vibration resistance according to EN60068-2-27 EN60068-2-6

Housing	Mounting	L1	L2	L3	L4	L5	Cable diameter	Body diameter (d)	Max switching frequency (F)	Rated operational current (I _e)	Nominal sensing distance (S _n) ±10%	ORDERING REFERENCES	
												PNP (positive switching)	NPN (negative switching)
C	• Flush mounting	-	50	10	-	60	5	M18 x1	100	400	2 ÷ 5		BKS18/4629KS BKS18/5629KS
C	• Non flush mounting	10	40	10	-	60	5	M18 x1	100	400	3 ÷ 10		
G	• Flush mounting	-	50	10	-	60	6	M30 x1,5	100	400	3 ÷ 10		BKS30/4629KS BKS30/5629KS
G	• Non flush mounting	15	35	10	-	60	6	M30 x1,5	100	400	5 ÷ 20		

Use the above mentioned part number changing the last number 9 with 8 (ie. BKS18/4628KS)

Amplified in d.c. •
Connector output M12 x 1 •

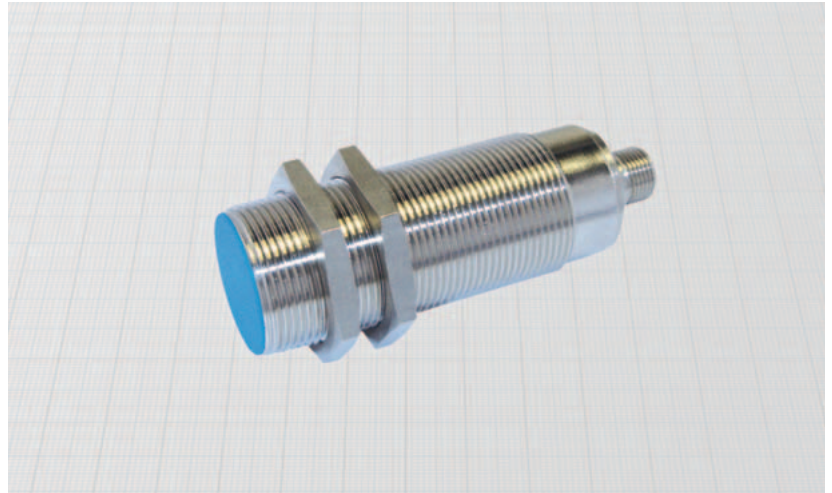
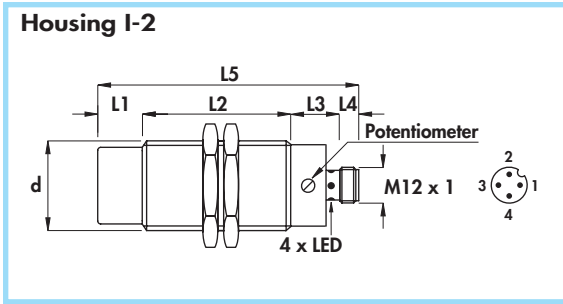

Diameter	M30 x 1,5	
Nut	Size	SW36
	Thickness mm	5
Max tightening torque Nm	80	

Materials:

- Housing: nickel plated brass
- Sensing face: plastic

General Features:

Capacitive sensors are suitable for any material detection. Some material, mostly if liquids, can be detected also through plastic or glass walls. They can be used for the most different applications: level controls on storage bin or tanks; detection of presence or filling of bottles; rain sensor; anti-vandalic key; etc. The adjustment of the sensing distance is possible through the potentiometer on the smooth part of the housing.

Technical data:

- Supply voltage (U_B): 10 ÷ 60 Vdc
- Max ripple: 10%
- No-load supply current (I_0): ≤ 10 mA
- Voltage drop (U_d): ≤ 2,2 V
- Temperature range: - 25° ÷ + 70°C
- Max thermal drift of sensing distance S_r : ± 20%
- Repeat accuracy (R): 4%
- Switching hysteresis max (H): 15%
- Degree of protection: IP65
- Switch status indicator: yellow LED
- Protected against short-circuit and overload
- Protected against any wrong connection
- Suppression of initial false impulse
- Electromagnetic compatibility (EMC) according to EN60947-5-2
- Shock and vibration resistance according to EN60068-2-27 EN60068-2-6

Housing	Mounting	L1	L2	L3	L4	L5	Female connector	Body diameter (d)	Max switching frequency (f)	Rated operational current (I _e)	Nominal sensing distance (S _n) ± 10%	ORDERING REFERENCES	
												PNP (positive switching)	
	Flush mounting Non flush mounting	mm	mm	mm	mm	mm	n°	mm	Hz	mA	mm	NO + NC 	
I-2	•	-	50	18	8	76	6-8B-10	M30 x 1,5	100	400	3 ÷ 10	BKS30S/4329KS	
I-2	•	15	35	18	8	76	6-8B-10	M30 x 1,5	100	400	5 ÷ 20	BKS30S/5329KS	
												NPN (negative switching) Use the above mentioned part number changing the last number 9 with 8 (ie. BKS30S/4328KS)	
												NO + NC 	

CYLINDRICAL CAPACITIVE SENSORS IN METAL HOUSING

- Amplified in a.c. 2 wires + earth
- Cable output

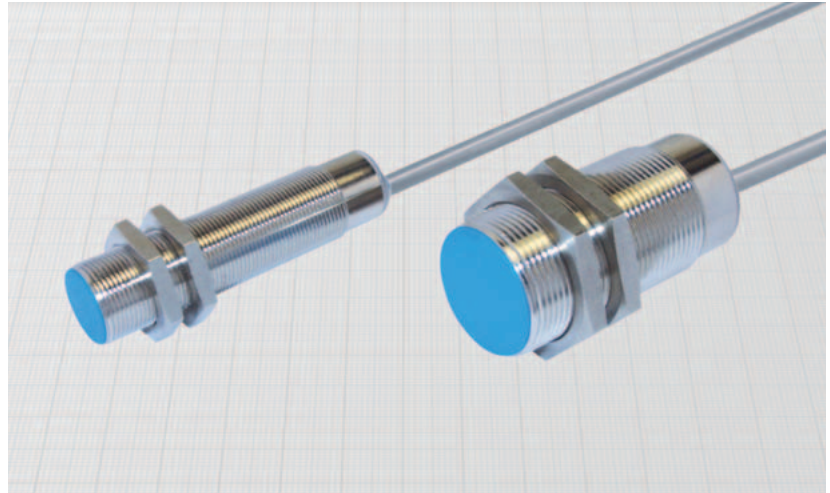
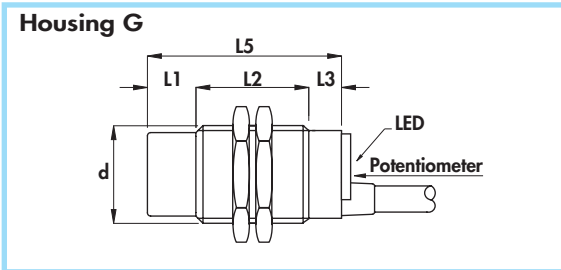
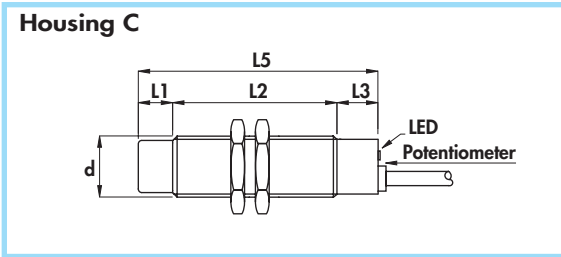

Diameter	M18 x 1	M30 x 1,5
Nut	Size	SW24
	Thickness mm	4
Max tightening torque Nm	35	80

Materials:

- Cable: 2 m PVC CEI 20 - 22 II; 90°C; 300 V; O.R.
- Housing: nickel plated brass
- Sensing face: plastic

General Features:

Capacitive sensors are suitable for any material detection. Some material, mostly if liquids, can be detected also through plastic or glass walls. They can be used for the most different applications: level controls on storage bin or tanks; detection of presence or filling of bottles; rain sensor; anti-vandalic key; etc. The adjustment of the sensing distance is possible through the potentiometer on the back cap close to the LED.

Technical data:

- Supply voltage (U_B): 20 ÷ 240 Vac
- Frequenza di rete: 40 ÷ 60 Hz
- Off-state current (I_o): ≤ 1,5 mA at 110 Vac
- Minimum operational current (I_m): 5 mA
- Voltage drop (U_d): ≤ 7 V
- Temperature range: - 25° ÷ + 70°C
- Max thermal drift of sensing distance S_s : ± 20%
- Repeat accuracy (R): 4%
- Switching hysteresis max (H): 15%
- Degree of protection: IP65
- Switch status indicator: yellow LED
- Cable conductor cross section: 0,35 mm² on 18 mm
0,75 mm² on 30 mm
- Suppression of initial false impulse
- Electromagnetic compatibility (EMC) according to EN60947-5-2
- Shock and vibration resistance according to EN60068-2-27 EN60068-2-6

Housing	Flush mounting Non flush mounting	L1	L2	L3	L4	L5	Cable diameter	Body diameter (d)	Max switching frequency (f)	Rated operational current (I _e)	Nominal sensing distance (S _n) ±10%	ORDERING REFERENCES	
		mm	mm	mm	mm	mm							
C	•	-	50	10	-	60	5	M18 x1	10	250	2 ÷ 5	AKS18/4609S AKS18/5609S	AKS18/4619S AKS18/5619S
C	•	10	40	10	-	60	5	M18 x1	10	250	3 ÷ 10		
G	•	-	50	10	-	60	6	M30 x1,5	10	250	3 ÷ 10	AKS30/4609S AKS30/5609S	AKS30/4619S AKS30/5619S
G	•	15	35	10	-	60	6	M30 x1,5	10	250	5 ÷ 20		

**NAMUR SERIES - diameters 18 - 30 mm •
Non-amplified in d.c. 2 wires •
Cable output •**

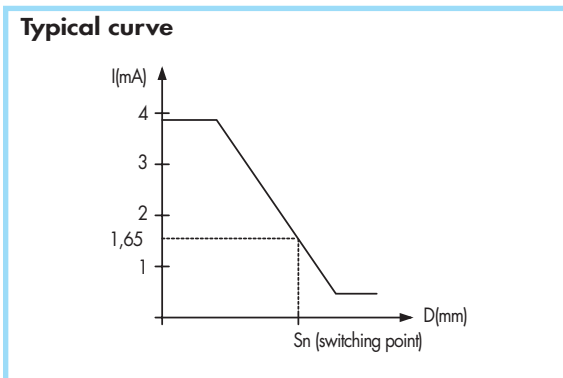
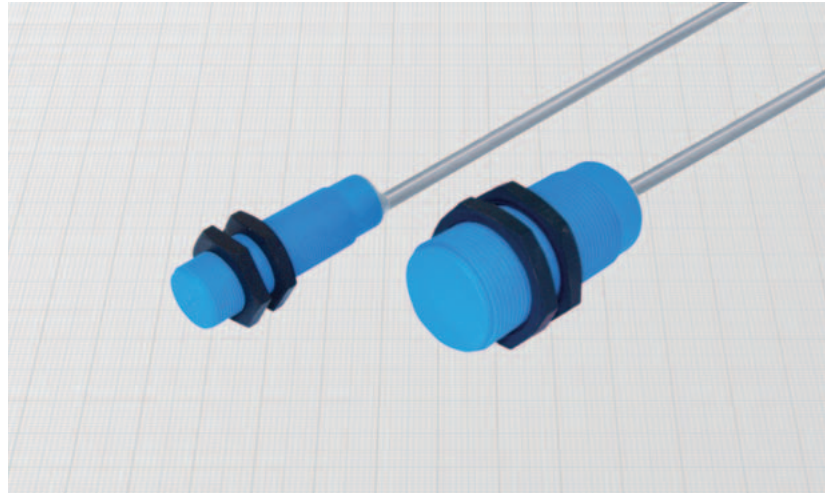
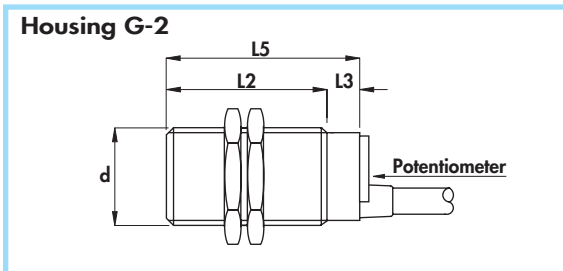
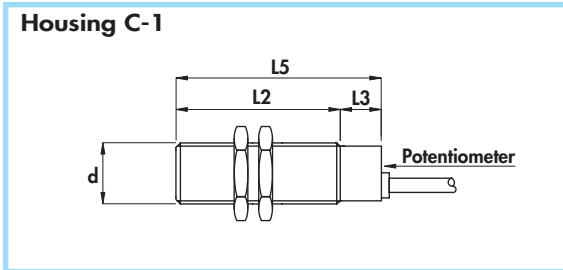

Diameter	M18 x 1	M30 x 1,5
Nut	Size	SW24
	Thickness mm	4
Max tightening torque Nm	5	20

Materials:

- Cable: 2 m PVC CEI 20 - 22 II; 90°C; 300 V; O.R.
- Housing: plastic
- Sensing face: plastic

General Features:

Capacitive sensors are suitable for any material detection. Some material, mostly if liquids, can be detected also through plastic or glass walls. They can be used for the most different applications: level controls on storage bin or tanks; detection of presence or filling of bottles; rain sensor; anti-vandalic key; etc.
The adjustment of the sensing distance is possible through the potentiometer on the back cap.

Safety parameters:

- Working voltage: $7 \div 30$ Vdc
- Supply voltage according to NAMUR: $7,7 \div 9$ Vdc
- Max ripple: 10%
- Consumption at 8,2 V with $R_x = 1000 \Omega$
 - with metal: $\geq 2,2$ mA
 - without metal: ≤ 1 mA
- Temperature range: $-25 \div +70$ °C
- Max thermal drift of sensing distance S_r : $\pm 20\%$
- Repeat accuracy (R): 4%
- Degree of protection: IP65
- Cable conductor cross section: $0,75$ mm²
- According to EN60947-5-6
- Electromagnetic compatibility (EMC) according to EN60947-5-2
- Shock and vibration resistance according to EN60068-2-27 EN60068-2-6
- For certified ATEX version see ATEX Catalogue

Housing	Flush mounting Non flush mounting	L1	L2	L3	L4	L5	Cable diameter	Body diameter (d)	Max switching frequency (f)	Nominal sensing distance (S _n) ±10%	ORDERING REFERENCES
		mm	mm	mm	mm	mm					
C - 1	•	-	50	10	-	60	5	M18 x 1	100	2 ÷ 5	NKS18P/4600
G - 2	•	-	50	10	-	60	5	M30 x 1,5	100	4 ÷ 10	NKS30P/4600

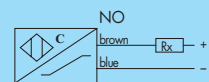

CYLINDRICAL CAPACITIVE SENSORS IN PLASTIC HOUSING

- Amplified in d.c. 4 wires
- Diameters 18 - 30 - 34 mm
- Cable output

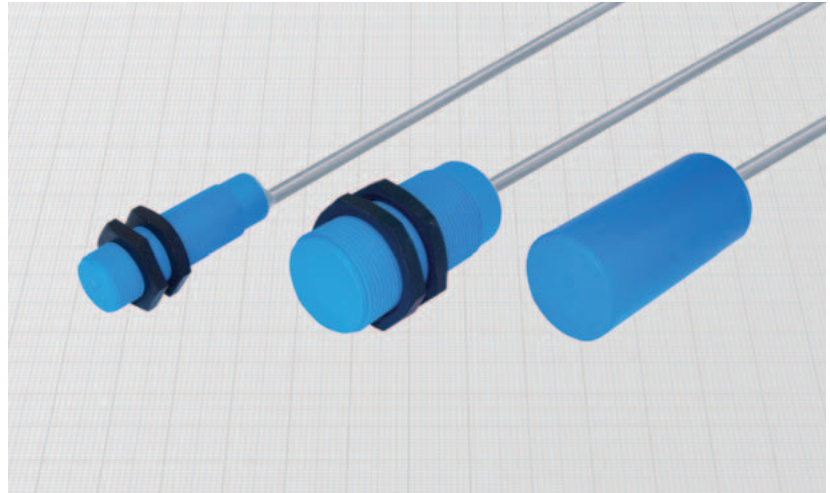
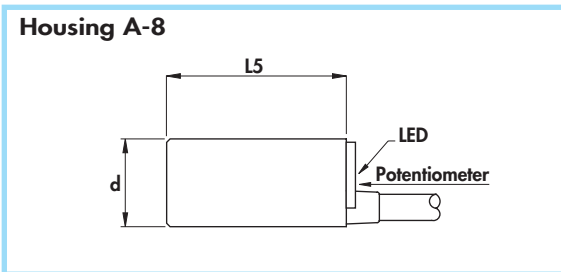
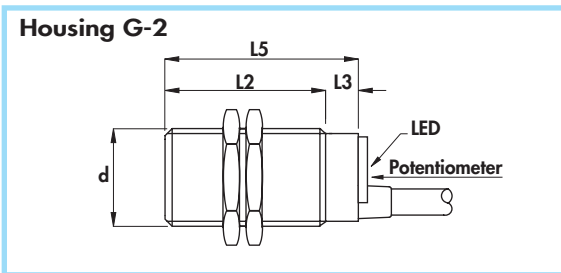
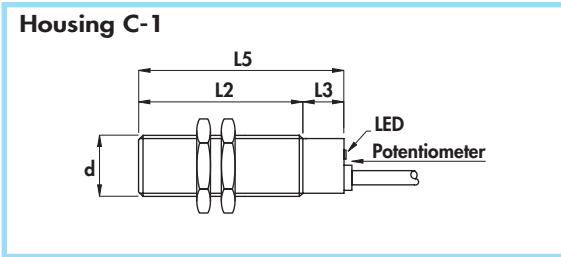

Diameter	M18 x 1	M30 x 1,5
Nut	Size	SW24
	Thickness mm	4
Max tightening torque Nm	5	20

Materials:

- Cable: 2 m PVC CEI 20 - 22 II; 90°C; 300 V; O.R.
- Housing: plastic
- Sensing face: plastic

General Features:

Capacitive sensors are suitable for any material detection. Some material, mostly if liquids, can be detected also through plastic or glass walls. They can be used for the most different applications: level controls on storage bin or tanks; detection of presence or filling of bottles; rain sensor; anti-vandalic key; etc. The adjustment of the sensing distance is possible through the potentiometer on the back cap close to the LED.

Technical data:

- Supply voltage (U_b): 10 ÷ 60 Vdc
- Max ripple: 10%
- No-load supply current (I_0): ≤ 10 mA
- Voltage drop (U_d): ≤ 2,2 V
- Temperature range: -25° ÷ +70°C
- Max thermal drift of sensing distance S_T : ± 20%
- Repeat accuracy (R): 4%
- Switching hysteresis max (H): 15%
- Degree of protection: IP65
- Switch status indicator: yellow LED
- Cable conductor cross section: 0,50 mm²
- Protected against short-circuit and overload
- Protected against any wrong connection
- Suppression of initial false impulse
- Electromagnetic compatibility (EMC) according to EN60947-5-2
- Shock and vibration resistance according to EN60068-2-27 EN60068-2-6

Housing	Flush mounting Non flush mounting	L1	L2	L3	L4	L5	Cable diameter	Body diameter (d)	Max switching frequency (F)	Rated operational current (I _e)	Nominal sensing distance (S _n) ± 10%	ORDERING REFERENCES	
		mm	mm	mm	mm	mm						mm	PNP (positive switching)
C-1	•	-	50	10	-	60	5	M18 x 1	100	400	2 ÷ 5		BKS18P/4629KS
C-1	•	-	40	10	-	60	5	M18 x 1	100	400	3 ÷ 10		BKS18P/5629KS
G-2	•	-	50	10	-	60	6	M30 x 1,5	100	400	3 ÷ 10		BKS30P/4629KS
G-2	•	-	35	10	-	60	6	M30 x 1,5	100	400	5 ÷ 20		BKS30P/5629KS
A-8	•	-	-	-	-	70	6	34	100	400	3 ÷ 20	BKS34P/5629KS	

NPN (negative switching)

Use the above mentioned part number changing the last number 9 with 8 (ie. BKS18P/4628KS)

Amplified in a.c. 2 wires •
 Diameters 18 - 30 mm •
 Cable output •

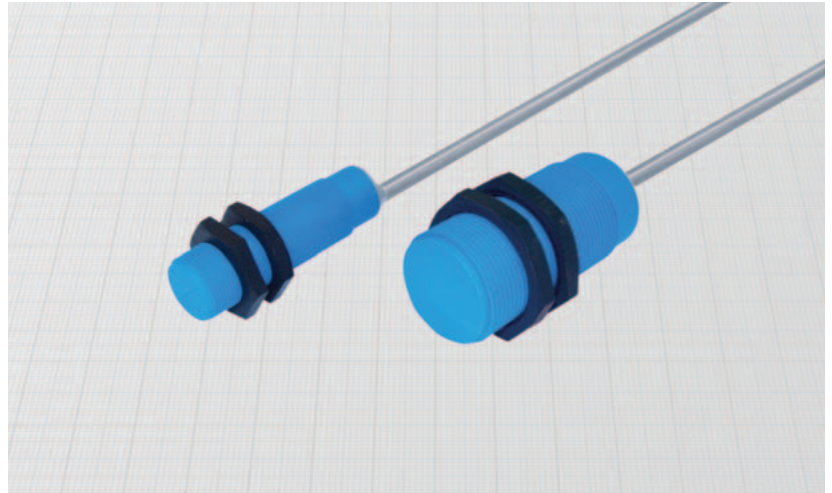
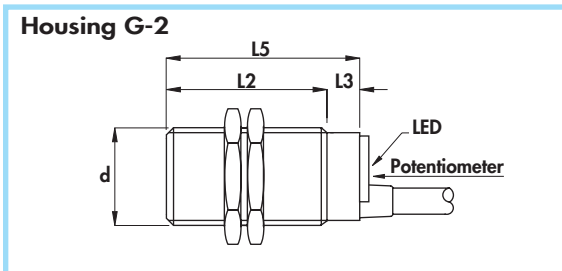
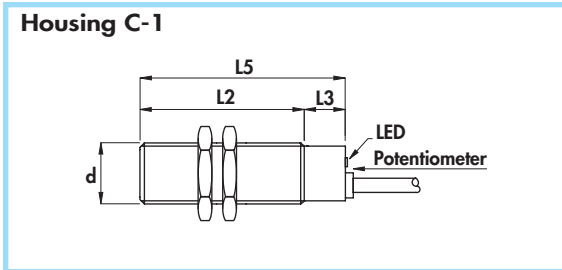

Diameter		M18 x 1	M30 x 1,5
Nut	Size	SW24	SW36
	Thickness mm	4	5
Max tightening torque Nm		5	20

Materials:

- Cable: 2 m PVC CEI 20 - 22 II; 90°C; 300 V; O.R.
- Housing: plastic
- Sensing face: plastic

General Features:

Capacitive sensors are suitable for any material detection. Some material, mostly if liquids, can be detected also through plastic or glass walls. They can be used for the most different applications: level controls on storage bin or tanks; detection of presence or filling of bottles; rain sensor; anti-vandalic key; etc.
 The adjustment of the sensing distance is possible through the potentiometer on the back cap close to the LED.

Technical data:

- Supply voltage (U_B): 20 ÷ 240 Vac
- Electrical system frequency: 40 ÷ 60 Hz
- Off-state current (I_o): ≤ 1,5 mA at 110 Vac
- Minimum operational current (I_m): 5 mA
- Voltage drop (U_d): ≤ 7 V
- Temperature range: - 25° ÷ + 70°C
- Max thermal drift of sensing distance S_r : ± 20%
- Repeat accuracy (R): 4%
- Switching hysteresis max (H): 15%
- Degree of protection: IP65
- Switch status indicator: yellow LED
- Cable conductor cross section: 0,50 mm² on 18 mm
0,75 mm² on 30 mm
- Suppression of initial false impulse
- Class 2 equipment according to IEC 536
- Shock and vibration according to EN60068-2-27 EN60068-2-6
- Electromagnetic compatibility (EMC) according to EN60947-5-2

Housing	Flush mounting Non flush mounting	L1	L2	L3	L4	L5	Cable diameter	Body diameter (d)	Max switching frequency (f)	Rated operational current (I _e)	Nominal sensing distance (S _n) ± 10%	ORDERING REFERENCES	
		mm	mm	mm	mm	mm							
C - 1	•	-	50	10	-	60	5	M18 x 1	10	250	2 ÷ 5	AKS18P/4609S	AKS18P/4619S
C - 1	•	-	50	10	-	60	5	M18 x 1	10	250	3 ÷ 10	AKS18P/5609S	AKS18P/5619S
G - 2	•	-	50	10	-	60	6	M30 x 1,5	10	250	3 ÷ 10	AKS30P/4609S	AKS30P/4619S
G - 2	•	-	50	10	-	60	6	M30 x 1,5	10	250	5 ÷ 20	AKS30P/5609S	AKS30P/5619S

RECTANGULAR CAPACITIVE SENSORS

- 5 Position head
- Amplified in d.c.
- Terminal block output

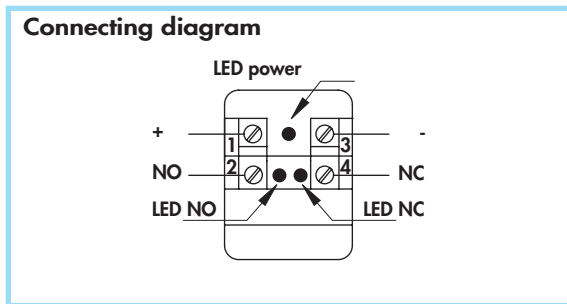
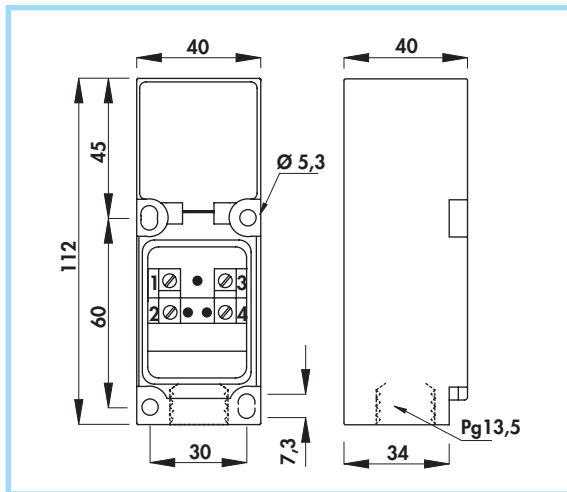

Materials:

- Housing: plastic
- Terminal block cover: polycarbonate

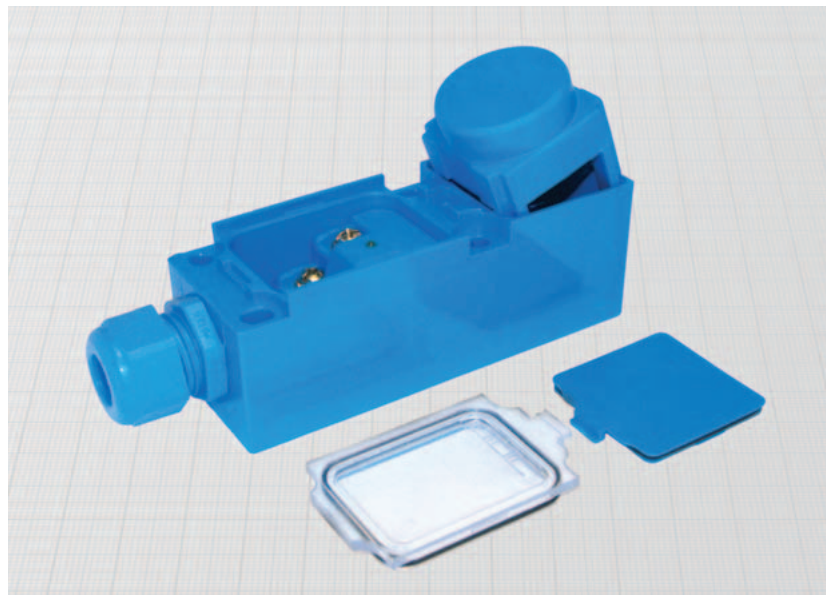

General Features:

These sensors are called "turnable sensing head" because the sensing head, inside the plastic housing can be positioned on 5 different positions. To choose the desired sensing face it is enough to remove the cover and set the sensing head in the proper position.

The internal terminal block can be easily reached by removing the transparent cover. Being capacitive, they are suitable for any material detection. Some material, mostly if liquids, can be detected also through plastic or glass walls. They can be used for the most different applications :

Level controls on storage bins or tanks; detection of presence or filling of bottles; rain sensor ; anti-vandalic key; etc...

The included plastic gland Pg13.5 is suited for cables diameter up to 9 mm.

Technical data:

- Supply voltage (U_B): 10 ÷ 60 Vdc
- Max ripple: 10%
- No-load supply current (I_0): ≤ 10 mA
- Voltage drop (U_d): ≤ 2,2 V
- Temperature range: -20° ÷ +70°C
- Max thermal drift of sensing distance S_p : ± 20%
- Repeat accuracy (R): 4%
- Switching hysteresis max (H): 15%
- Degree of protection with fully locked gland: IP65
- Status indicator: output n.o. yellow LED
output n.c. red LED
supply green LED

- Protected against short-circuit and overload
- Protected against any wrong connection
- Suppression of initial false impulse
- Electromagnetic compatibility (EMC) according to EN60947-5-2
- Shock and vibration resistance according to EN60068-2-27 EN60068-2-6

Flush mounting Non Flush mounting	Diameter zone sensible	Max switching frequency (f)	Rated operational current (I_e)	Nominal sensing distance (S_n) ± 10%	ORDERING REFERENCES
	mm	KHz	mA	mm	PNP (positive switching)
•	35	0,1	400	15	 BKSP/4729KS
					NPN (negative switching) Use the above mentioned part number changing the last number 9 with 8 (ie. BKSP/4728KS)