

OFA SERIES INSTRUCTION MANUAL

INSTALLATION

Don't bend the fibre-optics below, the specified minimum bending radius (R). Use the adapter supplied in the package to connect thin fibre-optics $\varnothing 1$ mm.

Use the AF11 cutting tool to cut the fibres to the desired length.

Cutting fibres may reduce the operating range.

Always use cutting tools with the blade in perfect conditions.

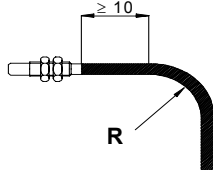

OFA-1-AE-20	M3 screws 0.6 Nm maximum tightening torque
OFA-1-AS-20	M3 screws 0.6 Nm maximum tightening torque
OFA-2-AE-20	M3 screws 0.6 Nm maximum tightening torque
OFA-2-AS-20	M3 screws 0.6 Nm maximum tightening torque
OFA-4-FE-20	M3 flat head screws 0.6 Nm maximum tightening torque
OFA-4-FF-20	M3 flat head screws 0.6 Nm maximum tightening torque
OFA-4-FS-20	M3 flat head screws 0.6 Nm maximum tightening torque
OFA-6-RA-20	M3 screws 0.6 Nm maximum tightening torque

Fibre optics	Sheath
PMMA	PE



Never apply excessive mechanical stresses to the fibres.

Never use organic solvents.

DIMENSIONS (mm)

OFA-1-AE-20

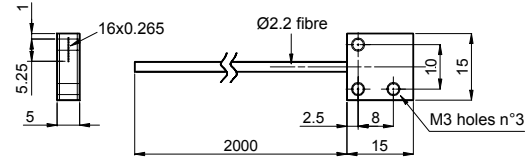

OFA-1-AS-20

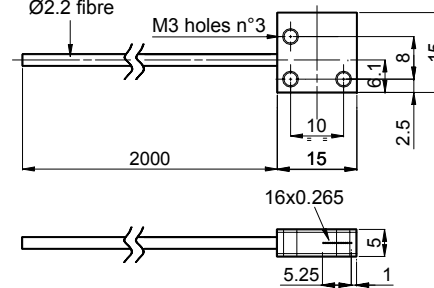

OFA-4-FS-20

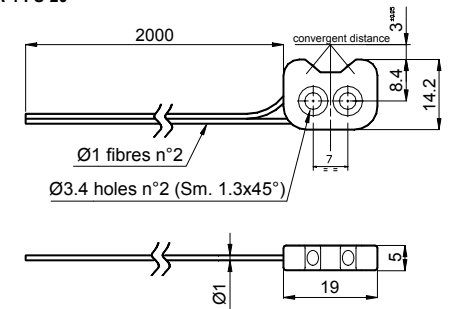

OFA-2-AE-20

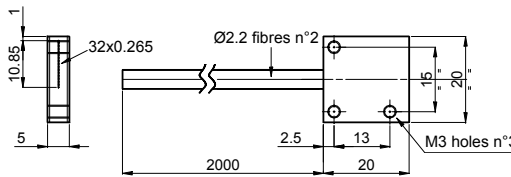

OFA-2-AS-20

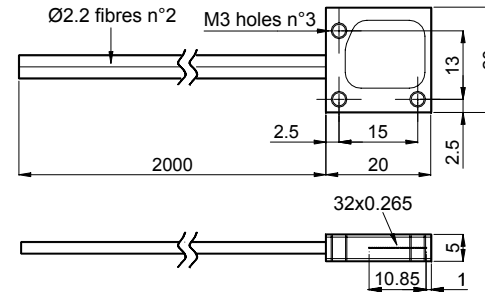

OFA-4-FF-20

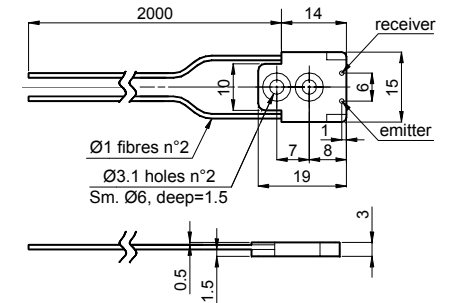

OFA-6-RA-20

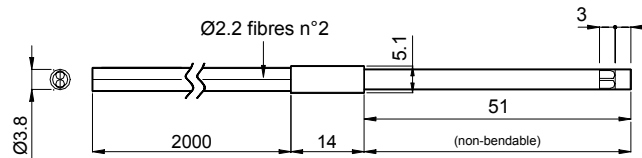

OFA-4-FE-20

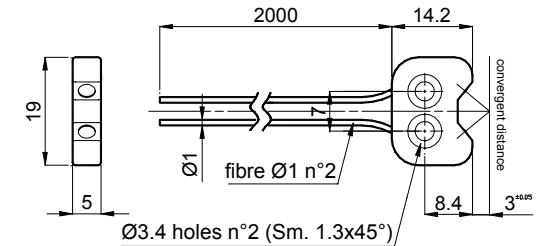

TECHNICAL DATA

Model	Function	Length (m)	Ø Sheath (mm)	Ø Fibres (mm)	Temp. (°C)	R (> mm)
OFA-1-AE-20	E/R	2	2.2	16 x 0.265	-30...+60	25
OFA-1-AS-20	E/R	2	2.2	16 x 0.265	-30...+60	25
OFA-2-AE-20	Proximity	2	2.2	32 x 0.265	-30...+60	25
OFA-2-AS-20	Proximity	2	2.2	32 x 0.265	-30...+60	25
OFA-4-FE-20	Fix foc proxi	2	1	0.5	-30...+60	10
OFA-4-FF-20	Fix foc.proxi	2	1	0.5	-30...+60	10
OFA-4-FS-20	Fix foc.proxi	2	1	0.5	-30...+60	10
OFA-6-RA-20	Proximity	2	2.2	1.5	-30...+60	25

ACCESSORY

AF11 (Cutting tool for $\varnothing 2.2$ mm and $\varnothing 1$ mm fibres)

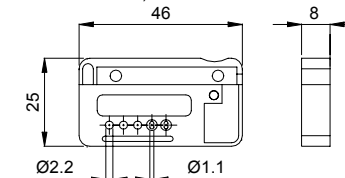

WARRANTY

DATASENSOR S.p.A. warrants its products to be free from defects. DATASENSOR S.p.A. will repair or replace, free of charge, any product found to be defective during the warranty period of 36 months from the manufacturing date. This warranty does not cover damage or liability deriving from the improper application of DATASENSOR products.

DATASENSOR S.p.A. Via Lavino 265
40050 Monte S. Pietro - Bologna - Italy
Tel: +39 051 6765811 Fax: +39 051 6759324
http://www.datasensor.com e-mail: info@datasensor.com



DATASENSOR S.p.A. cares for the environment: 100% recycled paper.

DATASENSOR S.p.A. reserves the right to make modifications and improvements without prior notification.

