



## S65-PA-5-V09 Colour sensor

### INSTRUCTION MANUAL

#### CONTROLS

##### OUTPUT LED

The yellow LED ON indicates the OR function of the three OUT1, OUT2 and OUT3 outputs.

##### DISPLAY (green 4-digit display)

The display indicates the "run" or "rund" (run with delay) operating mode. Please refer to the "SETTING" paragraph for the correct setup procedure indications.

##### OUT1, OUT2, OUT 3 LEDs

The green LED ON indicates that the corresponding output is active.

##### SET PUSHBUTTON

The pressure on the pushbutton activates the self-setting procedure.

A long pressure on the pushbutton allows the access to the delay setting menu.

##### SEL PUSHBUTTON

The pressure allows to scroll through the sensor setting parameter menu.

Please refer to the "SETTING" paragraph for the correct setup procedure indications.

#### INSTALLATION

The sensor can be mounted by means of the three housing's holes using two screws (M4x25 or longer, 1 Nm maximum tightening torque) with washers. The use of fixing brackets is recommended if the supporting surface doesn't have a good planarity. Various orientable fixing brackets to ease the sensor positioning are available (please refer to the accessories listed in the catalogue).

The operating distance is measured from the front surface of the sensor optics.

The M12 connector can be oriented at two different positions using the specific fastening spring and rotating the block of 180°.



#### CONNECTIONS

##### M12 CONNECTOR

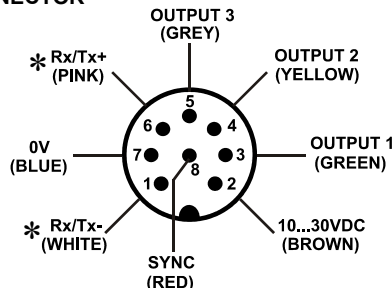

\* Available only for version with RS485 serial connection (S65-PA-5-V09-xxxZ).

#### TECHNICAL DATA

Power supply:	10 ... 30 Vdc limit values
Ripple:	2 Vpp max.
Consumption (output current excluded):	60 mA max. @ 24Vdc
Outputs:	3 PNP or NPN outputs 30 Vdc max. (short-circuit protection)
Tolerance level:	10 (toL0 - toL9) independent per each channel
Operating mode:	C, C+I independent per each channel
Output current:	100 mA max.
Output saturation voltage:	≤ 2 V
Response time:	335us
Switching frequency:	1.5 KHz
Indicators:	4-digit display (GREEN), OUTPUT LED (YELLOW) 3 OUTPUT STATUS LEDs (GREEN)
Setting:	SET pushbutton, SEL pushbutton
Data retention:	EEPROM non volatile memory
Operating temperature:	-10 ... 55 °C
Storage temperature:	-20 ... 70 °C
Electrical protection:	Class 2
Operating distance (typical values):	20 mm
Minimum spot dimension:	∅ 4 mm
Emission type:	white light LED (400-700nm)
Ambient light rejection:	according to EN 60947-5-2
Vibrations:	0.5 mm amplitude, 10 ... 55 Hz frequency, for every axis (EN60068-2-6)
Shock resistance:	11 ms (30 G) 6 shock for every axis (EN60068-2-27)
Housing material:	ABS
Lens material:	window and lenses in glass
Mechanical protection:	IP67
Connections:	M12 8-pole connector
Weight:	100 g. max.

#### DIMENSIONS

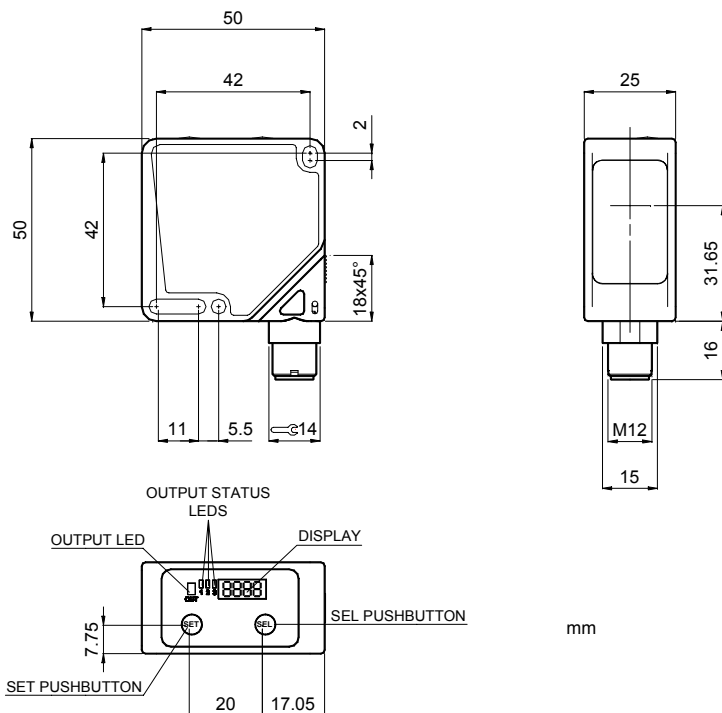

#### SETTING

The three-phase sensor setting allows the adjustment of the channel, operating mode and tolerance values.

- pushbutton pressed
- pushbutton not pressed

##### Detection

Place object to detect inside the operating distance, in front of the sensor.

OR	1	2	3	Dig1	Dig2	Dig3	Dig4	SET	SEL
■	□	□	■	r	u	n	d	●	○

- Press the SET pushbutton for at least 2s.

- The "Set1" message is visualised.

##### Channel setting

OR	1	2	3	Dig1	Dig2	Dig3	Dig4	SET	SEL
□	□	□	□	S	E	t	1	○	●

- Use the SEL pushbutton to select the channel to detection.

OR	1	2	3	Dig1	Dig2	Dig3	Dig4	SET	SEL
□	□	□	□	S	E	t	1	○	●



##### Operating mode

- Press the SET pushbutton again to configure the operating mode.

- Select C (colour) or C+I (colour + intensity) using the SEL pushbutton\*.

OR	1	2	3	Dig1	Dig2	Dig3	Dig4	SET	SEL
□	□	□	□	C				●	○

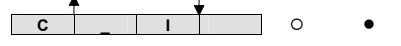

##### TEACH and tolerance setting

- Press the SET pushbutton again, the "updt" text blinks for 2s.

The sensor then automatically passes into the tolerance selection.

Use the SEL pushbutton to select the required value.

OR	1	2	3	Dig1	Dig2	Dig3	Dig4	SET	SEL
□	□	□	□	u	p	d	t	●	○

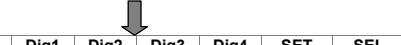

OR	1	2	3	Dig1	Dig2	Dig3	Dig4	SET	SEL
□	□	□	□	t	o	L	0	○	●

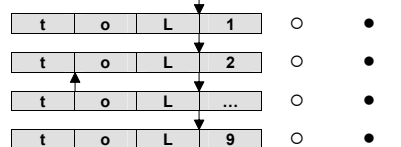

- The "FAIL" text alternated with "Hi" or "Lo" is visualised if the detection is not correct.

- Repeat the procedure starting from the operating mode.

**NOTE:** The 0, 1, 2 tolerance values are particularly suitable for critical applications.

#### PARAMETER SETTING

##### Delay value visualisation and setting

OR	1	2	3	Dig1	Dig2	Dig3	Dig4	SET	SEL
■	□	□	■	r	u	n	d	●	○

Press the SET pushbutton for at least 6s to access to the delay setting mode.

OR	1	2	3	Dig1	Dig2	Dig3	Dig4	SET	SEL
□	□	□	□	d	-	0	0	○	●

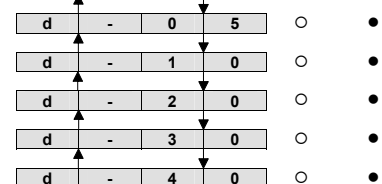

At each pressure of the SEL pushbutton, the different delay levels in ms are visualised in a cyclical manner at the output deactivation and moreover, the relative delay value will be stored. When the "d-00" message is visualised the operating mode will be "run", and "rund" in all other cases.

The delay value setting is in common for all three outputs.

When a delay value, different from zero, is set the outputs will be maintained active for a minimum time, which is equal to the number of milliseconds visualised on the display.

- d-00 = 0 ms
- d-05 = 5 ms
- d-10 = 10 ms
- d-20 = 20 ms
- d-30 = 30 ms
- d-40 = 40 ms

##### Channel status visualisation

This function allows a rapid control of the three sensor channel adjustment.

Pressing the SEL pushbutton for at least 2 s the channel, operating mode and tolerance are visualised in a sequential manner.

OR	1	2	3	Dig1	Dig2	Dig3	Dig4	SET	SEL
■	□	□	■	r	u	n	d	●	○

OR	1	2	3	Dig1	Dig2	Dig3	Dig4	SET	SEL
■	□	□	□	C	h		1	○	●

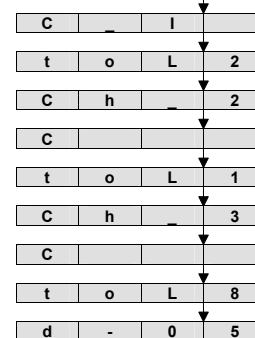

At the end of the sequence the display will indicate the "run" or "rund" operating mode again.

##### Non-initialised E2PROM

If the display indicates "E2Pr" the sensor does not have any of the three channels initialised.

OR	1	2	3	Dig1	Dig2	Dig3	Dig4	SET	SEL
□	□	□	□	E	2	P	r	○	○

In this case it is sufficient to program one single channel to obtain the "run" or "rund" visualisation on the display.

\* The 'C' type algorithm is used to obtain a larger depth of field, or to detect colours on different opaque, shiny or reflecting surfaces. Whereas the 'C+I' type algorithm offers a higher sensitivity towards tone variations and is recommended for the detection of different colours on the same type of material, with the possibility of distinguishing also the grey tones.

#### REMOTE FUNCTIONS

##### KEYLOCK function (SET pushbutton block)

If at sensor powering the SYNC wire is connected to +Vdc for at least 1s, the keylock function is activated and the pushbuttons are no longer active.

After the first second, the SYNC input is available for the normal operating modes; if SYNC is high the outputs are deactivated.

To deactivate the keylock, the sensor has to be turned off and re-powered with the SYNC wire not connected or ground connected (GND).

##### SYNC input

The SYNC signal can exactly determine the beginning and end of the colour identification.

The identification cycle begins after the SYNC signal changes from passive to active and the sensor outputs have to be updated after max. 335µs.

All the outputs are deactivated after max. 170µs from an active passage to a passive one.

The connection of the SYNC wire to Vdc corresponds to the passive logic status while SYNC not connected or connected to 0V corresponds to the active logic status.

(SYNC passive = Vdc ; SYNC active = 0V)

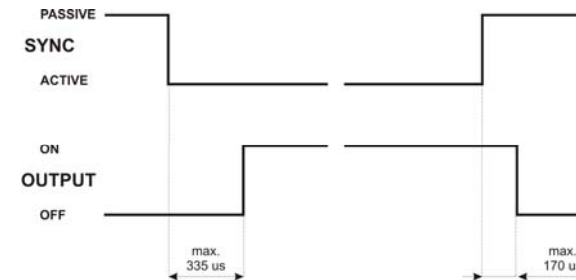

A typical application is a multicoloured target where the colour to detect is in a determinate position, while the other zones have to be faded out. Moreover, incorrect detections can be avoided during transition from the target to the background.

##### RS485 serial connection only for version S65-PA-5-V09-xxxZ

The complete sensor remote control is possible using the RS485 line.

All the functions such as the channel selection, the tolerance selection and the operating mode can be accessed by means of this serial line.

The serial communication parameters are: 9600 baud, no parity, 8 data bits, 1 stop bit.

All the commands have to be sent via terminal in an ASCII format as follows:

##### Receiving of the channel status:

At any moment, the receipt of the 'r <CR> <LF>' command indicates the sensor configuration.

##### Remote setting mode:

To access to the remote setting mode, the SYNC input has to remain passive for at least 300ms.

The commands available are given below:

- @ <CR> <LF> beginning of the remote setting (together with passive SYNC)
- cx <CR> <LF> channel selection, with x ∈ {1,2,3}
- tx <CR> <LF> tolerance selection, with x ∈ {0,1,2,3,4,5,6,7,8,9}
- mx <CR> <LF> operating mode selection, with x ∈ {1,2}

m1 = C

m2 = C+I

e <CR> <LF> configuration sequence activation.

q <CR> <LF> exit from the remote setting mode without saving configuration.

If the SYNC input is activated before the 'e' (execute) command is given, the sensor exits the remote setting mode without saving the configuration, similarly to the receipt of the 'q' (quit) command.

If the SYNC input is active, at the receipt of the @ <CR> <LF> command, the sensor responds with: ?? <CR> <LF>. At the receipt of the q <CR> <LF> or e <CR> <LF> commands, the sensor transmits ok <CR> <LF>.

The lo <CR> <LF> message is transmitted if the signal is too low and hi <CR> <LF> if the signal is too high.

##### Delay configuration:

To access to the delay configuration, the SYNC input has to remain passive for at least 300 ms. The commands available are given below:

- @ <CR> <LF> beginning of the delay configuration (together with passive SYNC)
- dx <CR> <LF> delay selection, with x ∈ {0,1,2,3,4,5}

d0 = 0 ms

d1 = 5 ms

d2 = 10 ms

d3 = 20 ms

d4 = 30 ms

d5 = 40 ms

e <CR> <LF> memorisation of the new delay value

q <CR> <LF> exit from the delay configuration without saving the configuration.

If the SYNC input is activated before the 'e' (execute) command is given, the sensor exits the remote setting mode without saving the configuration, similarly to the receipt of the 'q' (quit) command.

If the SYNC input is active, at the receipt of the @ <CR> <LF> command, the sensor responds with: ?? <CR> <LF>. At the receipt of the q <CR> <LF> or e <CR> <LF> commands, the sensor transmits ok <CR> <LF>.

##### DECLARATION OF CONFORMITY

We DATASENSOR S.p.A. declare under our sole responsibility that these products are conform to the 89/336 CEE, 73/23 CEE Directives and successive amendments.

##### WARRANTY

DATASENSOR S.p.A. warrants its products to be free from defects.

DATASENSOR S.p.A. will repair or replace, free of charge, any product found to be defective during the warranty period of 36 months from the manufacturing date.

This warranty does not cover damage or liability deriving from the improper application of DATASENSOR products.

DATASENSOR S.p.A. Via Lavino 265  
40050 Monte S. Pietro - Bologna - Italy  
Tel: +39 051 6765611 Fax: +39 051 6759324  
http://www.datasensor.com e-mail: info@datasensor.com

DATASENSOR S.p.A. cares for the environment: 100% recycled paper. DATASENSOR S.p.A. reserves the right to make modifications and improvements without prior notification.



**S65-PA-5-V19**  
Colour sensor

## INSTRUCTION MANUAL

### CONTROLS

#### OUTPUT LED

The yellow LED ON indicates the OR function of the three OUT1, OUT2 and OUT3 outputs.

#### DISPLAY (green 4-digit display)

The display indicates the "run" or "rund" (run with delay) operating mode. If the FAST commutating speed is selected, the display visualizes every 40 sec (for 5 sec) the notice "FAST". Please refer to the "SETTING" paragraph for the correct setup procedure indications.

#### OUT1, OUT2, OUT 3 LEDs

The green LED ON indicates that the corresponding output is active.

#### SET PUSHBUTTON

The pressure on the pushbutton activates the self-setting procedure. A long pressure on the pushbutton allows the access to the delay setting menu.

#### SEL PUSHBUTTON

The pressure allows to scroll through the sensor setting parameter menu. Please refer to the "SETTING" paragraph for the correct setup procedure indications.

### INSTALLATION

The sensor can be positioned by means of the three housing's holes using screws (M4x35 or longer, 1 Nm maximum tightening torque) with washers. The use of fixing brackets is recommended if the supporting surface doesn't have a good planarity.

Various orientable fixing brackets to ease the sensor positioning are available (please refer to the accessories listed in the catalogue). The operating distance is measured from the front surface of the sensor optics.

The M12 connector can be oriented at three different positions using the specific fastening spring and rotating the block of 90°.



### CONNECTIONS

#### M12 CONNECTOR

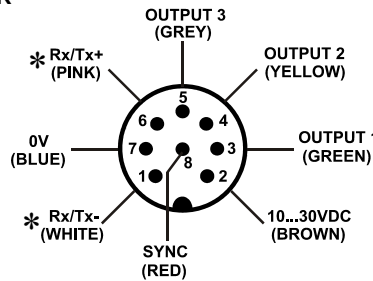

\* Available only for version with RS485 serial connection (S65-PA-5-V19-xxxZ).

### TECHNICAL DATA

Power supply:	10 ... 30 Vdc limit values
Ripple:	2 Vpp max.
Consumption (output current excluded):	60 mA max. @ 24Vdc
Outputs:	3 PNP or NPN outputs 30 Vdc max. (short-circuit protection)
Tolerance level:	10 (toL0 - toL9) independent per each channel
Operating mode:	C, C+ independent per each channel
Output current:	100 mA max.
Output saturation voltage:	≤ 2 V
Response time:	5ms (NORM) ; 1ms (FAST)
Switching frequency:	100 Hz (NORM) ; 500 Hz (FAST)
Indicators:	4-digit display (GREEN), OUTPUT LED (YELLOW) 3 OUTPUT STATUS LEDs (GREEN)
Setting:	SET pushbutton, SEL pushbutton
Data retention:	EEPROM non volatile memory
Operating temperature:	-10 ... 55 °C
Storage temperature:	-20 ... 70 °C
Electrical protection:	Class 2
Operating distance (typical values):	20 mm
Minimum spot dimension:	∅ 4 mm
Emission type:	white light LED (400-700nm)
Ambient light rejection:	according to EN 60947-5-2
Vibrations:	0.5 mm amplitude, 10 ... 55 Hz frequency, for every axis (EN60068-2-6)
Shock resistance:	11 ms (30 G) 6 shock for every axis (EN60068-2-27)
Housing material:	ABS
Lens material:	window and lenses in glass
Mechanical protection:	IP67
Connections:	M12 8-pole connector
Weight:	100 g. max.

### DIMENSIONS

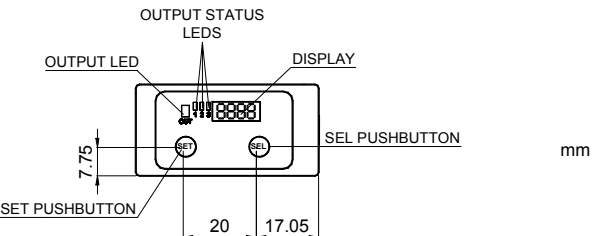
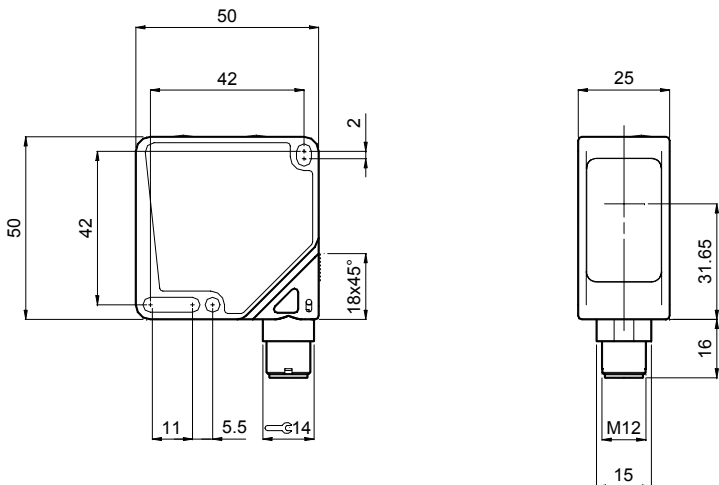

### SETTING

The three-phase sensor setting allows the adjustment of the channel, operating mode and tolerance values.

- pushbutton pressed ○ pushbutton not pressed

- **Detection**  
Place object to detect inside the operating distance, in front of the sensor spot.

OUT	1	2	3	Dig1	Dig2	Dig3	Dig4	SET	SEL
■	□	□	■	r	u	n	d	●	○

- Press the SET pushbutton for at least 2s.
- The "Set1" message is visualised.

- **Channel setting**

OUT	1	2	3	Dig1	Dig2	Dig3	Dig4	SET	SEL
□	□	□	□	S	E	t	1	○	●

- Use the SEL pushbutton to select the channel.

OUT	1	2	3	Dig1	Dig2	Dig3	Dig4	SET	SEL
□	□	□	□	S	E	t	2	○	●

- Operating mode

- Press the SET pushbutton again to configure the operating mode.
- Select C (colour) or C+ (colour + intensity) using the SEL pushbutton\*.

OUT	1	2	3	Dig1	Dig2	Dig3	Dig4	SET	SEL
□	□	□	□	C	h	i	1	○	●

- The 'C' type algorithm is used to obtain a larger depth of field, or to detect colours on different opaque, shiny or reflecting surfaces. Whereas the 'C+' type algorithm offers a higher sensitivity towards tone variations and is recommended for the detection of different colours on the same type of surface, with the possibility of distinguishing also the grey tones.

- **TEACH and tolerance setting**

- Press the SET pushbutton again, the "uptd" text blinks for 2s. The sensor then automatically passes into the tolerance selection. Use the SEL pushbutton to select the required value.

OUT	1	2	3	Dig1	Dig2	Dig3	Dig4	SET	SEL
□	□	□	□	u	p	t	d	●	○

OUT	1	2	3	Dig1	Dig2	Dig3	Dig4	SET	SEL
□	□	□	□	t	o	L	0	○	●

OUT	1	2	3	Dig1	Dig2	Dig3	Dig4	SET	SEL
□	□	□	□	t	o	L	1	○	●

OUT	1	2	3	Dig1	Dig2	Dig3	Dig4	SET	SEL
□	□	□	□	t	o	L	2	○	●

OUT	1	2	3	Dig1	Dig2	Dig3	Dig4	SET	SEL
□	□	□	□	t	o	L	...	○	●

OUT	1	2	3	Dig1	Dig2	Dig3	Dig4	SET	SEL
□	□	□	□	t	o	L	9	○	●

- The "FAIL" text alternated with "Hi" or "Lo" is visualised if the detection is not correct.
- Repeat the procedure starting from the operating mode.

- The tolerance level increases from "toL0" to "toL9". To detect small chromatic differences select lower tolerance levels.

### PARAMETER SETTING

#### Delay value visualisation and setting

OUT	1	2	3	Dig1	Dig2	Dig3	Dig4	SET	SEL
■	□	□	■	r	u	n	d	●	○

Press the SET pushbutton for at least 6s to access to the delay setting mode.

OUT	1	2	3	Dig1	Dig2	Dig3	Dig4	SET	SEL
□	□	□	□	d	-	0	0	○	●

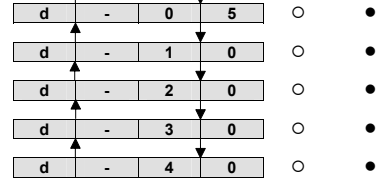

At each pressure of the SEL pushbutton, the different delay levels in ms are visualised in a cyclical manner at the output deactivation and moreover, the relative delay value will be stored. When the "d-00" message is visualised the operating mode will be "run", and "rund" in all other cases.

The delay value setting is in common for all three outputs. When a delay value, different from zero, is set the outputs will be maintained active for a minimum time, which is equal to the number of milliseconds visualised on the display.

d-00 = 0 ms	d-20 = 20 ms
d-05 = 5 ms	d-30 = 30 ms
d-10 = 10 ms	d-40 = 40 ms

#### Visualization and set up of the FAST commutating speed

OUT	1	2	3	Dig1	Dig2	Dig3	Dig4	SET	SEL
■	□	□	■	r	u	n	d	●	○

By pressing of SET and SEL buttons at the same time for 2 seconds at least, you enter in the set up mode of the commutating speed.

OUT	1	2	3	Dig1	Dig2	Dig3	Dig4	SET	SEL
□	□	□	□	n	o	r	n	○	●



At each pressure of the SEL push-button, the different commutating speed are displayed in cyclical mode and the correspondent speed value is saved. When message "norm" is displayed, the commutating speed is NORMAL, when message "FAST" is displayed the commutating speed is FAST. The set up of the commutating speed value is common at all three outputs.

#### Channel status visualisation

This function allows a rapid control of the three sensor channel adjustment. Pressing the SEL pushbutton for at least 2 s the channel, operating mode and tolerance are visualised in a sequential manner.

OUT	1	2	3	Dig1	Dig2	Dig3	Dig4	SET	SEL
■	□	□	■	r	u	n	d	●	○

OUT	1	2	3	Dig1	Dig2	Dig3	Dig4	SET	SEL
□	□	□	□	C	h	-	1	○	●

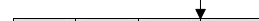

OUT	1	2	3	Dig1	Dig2	Dig3	Dig4	SET	SEL
■	□	□	■	r	u	n	d	●	○

At the end of the sequence the display will indicate the "run" or "rund" operating mode again.

### REMOTE FUNCTIONS

**KEYLOCK function (SET pushbutton block)**  
If at sensor powering the SYNC wire is connected to +Vdc for at least 1s, the *keylock* function is activated and the pushbuttons are no longer available. After the first second, the SYNC input is available for the normal operating modes; if SYNC is high the outputs are deactivated. To deactivate the *keylock*, the sensor has to be turned off and re-powered with the SYNC wire not connected or ground connected (GND).

**SYNC input**  
The SYNC signal can exactly determine the beginning and end of the colour identification. The identification cycle begins after the SYNC signal changes from passive to active and the sensor outputs have to be updated after max. 700µs. All the outputs are deactivated after max. 400µs from an active passage to a passive one.

The connection of the SYNC wire to Vdc corresponds to the passive logic status while SYNC not connected or connected to 0V corresponds to the active logic status. (SYNC passive = Vdc ; SYNC active = 0V)

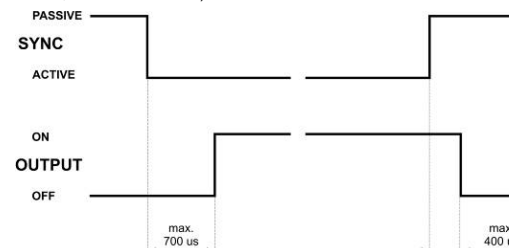

A typical application of the SYNC function is the necessity to detect a particular position in a multi-coloured target while the other area must not be detected. This function can also be used to avoid erroneous detection during target-background transitions.

**RS485 serial connection only for version S65-PA-5-V19-xxxZ**  
The complete sensor remote control is possible using the RS485 line. All the functions such as the channel selection, the tolerance selection and the operating mode can be accessed by means of this serial line. The serial communication parameters are: 9600 baud, no parity, 8 data bits, 1 stop bit. All the commands have to be sent via terminal in an ASCII format as follows:

- **Receiving of the channel status:**  
At any moment, the receipt of the 'r <CR> <LF>' command indicates the sensor configuration.
- **R B G component detection:**  
At the receipt of the 'v <CR> <LF>' comand (at any moment), the 3 components are transmitted in the Rxxx<CR><LF>Bxxx<CR><LF>Gxxx<CR><LF> format where the Rxxx, Bxxx and Gxxx are ASCII strings and one digit identifies the colour (R, B or G) and 4 digits represent the value.
- **Remote setting mode:**  
To access to the remote setting mode, the SYNC input has to remain passive for at least 300ms. The commands available are given below:  
@ <CR> <LF> beginning of the remote setting, passive SYNC  
cx <CR> <LF> channel selection, with x ∈ {1,2,3}  
tx <CR> <LF> tolerance selection, with x ∈ {0,1,2,3,4,5,6,7,8,9}  
mx <CR> <LF> operating mode selection, with x ∈ {1=C,2=C+1}  
e <CR> <LF> configuration sequence activation and configuration saving.  
q <CR> <LF> exit from the remote setting mode without saving configuration.
- If the SYNC input is activated before the 'e' (execute) command is given, the sensor exits the remote setting mode without saving the configuration, similarly to the receipt of the 'q' (quit) command.  
If the SYNC input is active, at the receipt of the @ <CR> <LF> command, the sensor responds with: ?? <CR> <LF>. At the receipt of the q <CR> <LF> commands the sensor transmits ok <CR> <LF>.  
At the receipt of the e <CR> <LF> commands the sensor transmits ok <CR> <LF> in case of correct acquisition, lo <CR> <LF> if the signal is too low, hi <CR> <LF> if the signal is too high.

- **Delay configuration:**  
To access to the delay configuration, the SYNC input has to remain passive for at least 300 ms. The commands available are given below:  
@ <CR> <LF> beginning of the delay configuration, passive SYNC  
dx <CR> <LF> delay selection, with x ∈ {0,1,2,3,4,5}, 0=0ms, 1=5ms  
e <CR> <LF> memorisation of the new delay value  
q <CR> <LF> exit from the delay configuration without saving the configuration.

If the SYNC input is activated before the 'e' (execute) command is given, the sensor exits the remote setting mode without saving the configuration, similarly to the receipt of the 'q' (quit) command.  
If the SYNC input is active, at the receipt of the @ <CR> <LF> command, the sensor responds with: ?? <CR> <LF>. At the receipt of the q <CR> <LF> or e <CR> <LF> commands, the sensor transmits ok <CR> <LF>.

- **Configuration of the commutating speed:**  
To enter the configuration of the commutating speed the SYNC input has to remain passive for at least 300 ms. The available commands are:  
@ <CR> <LF> start of the speed configuration (together with passive SYNC)  
sx <CR> <LF> speed selection, with x ∈ {0=FAST, 1=NORMAL}  
e <CR> <LF> saving of the new speed value  
q <CR> <LF> exit from the delay configuration without saving configuration.

If the SYNC input becomes active before the 'e' (execute) command is given, the sensor exits from the configuration without saving, likewise what happens when the 'q' (quit) command is given.  
If the SYNC input is active, at the receipt of the @ <CR> <LF> command, the sensor responds with: ?? <CR> <LF>. At the receipt of the q <CR> <LF> or e <CR> <LF> commands, the sensor transmits ok <CR> <LF>.

**NOTE:** during the command transmission, the single strings have to follow each other with a delay of at least 1ms.

**DECLARATION OF CONFORMITY**  
We DATASENSOR S.p.A. declare under our sole responsibility that these products are conform to the 2004/108 CEE, 2006/25/CE Directives and successive amendments.

**WARRANTY**  
DATASENSOR S.p.A. warrants its products to be free from defects. DATASENSOR S.p.A. will repair or replace, free of charge, any product found to be defective during the warranty period of 36 months from the manufacturing date. This warranty does not cover damage or liability deriving from the improper application of DATASENSOR products.

DATASENSOR S.p.A. Via Lavino 265  
40050 Monte S. Pietro - Bologna - Italy  
Tel: +39 051 6765611 Fax: +39 051 6759324  
http://www.datasensor.com e-mail: info@datasensor.com

DATASENSOR S.p.A. cares for the environment: 100% recycled paper. DATASENSOR S.p.A. reserves the right to make modifications and improvements without prior notification.