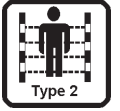

SAFEasy™ TYPE 2 LIGHT CURTAINS

- *Integrated light curtains for BODY PROTECTION*
- *Versions with 2 / 3 / 4 beams*
- *Special slot for device setting*
- *35 x 40 mm compact profile*

SE2-BODY SERIES

The **SAFEasy™** light curtains, according to the IEC 61496-1 e IEC 61496-2 standards, are suitable for detecting the human body when approaching dangerous areas.

Models with different standard heights (500, 800, 900, 1200 mm), with 2, 3, 4 beams and operating distance reaching 50 m are available.

Specific dip-switches, that can be reached through a slot present on the front of the receiver protected by a lid and opened with a simple screwdriver, guarantee rapid and safe device setting.



The operator is thus able to configure, according to the specific needs, the manual or automatic Restart, as well as the Muting and partial Muting functions.

The emitter-receiver units are optically synchronised and contain all the control circuits, inputs and outputs inside the housing.

The **SAFEasy™** light curtains have also integrated the test function, automatically activated every second, without stopping the machine's working cycle.

A wide range of industrial applications, requiring operator safety, can be solved by the **SAFEasy™** light curtains, thanks to the extremely compact dimensions (35x40 mm) and easy connection and installation.

TECHNICAL DATA

Power supply:	24 Vdc ± 20% (SELV/PELV)
Consumption:	70 mA max. / 2.1 W (emitter) 100 mA max. / 3 W (receiver without load)
Light emission:	infrared LED 880 nm
Optic diameter:	Ø 16 mm
Number of controlled beams:	refer to table 1
Optic interaxis:	refer to table 2
Resolution:	refer to table 2
1st beam installation height:	refer to table 3
Through beam operating distance:	0.5 ... 50 m
Receiver inputs:	external switches for Muting, Test, Restart and Override
Receiver indicators:	green / red SAFE / BREAK LED 2 yellow ALIGNMENT LEDs green POWER ON LED
Emitter indicators:	yellow blinking FAILURE LED green POWER ON LED
Output type:	2 PNP
Output current:	0.7 A max. (using both outputs) 0.5 A max. (using one single output) 0.25 A max. (for both outputs from 45°C - 55°C) short-circuit signalling and protection
Response time:	14 ms
Selectable functions:	Total / partial Muting Manual / Automatic Restart refer to table 4
Time-out period:	Muting: 10 minutes Override: 2 minutes
Muting signalling lamp:	24 V 3 W min. (125 mA), 7 W max. (300 mA)
Receiver connection:	8-pole M12 connector
Emitter connection:	4-pole M12 connector
Cable length:	50 m max. (with 50 nF capacitive load)
Safety category:	type 2
Electrical protection:	class 1
Mechanical protection:	IP65 IP67 (connector part)
Housing material:	aluminium with PC Makrolon plastic caps
Weight:	1.2 Kg max. / m of total height
Operating temperature:	-10 ... +55 °C
Storage temperature:	-25 ... +70 °C
Reference standards:	EN 954-1, IEC 61496-1, IEC 61496-2
Certifications:	CE   US LISTED  II3D

TABLES

Model	Beams
SE2 height 500	2
SE2 height 800	3
SE2 height 900	4
SE2 height 1200	4

Table 1: NUMBER OF BEAMS

Model	mm
SE2 height 500	500 / 515
SE2 height 800	400 / 415
SE2 height 900	300 / 315
SE2 height 1200	400 / 415

Table 2: INTERAXIS / RESOLUTION

Model	mm
SE2 height 500	400
SE2 height 800	300
SE2 height 900	300
SE2 height 1200	300

Table 3: 1st BEAM INSTALLATION HEIGHT

ON

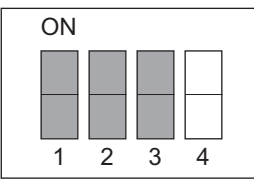

1 2 3 4

GREY dip-switches: total / partial Muting selection
WHITE dip-switches: manual / auto. Restart selection

Table 4: DIP-SWITCH SELECTION

CONNECTIONS

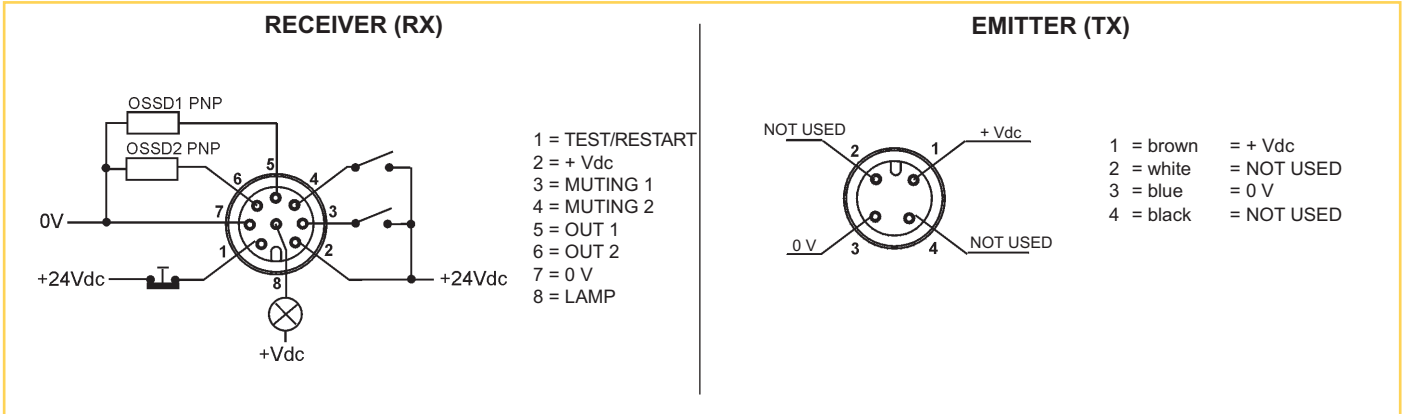

DIMENSIONS

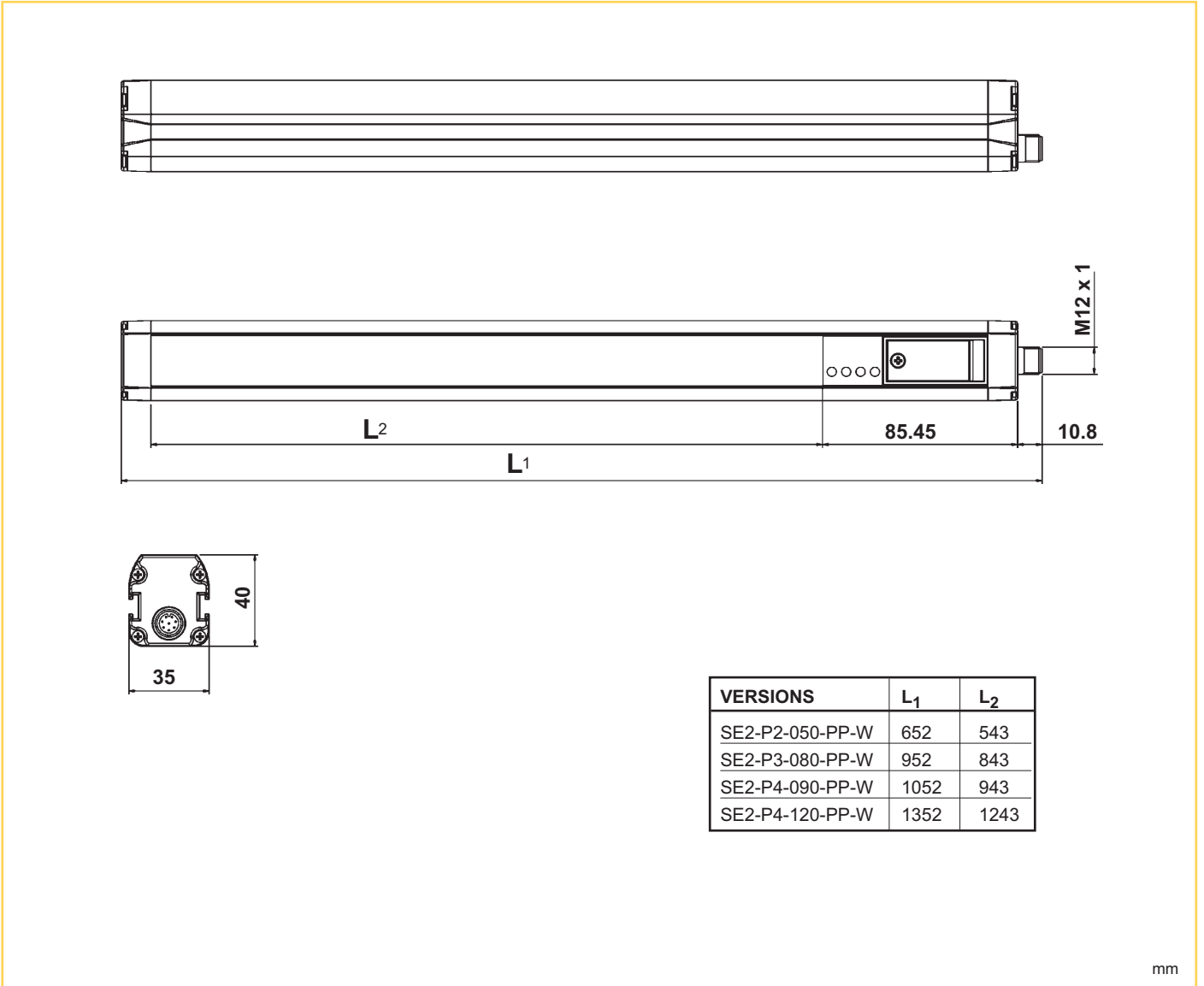



MODEL SELECTION AND ORDER INFORMATION

MODEL	DESCRIPTION	CODE N°
SE2-P2-050-PP-W	type 2 safety light curtain with 2 beams	957101110
SE2-P3-080-PP-W	type 2 safety light curtain with 3 beams	957101120
SE2-P4-090-PP-W	type 2 safety light curtain with 4 beams	957101130
SE2-P4-120-PP-W	type 2 safety light curtain with 4 beams	957101140

ACCESSORY SELECTION AND ORDER INFORMATION

Please refer also to **Safety Device Accessories**

Note: All the accessories have to be ordered separately

SAFETY DEVICES

Distributed by:

HEADQUARTERS

DATASENSOR SpA
via Lavino, 265 - 40050 Monte San Pietro, BO - Italy
Tel. +39 051/6765611 • Fax +39 051/6759324
www.datasensor.com • e-mail info@datasensor.com

Datasensor SpA endeavours to continuously improve and renew its products; for this reason the technical data and contents of this catalogue may undergo variations without prior notice. For correct installation and use Datasensor SpA can guarantee only the data indicated in the instruction manual supplied with the products.