

AZ16 E series

Installation manual

Battery powered Absolute Linear Encoder System

Complete with an Indicator and an external Magnet Sensor with 0.1 mm resolution



Features

- Measuring distances up to 8 meters possible
- Unique definition of the zero point (no further referencing necessary)
- Permanent retention of all data and settings
- Reserve energy up to 3 years
- AUTO-POWER-OFF function with adjustable „switch on“ time
- Switch over for absolute / incremental mode
- Millimeters or Inches operation
- Fraction views in the Inch mode possible
- User friendly menu levels
- Keys can be enabled or disabled individually
- Adjustable reference value and 3 tool offsets
- Symbols individually selectable (mm/inches/arrows etc.)

1. INTRODUCTION	3
2. SAFETY	3
3. DETERMINATION OF THE RAIL AND TAPE LENGTH	4
4. DISPLAY ASSIGNMENT	4
5. THE AZ16E IN OPERATION	4
5.1 Initial operation	4
5.1.1 Detection of measuring direction	4
5.1.2 Referencing	4
5.3 Parameter settings	6
5.4 Parameter list	7
6. BATTERY CHANGE	9
7. MAGNETIC TAPE	10
7.1 Handling	10
7.2 Processing note for sticking	11
7.3 Resistance to chemicals of the magnetic tape	11
7.4 Sticking and cutting	11
8. TECHNICAL SPECIFICATIONS	12
9. DIMENSIONS	13
9.1 Display Unit:	13
9.2 External Magnet Sensor „AZS“:	14
10. INSTALLATION / DISPLAY UNIT	14
11. TYPE DESIGNATION	15
12. LIABILITY EXCLUSION / GUARANTEE	16

1. Introduction

The new linear „Absolute“ encoder and indicator unit AZ16 is based on the proven magnetic measuring principle. According to its battery supply, no wirings are necessary and the systems is able to operate as a complete stand alone unit. The max. possible measuring distance amounts to 8 meters. By using the AUTO-POWER-OFF mode the max. service life span of the battery amounts up to 3 years.

The external magnetic sensor is connected fix to the indicator by a drug chain suitable cable. Further a version with an internal sensor and a guidance rail is available (AZ16I).

Characteristics of the AZ16E (external Sensor):

The system consists of

- an extensive programmable Display unit
- the external Magnet Sensor "AZS", which its cable length is available up to 20 meters
- an absolute coded Magnetic Tape with a max. measuring Length of 8 meters

The AZS sensor is contactlessly moved over the magnetic tape. It is resistant against abrasion, dust, dirt and water (protection class IP 67).

The user must provide and guarantee for a suitable mechanical guiding system, to guide the sensor and keep it along the whole movement in the correct distance (0... 1.5 mm) to the magnetic tape. The sensor must be installed coplanar to the tape.

2. Safety



Please note: Before first commissioning read this installation manual carefully and observe absolutely the installation instructions. The measuring system is only dedicated for recording lengths. The type label is intended for exact identification of the measuring system. The label is situated on the indicator housing. It informs about the exact type designation (see chapter 9), the delivery date and the production number. When contacting the company ELGO Electric GmbH please use these terms.



Attention!

The company ELGO Electric GmbH is not liable for possible damages to machines and or to persons, which can result from defective material at the measuring system and the following circuit. The machine manufacturer is responsible for taking and realizing the necessary safety precautions.

3. Determination of the rail and tape length

Basically the following applies with an order of magnetic tape:

Ordered length of tape = effective measuring distance + 100 mm

For further details see the „Type designation“ at the end of the manual.

4. Display assignment

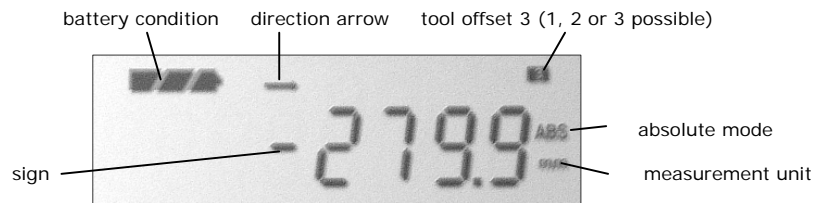

5. The AZ16E in operation

5.1 Initial operation

5.1.1 Detection of measuring direction

The Magnet Sensor „AZS“ and the magnetic tape are provided with a marker, in order to signal the installation direction. The markings of sensor and tape must point to the same direction.

The counting direction (+/-) is reversible in parameter **P01** (see chapter 5.4).

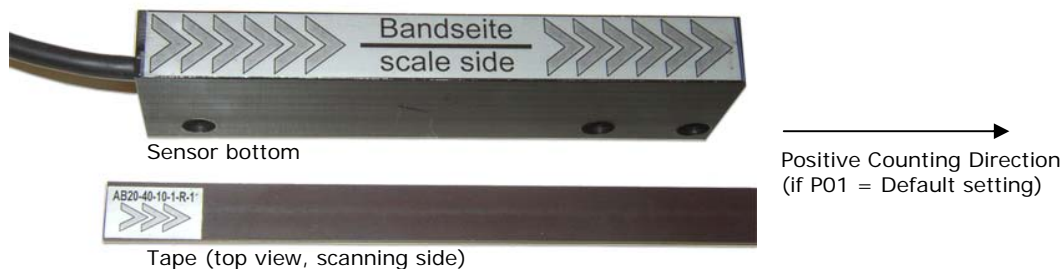

5.1.2 Referencing

Setting the zero-point: A new AZ16E unit shows always the absolute value of the magnetic tape and should be calibrated to the zero point for one time. The reference value default setting in register **P09** is **0**. To assign a zero point to an arbitrary position, move to the desired zero-point and press the buttons **F + Set** together.

Reference value: Alternatively an arbitrary value can be entered in **P09**, to set a demanded reference measurement by pressing **F + Set** together.

5.2 Basic functions (overview)

Switch back from the sleep mode



F

The unit switches into the sleep mode after completion of the adjustable time in register **P04**, if there are no changes in the display value and no key is pressed.

To switch back from the sleep mode, the button **F** must be pressed.

Reference value



F

+



Set

By pressing **F + Set** together, the display sets to the reference value, deposited in register **P09**.

Absolute-/ relative measurement



**Incr/
Abs**

Press **Incr/Abs** to switch over from „absolute“ to „relative“ measurement: The actual value shows „0“ and also „INC“ appears in the display. With a renewed pressing of **Incr/Abs** the display switches back to „absolute“ measurement and the display shows the real absolute value again and „ABS“ also.

Tool offset









Switches over between three adjustable Tool Offsets. These can be deposited in the registers **P10/11/12**. The display appears (right above):

1 , **2** or **3**

The selected tool offset will be added to the actual value.

5.3 Parameter settings

	<p>3 sec.</p> <p>1) Press button F for 3 seconds. → "P01" (Parameter 01) appears in the display window.</p>
	<p>2) Press button F The appropriate parameter value appears in the display</p>
	<p>3) Select the desired decade by pressing Set</p>
	<p>4) Adjust the desired value by using the Incr/Abs button</p>
	<p>5) Press F to select the next parameter Repeat No. 2)... 4) for the next parameter</p>
	<p>3 sec.</p> <p>6) Press F for 3 seconds → The display shows the actual value again</p>

Fraction views in Inch- Mode

	<p>In the inch mode four different fraction views can be selected:</p> <p>Press SET for one time: LSB = 1/64 Inch</p> <p>Press SET for two times: LSB = 1/32 Inch</p> <p>Press SET for three times: LSB = 1/16 Inch</p> <p>Press SET for four times: LSB = 0.001 Inch</p>
---	---

5.4 Parameter list

P 01 / Configuration of system: (default setting = 11100)

X X X X X

- 0 = Positive counting direction
- 1 = Negative counting direction
- 0 = mm operation (0.1 mm resolution)
- 1 = Inch operation (0.1 inches resolution)
- 0 = mm/Inch symbol disabled
- 1 = mm/Inch symbol enabled
- 0 = Arrow symbol for „positive direction“ disabled
- 1 = Arrow symbol for „positive direction“ enabled
- 0 = LCD in standby mode disabled
- 1 = LCD in standby mode enabled (Display "OFF" and battery condition)

P 03 / Decimal place: (default setting = 1)

X = 0...3 (for mm operation only)

P 04 / Auto power off time: (default setting = 10 s)

X X = 0...99 seconds (0 = standby mode disabled)

P 05 / keyboard interlock: (default setting = 111)

X X X

- 0 = button * disabled
- 1 = button * enabled
- 0 = button **Incr/Abs** disabled
- 1 = button **Incr/Abs** enabled
- 0 = button **Set** disabled
- 1 = button **Set** enabled

Parameter list (continuation)

<p>P 08 / Position scaling factor: (default setting = 1.000)</p> <p>0.001 ... 9.999 (the position value is multiplied by the factor adjusted here)</p>
<p>P 09 / Reference value: (default setting = 0.0 mm / 0.000 Inch)</p> <p>- 999999.9 mm ... + 999999.9 mm (- 9999.999 Inch ... + 9999.999 Inch)</p>
<p>P 10 / tool offset 1: (default setting = 10.0 mm / 0.100 Inch)</p> <p>- 999999.9 mm ... + 999999.9 mm (- 9999.999 Inch ... + 9999.999 Inch)</p>
<p>P 11 / tool offset 2: (default setting = 20.0 mm / 0.200 Inch)</p> <p>- 999999.9 mm ... + 999999.9 mm (- 9999.999 Inch ... + 9999.999 Inch)</p>
<p>P 12 / tool offset 3: (default setting = 30.0 mm / 0.300 Inch)</p>

6. Battery change

To change the battery with a standard unit (integrated battery version) remove battery cover on the rear, by pressing the outer edges gently (like shown on the photo). Useful are commercial battery types, size C, 1.5 V) with good quality. All values and settings remains in case of changing the batteries.



Please pay attention to the correct polarity!
The polarity is marked inside the housing.

7. Magnetic Tape

The magnetic tape consists of 3 components (see picture 1)

- a magnetized flexible rubber tape (Pos. 3), which is connected factory made with a
- steel band (Pos. 5) and a
- covering band (Pos. 1) , which is intended for the protection of the rubber tape.
- For mechanical protection of the magnetic tape the covering band must be stuck on. Additionally it protects the magnetic tape from extreme external magnetic influences. To reach a complete adhesion between the several materials a special sticky tape is used (Pos. 2, Pos. 4, Pos. 6).

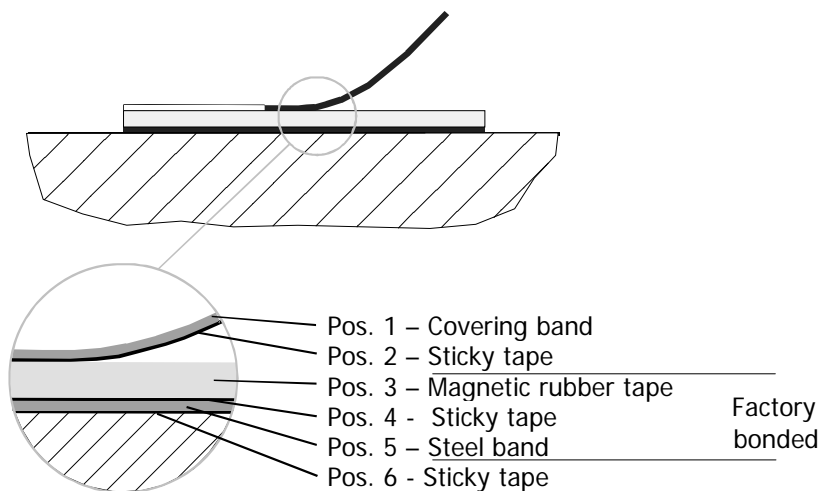

Picture 1: Components of the magnetic tape

7.1 Handling

To avoid tension in the magnetic tape, don't tuck or twist it. Avoid also to store or to handle it with the magnetic rubber tape to the inside (min. bend radius 150 mm).

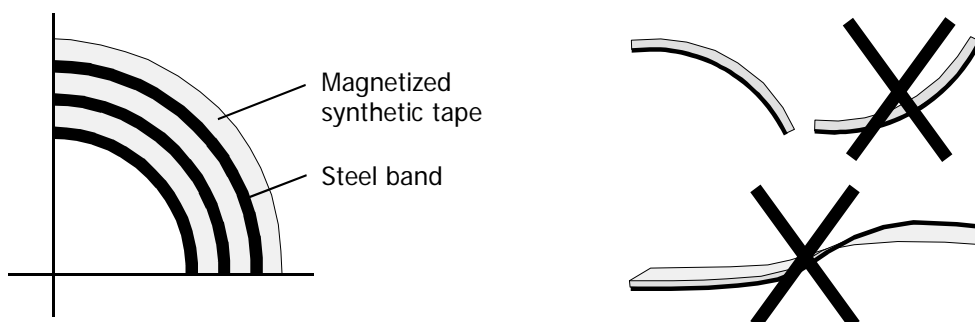

Picture 2: Storage and transport

7.2 Processing note for sticking

The provided sticky tapes stick well on clean, dry and plain surfaces. The more pollution exists the more proper the surface has to be. A surface roughness of $R_a \leq 3,2$ ($R_z \leq 25 / N8$) is recommendable. Typical solvent for cleaning surfaces are a 50/50 - isopropyl-alcohol / water mixture or heptane. The surfaces of materials as copper, brass etc. should be sealed to avoid an oxidation. The stability of the adhesion is directly depending on the contact, which the adhesive develops to the stuck surfaces. A high pressure results in a good surface contact.

The optimal sticking temperature is between + 21°C and 38°C.

Avoid colder sticking surfaces than + 10 °C, because in this case the adhesive becomes to hard and perhaps a sufficient immediate adhesion is hardly to achieve. After proper sticking the stability of the connection is ensured also when the temperature is below zero. The final tackiness of a sticking is from experience reached after approximately 72 hours (at + 21 °C). For sticking use only the provided sticky tape.

7.3 Resistance to chemicals of the magnetic tape

The magnetic tape shows **no or only small effects** when contacting permanently the following materials after 2 to 5 years: Formic acid, Glycerol 93°C, Linseed oil, Soy beans oil, Cotton seed oil, N-hexane, Lactic acid, Formaldehyde 40%, Isooctane, Petroleum.

Poor to medium effects result when contacting permanently the following materials after approximately 1 year: Acetone, Gasoline, Acetic acid 30%, Olein acid, Acetylene, Steam, Acetic acid, pure Acetic acid, Sea water, Ammonia, Acetic acid 20%, Isopropyl ether, Stearic acid 70°C anhydrous, Kerosene.

Strong effects result when contacting permanently the following materials after 1 to 5 months: Benzene, Nitric acid 70%, Turpentine, Toluene, Lacquer solvent, Nitric acid red and Vitriolic, Carbon Tetrachloride, Trichloroethane, Nitrobenzene, Hydrochloric acid 37% and 93°C, Tetrahydrofuran, Xylene.

7.4 Sticking and cutting



Attention! When sticking the magnetic tape pay attention to the marks on the magnetic tape. A faulty installation delivers incorrect values. An already stuck magnetic tape is ruined after removing and can't be used again. Observe also the counting direction of the measuring system.

The magnetic tape and the covering band must be cut to the exact length before sticking:

$$\text{Magnetic tape length} = \text{measuring length} + 0.1 \text{ m}$$

Preferably the magnetic tape should be stuck into a nut or aligned to an edge.

Procedure for sticking:

1. The magnetic tape is already factory bonded with the steel band, in between is a double sided sticky tape. Stick the provided sticky tape onto the carrier side (= steel band).
2. Now adjust the magnetic tape and stick it onto the surface. The best way to stick the magnetic tape is to do it in two steps. Remove the first half of the adhesive film from the sticky tape and stick it, then do the rest length.
3. Then stick the sticky tape onto the covering band. It is not important on which side of the covering band the sticky tape is stuck on.
4. Stick the covering band onto the visible brown magnetic rubber tape

8. Technical specifications

AZ16E (battery powered absolute encoder and indicator system with an external sensor)	
POWER SUPPLY	1 commercial battery size C (1.5 V)
Battery service life	1... 3 years (depends on adjusted switch-on time)
Distance Sensor - Tape	max. 1.5 mm
Resolution of encoder	0.1 mm
Measuring units	mm's or INCHES
Measuring length	max. 8 m
Principle of Measurement	Magnetic, absolute
Character of Measurement	Linear, no rotative movements possible
LCD-Display	6 Decades, height = 8 mm, with battery condition, signs and symbols
Keypad	Membrane keypad
Operating temperature	+ 5... + 50° C
Stock temperature	0... 70° C
Humidity	Not condensing, max. 80 %
Altitude	max. 2000 m above sea level
Protection class (display unit)	IP 43 (installed state)
Outer dimensions	W x H = 96 x 72 mm
Cut out	W x H = 93 x 67 mm
Depth	(install depth) 37 mm (total depth) 43 mm
Protection class (sensor)	IP 67
Dimensions of sensor	(see drawing on page 13)
Magnetic tape for AZ16	
Code	Absolute, single track system
Extension coefficient	$a = 16 \times 10^{-6} \text{ K}^{-1}$
Linear extension	$\Delta L = L \times a \times \Delta\theta$ (L= measuring length in meters)
Dimensions (W x H)	10 mm x ca. 1.8 mm
min. bend radius	150 mm
Operating temperature	0... + 50° C
Protection class	IP 67

9. Dimensions

9.1 Display Unit:

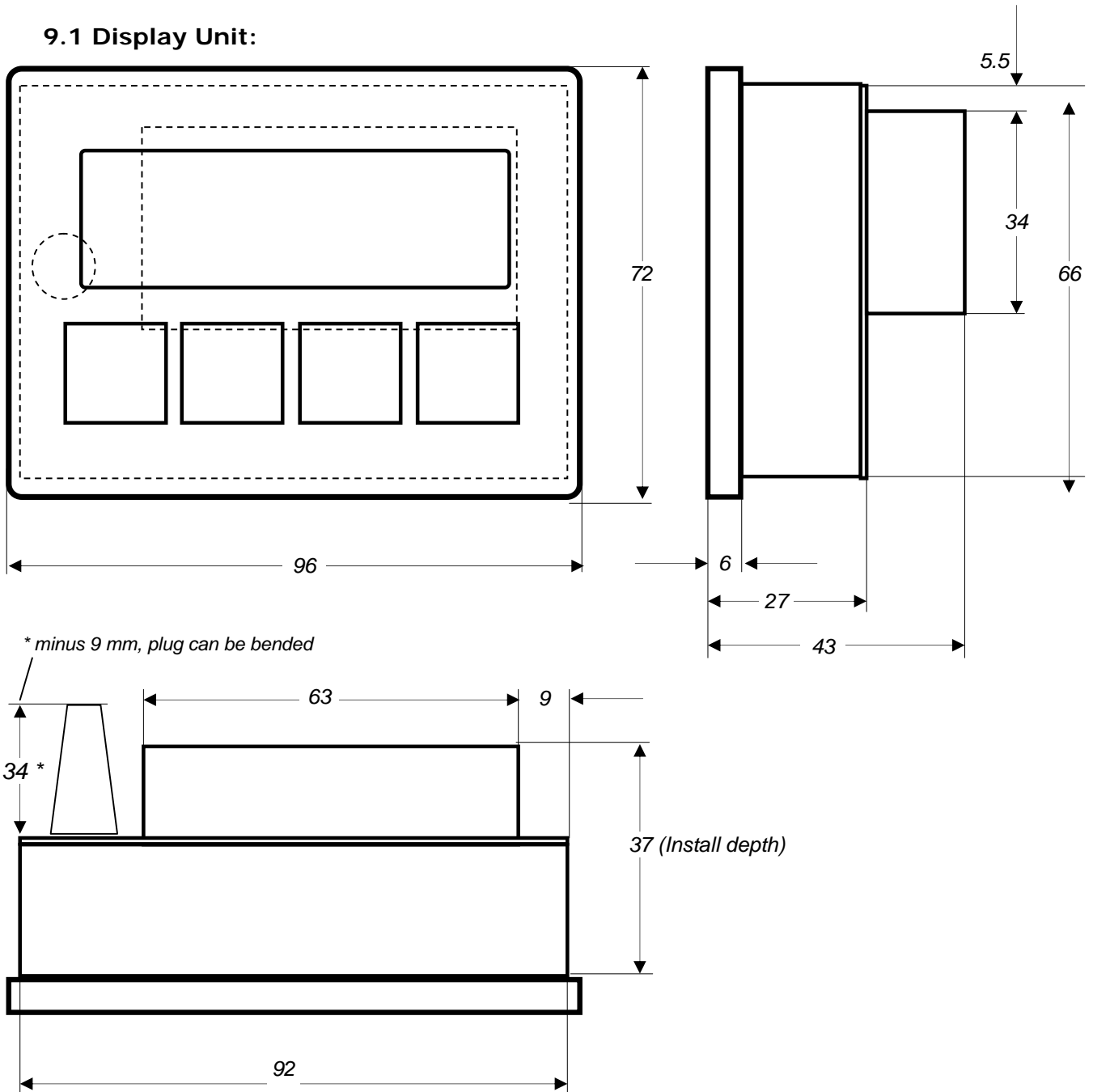

Panel cut out: B x H = 93 x 67 mm

9.2 External Magnet Sensor „AZS“:

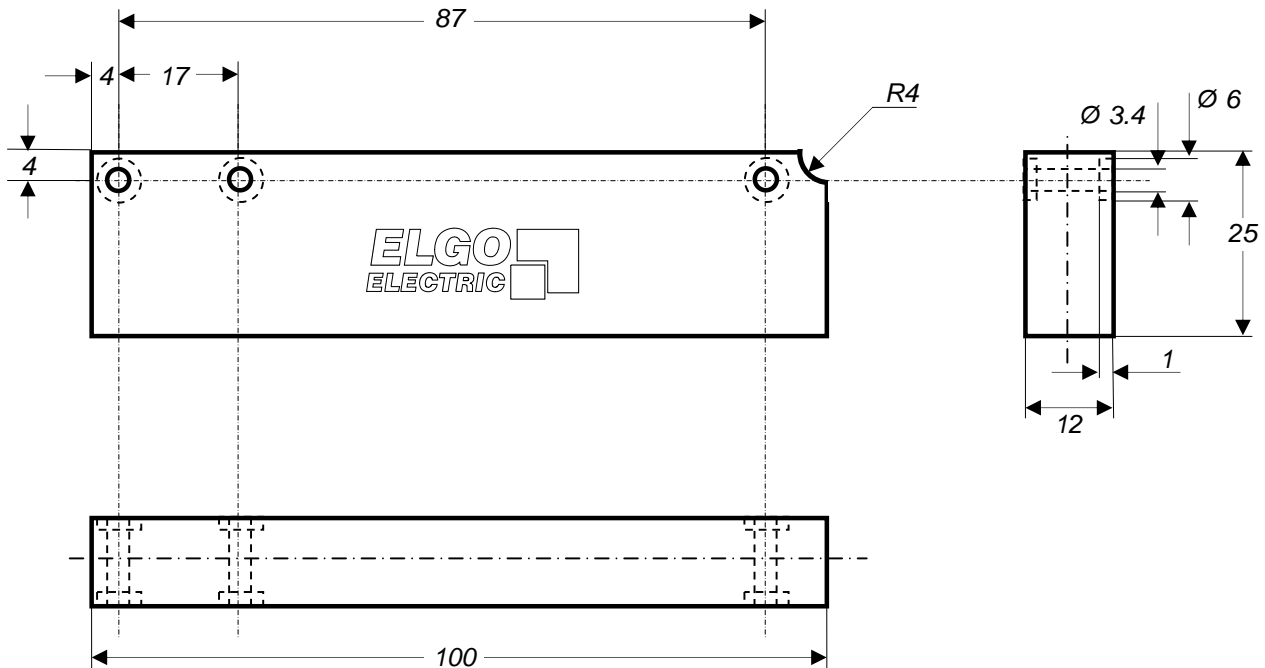

10. Installation / Display Unit

For mounting into a panel serves 2 small mounting plates with grub screws (included in the delivery, see image right).

The unit must be pushed from the front into the cut-out and fixed from the rear by the grub screws at the instrument panel then.

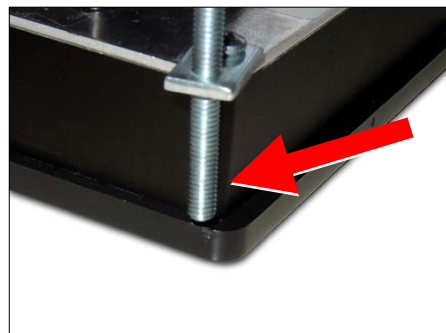

11. Type designation

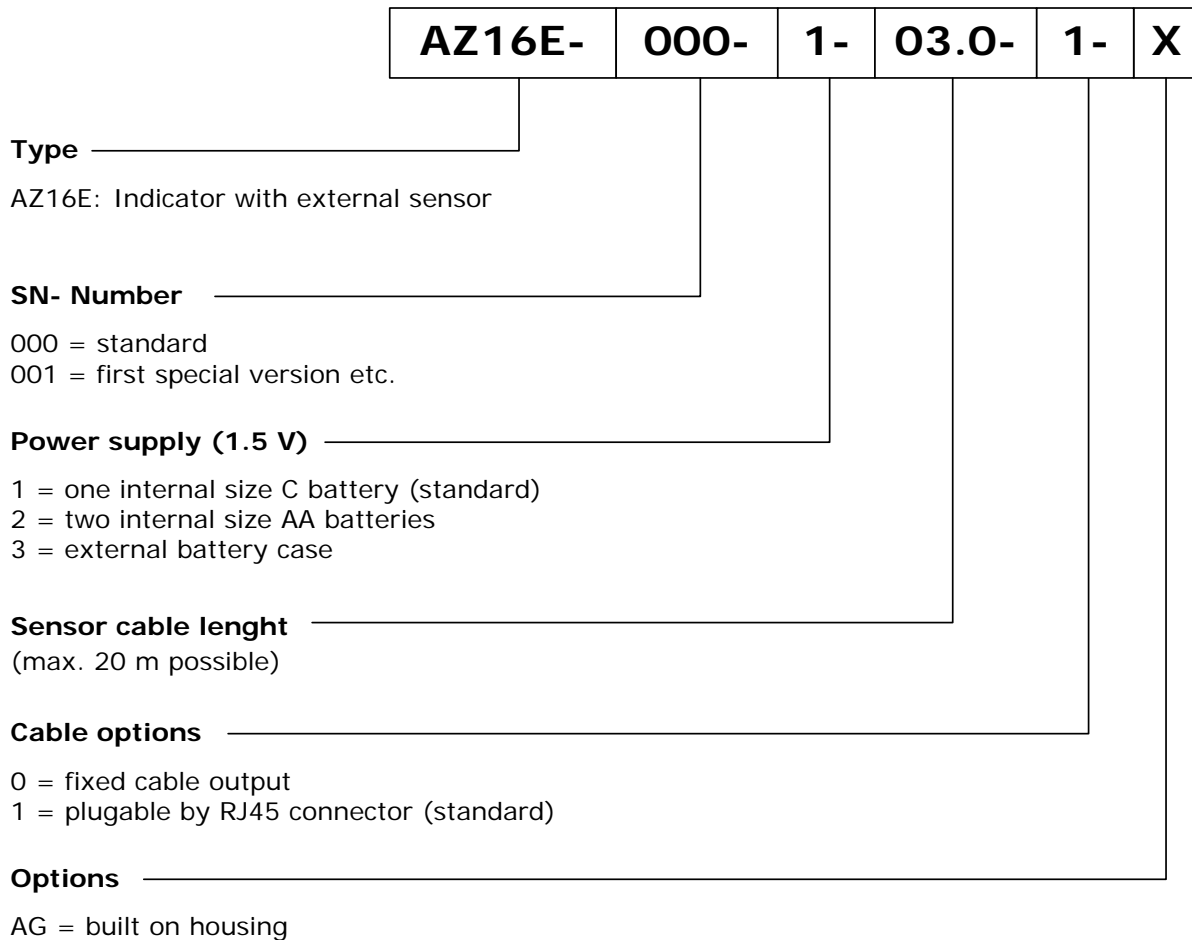

Magnetic tape for AZ16E

Type: **AB20-40-10-1-R-11 - Desired Length*** please indicate in **X.XX** meters

*) Desired length = measuring length + 0.1 m

12. Liability exclusion / Guarantee

We have checked the contents of this instruction manual carefully, to the best of our knowledge and belief for conformity with the described hardware and software. Nevertheless errors, mistakes or deviations can not be excluded, therefore we do not guarantee complete conformity. Necessary corrections are included in the subsequent editions.

We appreciate your ideas and improvement suggestions very much.

Reprint, duplication and translation, even in extracts, are only allowed with a written authorization by the company ELGO Electric GmbH. Our objective is to improve our products constantly, therefore we keep all rights reserved for any technical modifications without any notice.

ELGO Electric does not assume any liability for possible errors or mistakes.

The guarantee period is one calendar years from the date of delivery and includes the delivered unit with all its components. ELGO Electric GmbH will at its option replace or repair without charge defects at the unit or the included parts, verifiable caused by faulty manufacturing and/or material in spite of proper handling and compliance to the instruction manual.

Damages verifiably not caused by ELGO-Electric GmbH and due to improper handling are excluded from any guarantee e.g. by applying faulty voltage, diffusion of liquid into the interior of the engine, using force, scratching the surface, chemical influences etc.!

