

Operation manual

SERIES EMAX2

Magnetic Absolute Length Measuring System with 0.01 mm Resolution



- Absolute measuring
- Direct contact free measurement
- Up to 10 m measuring length (20 m on request)
- Resolution 0.01 mm
- Changes of position are also recognized without voltage – no calibration necessary
- Automatically recognition of too big distance between sensor and magnetic tape
- Additional incremental signals for dynamic drive mechanism available

1	General	3
1.1	Information Operation Manual.....	3
1.2	Explanation of Symbols.....	3
1.3	Statement of Warranties.....	4
1.4	Demounting and Disposal.....	4
2	Product Features	5
2.1	Functional Principle.....	5
3	Safety	6
3.1	General Cause of Risks.....	6
3.2	Personal Protective Equipment.....	6
3.3	Conventional Use.....	6
4	Technical Data	7
4.1	Dimensions EMAX2.....	8
4.2	Dimensions EMAX2 with FW2080.....	9
5	Transport and Storage	10
5.1	Safety Instructions for Transport, Unpacking and Loading.....	10
5.2	Handling of Packaging Material.....	10
5.3	Check of Transport.....	10
5.4	Storage.....	10
6	Installation / Commissioning	11
6.1	Mounting of the Sensor Head.....	11
6.2	Pin Connections.....	12
6.3	Interfaces.....	13
6.3.1	RS422 Standard (Option 420) & RS232 (Option 230).....	13
6.3.2	RS422 Adressable Version (Option A20).....	14
6.3.3	Connection to a RS422 Master.....	16
6.3.4	SSI - (Option SB0 or SG0).....	16
6.3.5	CANopen - (Option CA0).....	17
6.3.6	CAN BASIC ELGO - (Option CN0).....	18
6.3.7	Sine Cosine Incremental Signals (Option SC50).....	20
6.3.8	Terminating Impedance.....	21
7	Options	22
7.1	Magnetic Tape.....	22
7.1.1	Handling.....	22
7.1.2	Processing Note for Sticking.....	23
7.1.3	Resistance to Chemicals of the Magnetic Tape.....	23
7.1.4	Sticking and Cutting.....	23
8	Operation	24
8.1	Offset.....	24
9	Interference	24
9.1	Security.....	24
9.2	Electrical Interference Suppression.....	25
9.3	Restart after Fault Clearance.....	25
10	Maintenance	25
11	Type Designation EMAX2	26
12	Accessories	28
13	Index	29

1 General

1.1 Information Operation Manual

The manual contains important information regarding the handling of the indicator.
For your own safety please note all safety warnings and instructions.

Precondition for safe operation is the compliance with the specified safety and handling instructions.
Moreover, observe the existing local accident prevention regulation and general safety rules.



Please read the operation manual carefully before starting to work. The manual should be kept accessible at anytime. The illustrations in the manual are for better representation of the facts they are not necessarily to scale and can be slightly different to the actual construction.

1.2 Explanation of Symbols

Warning notices are characterised by symbols in the operation manual.
The notes will be introduced by signal words to express the magnitude of the danger.

Follow these advices in order to avoid accidents and injuries to persons and property.

Warning notices:

	<p>DANGER! This symbol in connection with the signal word „Danger“ indicates an immediate danger for the life and health of persons. Failure to heed these instructions can result in serious damage to health and even fatal injury.</p>
	<p>WARNING! This symbol in connection with the signal word „Warning“ indicates a possible danger to the life and health of persons. Failure to heed these instructions can result in serious damage to health and even fatal injury.</p>
	<p>ATTENTION! This symbol in connection with the signal word „Caution“ indicates a possibly dangerous situation. Failure to heed these instructions can lead to minor injury or property damage.</p>

Specific safety instructions

	<p>DANGER! ...marks perilous situations by electricity. By non-observance of the safety instructions the possibilities of death or severe injuries exist. The operations have to be carried out only by an electrician.</p>
-------------------------------------------------------------------------------------	----------------------------------------------------------------------------------------------------------------------------------------------------------------------------------------------------------------------------------------

Tips and recommendations:**NOTE!**

Here you can see highlights, useful tips, information and recommendations for efficient and trouble-free operation.

1.3 Statement of Warranties

The warranty conditions are in a separate document in the sales documents.

Guarantee

The producer guarantees the functional capability of the process engineering and the selected parameter. The period of warranty is one year and begins with the date of delivery. The warranty (1 year) is beginning with the date of purchase.

1.4 Demounting and Disposal

Unless otherwise authorized, dispose the item considering the safety and environmental instructions.

Before demounting

- Disconnect the power supply
- Secure against re-start
- Disconnect supply lines physically and discharge remaining energy
- Dispose operating supplies with respect to the environment

Disposal

Recycle the decomposed elements:

- Collect metal scrap
- Electronic components in electronic scrap
- Recycle plastic parts
- Dispose the rest of the components according to their material consistence

**ATTENTION!**

Wrong disposal → damage caused to the environment!
Electronic waste, electronic components, lubricants and operating supplies are liable to treatment of hazardous waste.
Only approved specialized companies should perform disposal.



Local authorities and waste management facilities provide information about environmentally suitable disposal.

2 Product Features

The series **EMAX2** is an absolute length measuring system. Sensor and translator and interpolation unit are together in one housing. The magnetic tape of series EMAB is paste up to a plain area. The **EMAX2** can be mounted with a max. distance of 1.5 mm. (2.0 mm sensor distance to the magnetic tape with reduced measuring accuracy)

The absolute length measuring system has the following advantages:

- no reference necessary
- direct contact free measurement
- distance between sensor and magnetic tape can be between 0.1... 2.0 mm
- up to 20 m measuring length (on request)
- high resolution 0.01 mm
- repeat accuracy +/- 1 increment
- inured against dirt

The following interfaces are available (RS422, addressable RS422, RS232, SSI, CANopen (DS406), CAN BASIC ELGO (CNO)).

Typical applications are handling systems, conveyor and storage technology, hydraulic presses, stamping machines, casting machines, linear slides, linear drives and pick and place systems.

The guided version is delivered completely with magnetic tape guide and guiding wagon.

2.1 Functional Principle

A Hall sensor and a magneto-resistive impedance measuring bridge are guided over a two-track magnetic tape with a fine-interpolation trace and an absolute trace. Together with the sensor line the absolute track provides an absolute value and the fine-interpolation trace provides together with the interpolation electronic the measuring systems high resolution.

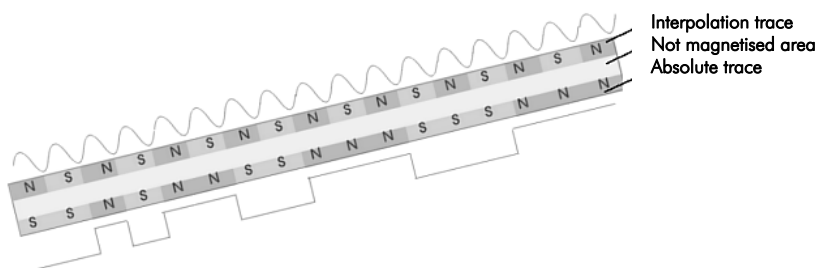

Picture 1: Functional principle **EMAX2**

Pic. 2 shows two magnetic traces, with north pole and south pole magnetization. The fine interpolation trace encloses alternately north and south pole traces with a distance of 5 mm, these are scanned with resistance bridges and provide a resolution of 0.01 mm. The absolute value provides the sensor line with 16 single Hall sensors, these sensors are scanning the code sections of the north and south poles. The absolute value on the magnetic tape recurs every 10 m.



Picture 2: Coding

3 Safety

3.1 General Cause of Risks



This chapter gives an overview about all important safety aspects to guarantee an optimal protection of employees.

Non-observance of the instructions mentioned in this operation manual can result in hazardous situations.

3.2 Personal Protective Equipment

Employees should wear protective clothing during installation of the device to minimize the risk of accidents. Change into protective clothing before beginning the work process. Also observe any labels in the operating area regarding protective clothing.

Protective clothing:

	<p>Safety working clothing ... is close-fitting ... is tear proof ... has tight sleeves without distant parts</p> <p>Also wear no rings, necklaces or other jewellery.</p>
	<p>Protective gloves ... For protecting the hands against abrasion and cuts.</p>

3.3 Conventional Use

The ELGO length measuring system **EMAX2** is for the limited purpose as described in this manual:

	<p>CAUTION! Danger through non-conventional use! Non-intended use and non-observance of this operation manual can lead to dangerous situations.</p> <p>Therefore:</p> <ul style="list-style-type: none"> ▪ Use EMAX2 only as described ▪ Strictly follow this manual <p>Avoid in particular: Remodelling, refitting or changing of the device or parts of it with the intention to alter functionality or scope of the device.</p>
-------------------------------------------------------------------------------------	-----------------------------------------------------------------------------------------------------------------------------------------------------------------------------------------------------------------------------------------------------------------------------------------------------------------------------------------------------------------------------------------------------------------------------------------------------------------------------------------------------------------

ELGO is not liable for any damages resulting from improper use of the product. The operator is liable for all damages during non-conventional use.

4 Technical Data

Mechanical Data	
Measuring principle	absolute
Repeat accuracy	+/- 1 increment
System accuracy in μm at 20 °C	+/- (150 + 20 x L) (type design. 010) +/- (50 + 20 x L) (type design. F10) L = effective measuring length
Distance from the sensor to magnetic tape	max. 1.5 mm, 2.0 mm with reduced accuracy
Basic pole pitch	5 mm
Sensor housing material	zinc diecasting
Housing dimensions	Sensor: L x W x H = 75 x 24 x 26 mm Sensor with guide carriage: L x B x H = 100 x 34 x 48 mm
Necessary magnetic tape	Meas. length 10 m: AB20-50-10-2-R-11 Meas. length 20 m: AB20-50-10-2-R-12
Max. measuring length	EMAX : up to 10 m EMAL : up to 20 m
Cable connection	open cable end
Weight	EMAX2: ca. 100 g without cable cable: ca. 60 g per meter
Ambient Temperature	
Storage temperature	-25... +85 °C
Operation temperature	-10... +70 °C (-25... +85 °C) on request
Protection class	IP40 (Standard) IP65 (Option V)
Electrical Data	
Power supply	10... 30 VDC +/- 10 %
Periodic and random deviation	10 - 30 V: < 10%
Current consumption	max. 150 mA
Interfaces	SSI-Interface, CANopen (DS406), CAN BASIC ELGO (CNO), RS422, addressable RS422
Resolution	0.01 mm
Max. output frequency	4 m/s
Sensor cable	1.5 m standard cable length, others on request, drag chain compliant

4.1 Dimensions EMAX2

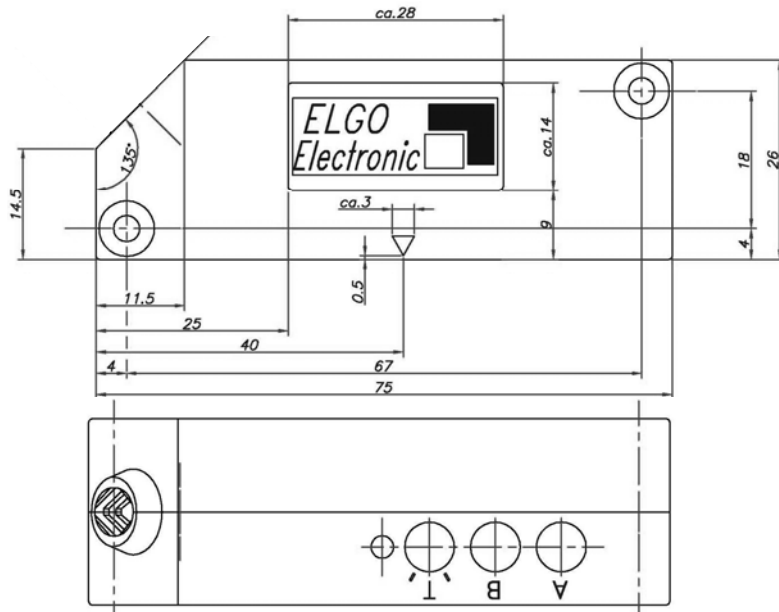

* The amount of decode switches is depending on the interface

Front view

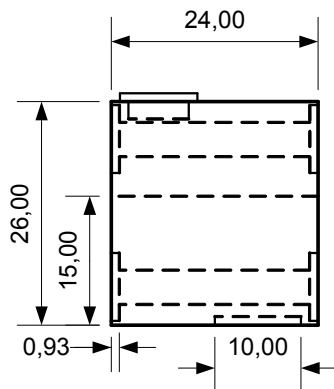

Rear view

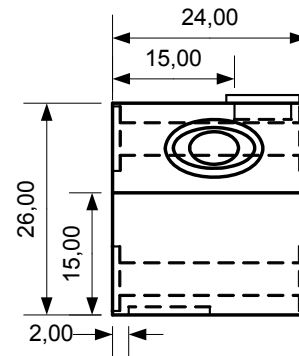

4.2 Dimensions EMAX2 with FW2080

Side view

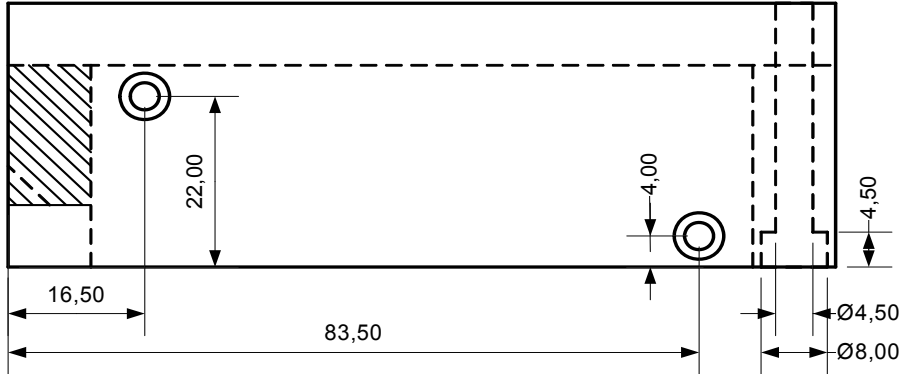

Top view

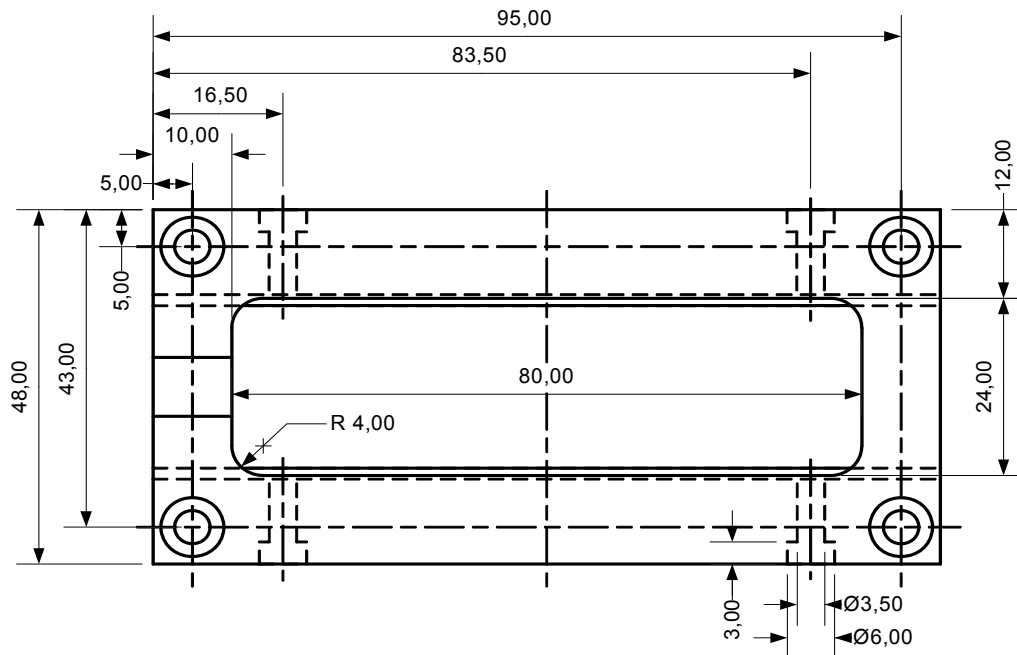

Front view

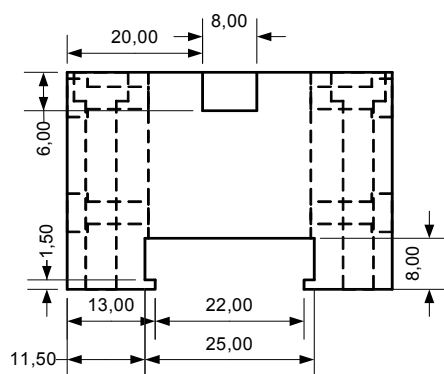

5 Transport and Storage

5.1 Safety Instructions for Transport, Unpacking and Loading

**ATTENTION!**

Professional transport only.
Do not throw, hit or fold the package.

5.2 Handling of Packaging Material

Adverts for proper disposal refer to chapter demounting and disposal.

5.3 Check of Transport

Examine delivery immediately after receiving for completeness and transport damages.

In case of externally recognizable transport damages:

- Do not accept the delivery or do accept under reserve
- Note extent of damages on the transportation documents or on the delivery note
- File complaint immediately

**NOTE!**





Claim any damages you recognize as soon as possible. The claims for damage must be filed in the lawful reclaim periods.





5.4 Storage





Store device only under following conditions:

- Do not store outside
- Keep dry and dust-free
- Do not expose to aggressive media
- Protect from direct sun light
- Avoid mechanical shocks
- Storage temperature: -25 °C up to +85 °C
- Relative humidity: 80 % non-condensing
- Inspect packages regularly if stored for an extensive period of time (> 3 months)

6.2 Pin Connections

Signal cable	Function RS422 (420, A20)	Function RS422 (420, A20) Incremental HTL	Option RS232 (230)	Option RS232 (230) Incremental HTL	Option RS232 (230) Incremental TTL
white	0 V / GND	0 V / GND	0 V / GND	0 V / GND	0 V / GND
brown	+ 10-30 VDC	+ 10-30 VDC	+ 10-30 VDC	+ 10-30 VDC	+ 10-30 VDC
yellow	TX +	RX +	RX	RX	RX
orange	TX -	TX -	TX	TX	TX
green	RX +	RX +	-	-	channel B inv.
violet	RX -	RX -	-	-	channel A inv.
grey	-	channel A	-	channel A	channel A
black	-	channel B	-	channel B	channel B
shield	PE* 	PE* 	PE* 	PE* 	PE* 

Signal cable	Option SSI (SG0, SB0)	Option SSI (SG0, SB0) Incremental HTL	Option CAN (CA0, CN0)	Option CAN (CA0, CN0) Incremental HTL	Option CAN (CA0, CN0) Incremental TTL
white	0 V / GND	0 V / GND	0 V / GND	0 V / GND	0 V / GND
brown	+ 10-30 VDC	+ 10-30 VDC	+ 10-30 VDC	+ 10-30 VDC	+ 10-30 VDC
yellow	TX Data +	TX Data +	CAN high	CAN high	CAN high
orange	TX Data -	TX Data -	CAN low	CAN low	CAN low
green	CLK Clock +	CLK Clock +	-	-	channel A inv.
violet	CLK Clock -	CLK Clock -	-	-	channel B inv.
grey	-	channel A	-	channel A	channel A
black	-	channel B	-	channel B	channel B
shield	PE* 	PE* 	PE* 	PE* 	PE* 

Signal cable	Option SSI (SG0, SB0) Sine/Cosine SC50	Option SSI (SG0, SB0) Incremental TTL	Function RS422 (420, A20) Sine/Cosine SC50	Function RS422 (420, A20) Incremental TTL
white	0 V / GND	0 V / GND	0 V / GND	0 V / GND
brown	+ 10-30 VDC	+ 10-30 VDC	+ 10-30 VDC	+ 10-30 VDC
grey	TX Data +	TX Data +	TX +	TX +
pink	TX Data -	TX Data -	TX -	TX -
yellow	CLK Clock +	CLK Clock +	RX +	RX +
green	CLK Clock -	CLK Clock -	RX -	RX -
blue	Sine +	channel A	Sine +	channel A
red	Sine -	channel A inv.	Sine -	channel A inv.
black	Cosine +	channel B	Cosine +	channel B
violet	Cosine -	channel B inv.	Cosine -	channel B inv.
shield	PE* 	PE* 	PE* 	PE* 

*) Connect shield only at the device!

6.3.2 RS422 Adressable Version (Option A20)

Protocol of an addressable **EMAX2** version 1.4

The device address can be adjusted by a decoding switch which is located behind a protection cap on the top of the sensor housing:

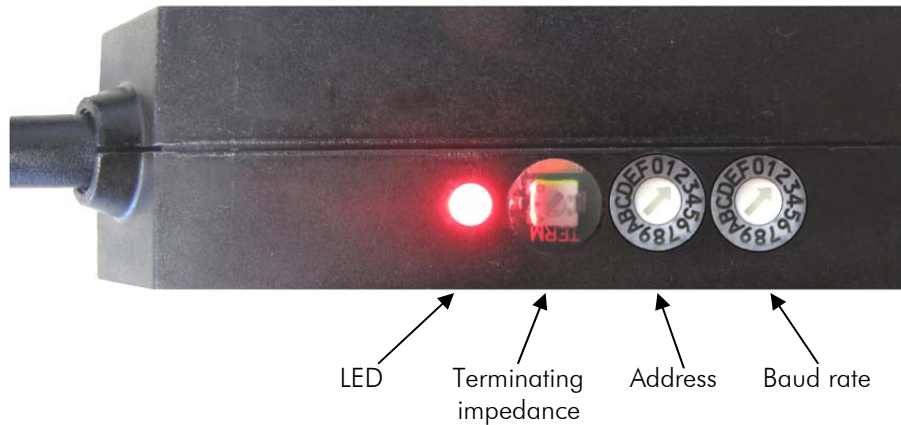

Position	Address
0	0B
1	0C
2	0D
3	0E
4	0F
5	10
6	11
7	12
8	13
9	14
A	15
B	16
C	17
D	18
E	19
F	1A

General format of a message **to** the EMAX:

0x02	Byte1	Byte2	Byte3	0x03
STX			check	ETX

0x02 (STX) starts a message

0x03 (ETX) close the message

Byte3 (check) is the arithmetic sum of 0x02(STX), Byte1 and Byte2.

ETX is not included in the checksum

General format of a message **from** the EMAX:

0x02	Byte1	Byte2	Byte3	Byte4
STX				

Position-request **from** the EMAX with address i:

Message to the EMAX

0x02	0x04	i	check	0x03
STX			check	ETX

0x04 characterizes the message as position-request

i is the address of the requested EMAX2 (i = 0x0b... 0x7f).

Answer of the requested EMAX:

0x02	PosHigh	PosMid	PosLow	EMAX-Address
-------------	----------------	---------------	---------------	---------------------

The position value consists of 3 byte:

PosLow (bit 0... bit 7), PosMid (bit 8... bit15), PosHigh (bit16...bit23).

Bit 0 has the value 10 μ m. Position-values are always smaller than 0xffff00.

Please note: The last byte is no ETX, like in all the other messages, but the EMAX2 address.

Interrogation of the address of an **EMAX2**:

Connect always only a single **EMAX2** to be interrogated via RS422/RS232 converter to COM port of a PC.

Message to the EMAX:

0x02	0x05	0x05	0x0c	0x03
STX	address request		check	ETX

Answer of the EMAX:

0x02	0xff	0xff i	0x03
STX		EMAX address	ETX

Note: The combination 0xff 0xff does not appear in normal mode for position answers of EMAX2 (directly after STX) It is a sign for a special message not a position (in this case with $0x0b \leq i \leq 0x7f$ it is the answer to the interrogation of the address).

Negative answer: If one of the described operations failed for some reasons, EMAX2 gives a negative answer with a concerning error code.

EMAX answers:

0x02	0xff	0xff	Err	0x03
STX	0xff	0xff	Error Code	ETX

With Err = 0x04... 0x0a

Description of the error messages of an addressable **EMAX2**:

Code	Description
0x04	Wrong succession of bytes sent to EMAX2 for example if the 4. byte after the STX is no ETX or the byte after STX is not 0x04, 0x05 or 0x06.
0x05	Receive Error: Error concerning the interface (for example if there has been sent a message with a wrong baud rate etc.)
0x06	Invalid EMAX address – appears after trying to assign an address smaller 0x0b or bigger 0x7f to EMAX2.
0x07	EMAX2 has forgotten its address - check of internal redundant stored address of EMAX2 failed, this error message is sent at power up immediately if an error in reading EEPROM is detected or if the internal redundant stored address does not fit.
0x08	Internal store error of address in EEPROM.
0x09	Error in calculation of position (No tape, tape damaged or to big distance)
0x0a	Check-Sum-Error - Check-Sum of a message sent to EMAX2 is wrong

6.3.3 Connection to a RS422 Master

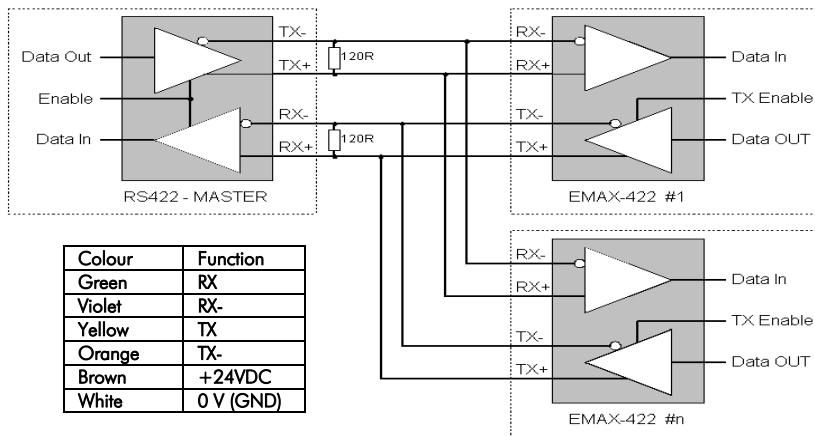

6.3.4 SSI - (Option SB0 or SG0)

Principle of the function: If the clock is not interrupted for the time $T_m - T/2$ (output of further 25 periods), the shift register clocks once again the same data value (error recognition in evaluation).

Some encoders contain a Power Failure Bit (PFB):

With EMAX the PFB is always „low“.

Read out of the data (2 times with 25 clocks):

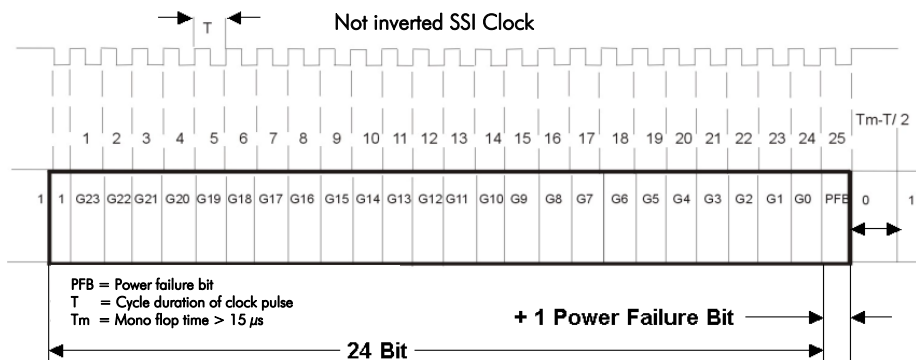

By using the decoding switch, which is located behind a protection cap on the top of the sensor, the data format of the SSI interface can be changed over with the help of a micro screwdriver from Binary code to Gray code.

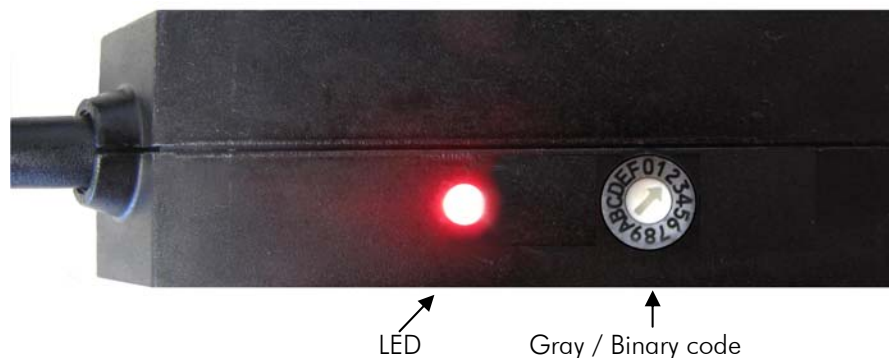

Position	Code
F	Binary
0	Gray

Switch position:
 0 → Gray code
 1 → Binary code

6.3.5 CANopen - (Option CA0)

Interface / Protocol:

As standard the EMAX2 measuring system is equipped with a CANopen standard interface DS406, when ordering option CA0.

The following identifiers are given:

CAN - Identifier

(4 Byte telegram)

180 (16) = Identifier

First 4 bytes = Position (resolution 0.01 mm), bit rate 250 KB/s

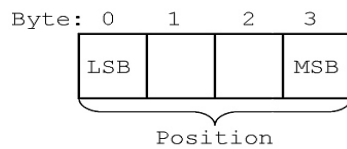

The CAN-Identifier can be adjusted in the range of 181₍₁₆₎ to 18F₍₁₆₎ by a decoding switch, which is located behind a protection cap on the top of the sensor housing:

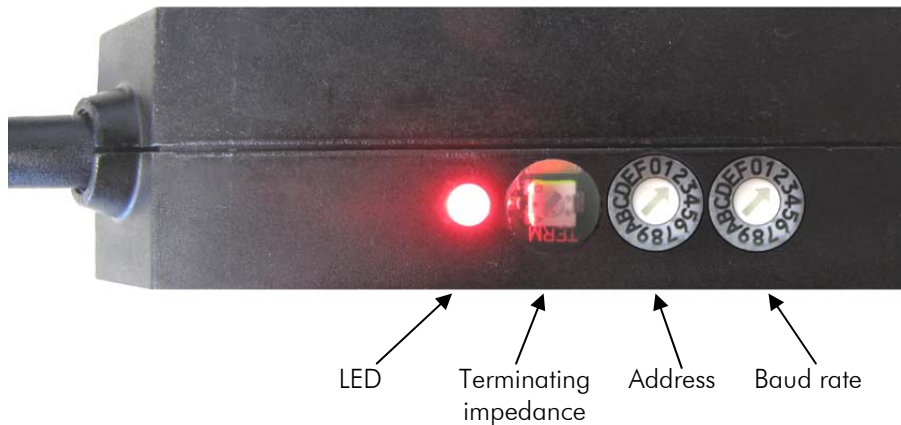

Position	CAN Identifier
0	1fe
1	181
2	182
3	183
4	184
5	185
6	186
7	187
8	188
9	189
A	18A
B	18B
C	18C
D	18D
E	18E
F	18F

6.3.6 CAN BASIC ELGO - (Option CN0)

Interface / Protocol:

On request the EMAX2 measuring system is equipped with a CAN interface with ELGO CAN standard protocol.

The following identifiers are given:

80 (16) + EMAX address = Identifier to request the absolute position

10 (16) + position of decoding switch device (4 byte telegram) = Identifier contains absolute position of the EMAX2 (resolution 0.01 mm)

4Byte acknowledgement telegram

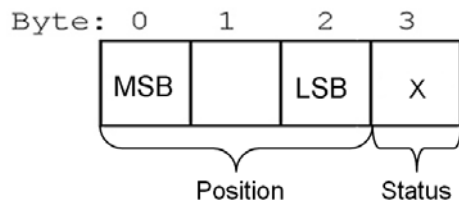

Status:
X = 0 → without error
X = 1 → error magnetic tape

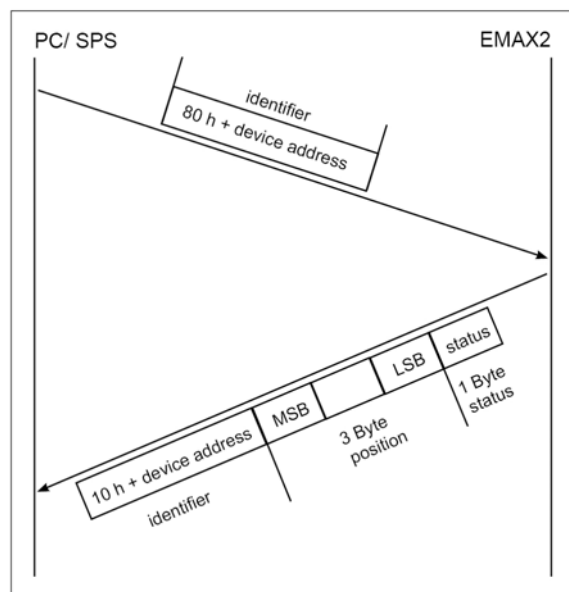

The address can be adjusted in the range of 0₍₁₆₎ to F₍₁₆₎ by a decoding switch, which is located behind a protection cap on the top of the sensor housing

The bit rate can be adjusted by a decoding switch, which is located behind a protection cap on the top of the sensor housing



LED Terminating impedance Address Baud rate

Position	Bit rate
0	500 kBit/s
1	250 kBit/s
2	125 kBit/s

A/B – Incremental Output
(Option HXXX or TXXX)

Optionally two 90° phase shifted square wave channels are available (shaft encoder compatible) with HTL-or TTL-output level (push/pull)

The EMAX resolution (at 4 edge triggering) can have the following amounts:
2.5 μm; 5 μm; 10 μm; 25 μm (for each pulse edge)

Incremental signals

- H2N5** Incremental square wave signals HTL with 2.5 μm resolution
- H005** Incremental square wave signals HTL with 5 μm resolution
- H010** Incremental square wave signals HTL with 10 μm resolution
- H025** Incremental square wave signals HTL with 25 μm resolution
- T2N5** Incremental square wave signals TTL with 2.5 μm resolution
- T005** Incremental square wave signals TTL with 5 μm resolution
- T010** Incremental square wave signals TTL with 10 μm resolution
- T025** Incremental square wave signals TTL with 25 μm resolution

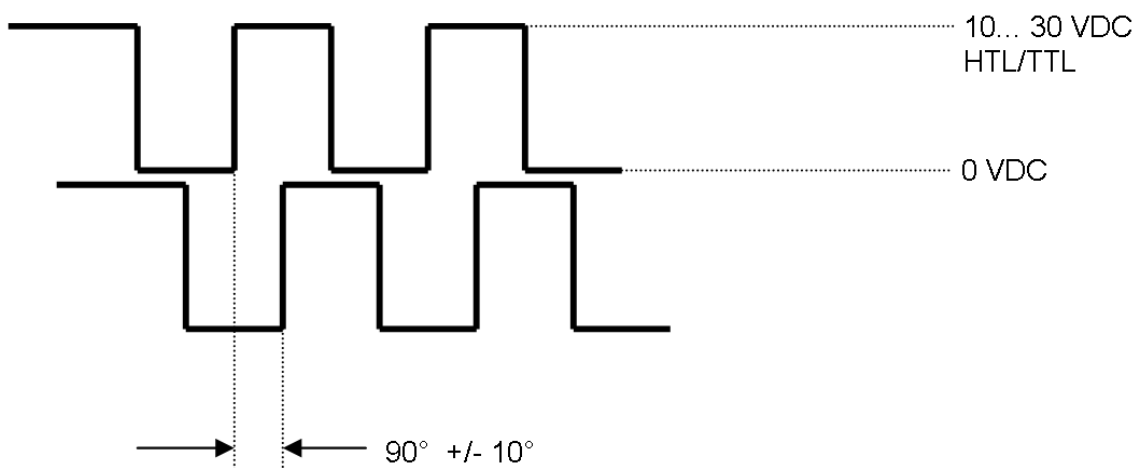

6.3.7 Sine Cosine Incremental Signals (Option SC50)

Optionally Sine Cosine signals with 1 Vpp are available. (push/pull output, short circuit resistant)

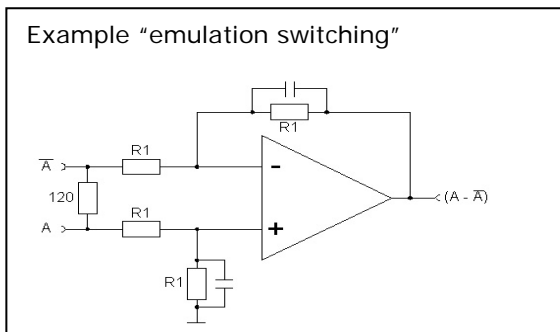
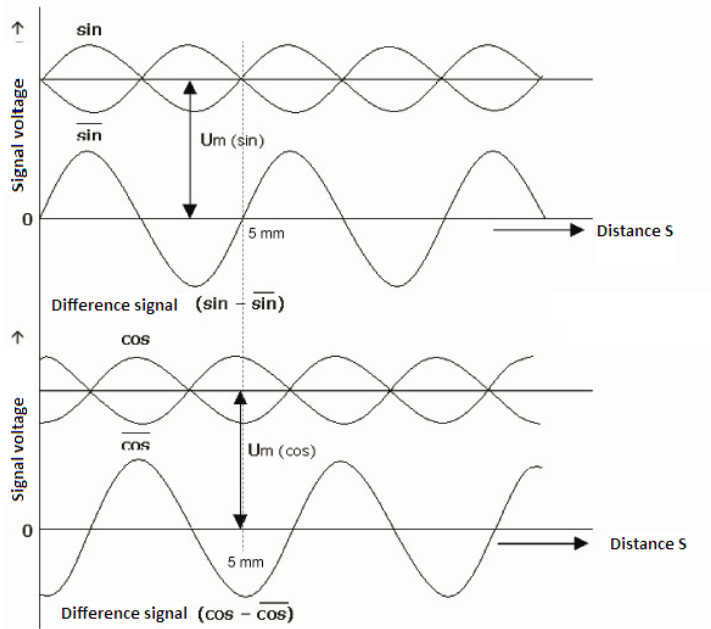

Parameter	Description	min.	typ.	max.	Unit
Medium voltage	Um (sin), Um (cos)	2.4	2.5	2.6	V
Amplitude	$\frac{\overline{\sin - \sin}}{\overline{\cos - \cos}}$	400	500	600	mV
Relationship	$\frac{\overline{(\sin - \sin)}}{\overline{(\cos - \cos)}}$	0.9	1.0	1.1	-
Difference of phase	φ	85	90 +/- 10%	95	° Degree
Distortion factor	K	-	-	3	%

6.3.8 Terminating Impedance

As standard the interfaces CANopen, CAN BASIC ELGO (CN0) and RS422 are supplied with a termination impedance of 120 Ω inside of the interface input. The termination impedance can be deactivated with the S3 switch. The SSI interface is also supplied with an integrated termination impedance. When using option V (encapsulated – IP65) the deactivation of the termination impedance has to be specified by ordering as option A (without termination impedance).



In order to deactivate the termination impedance switch S3 use micro-screwdrivers counter-clockwise.

Switch S3

7 Options

7.1 Magnetic Tape

The magnetic tape consists of 3 components (see picture 5)

- a magnetized flexible rubber tape (pos. 3), which is connected factory made with a
- steel band (pos. 5) and a
- covering band (pos. 1) , which is intended for the protection of the rubber tape.
- For mechanical protection of the magnetic tape the covering band must be stucked on. Additionally it protects the magnetic tape from extreme external magnetic influences.

To reach a complete adhesion between the several materials a special sticky tape is used (pos. 2, pos. 4, pos. 6).

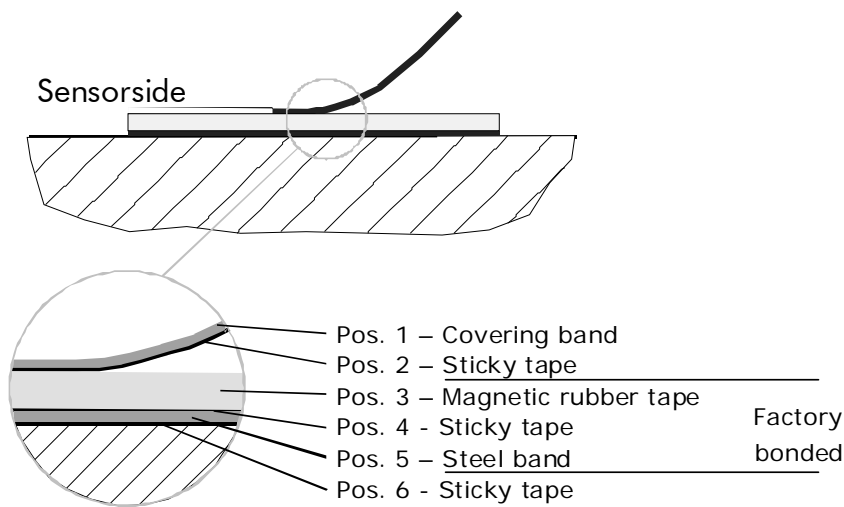

Picture 5: Components of the magnetic tape

7.1.1 Handling

To avoid tension in the magnetic tape, don't tuck or twist it. Avoid also to store or to handle it with the magnetic rubber tape to the inside (min. bend radius 150 mm).

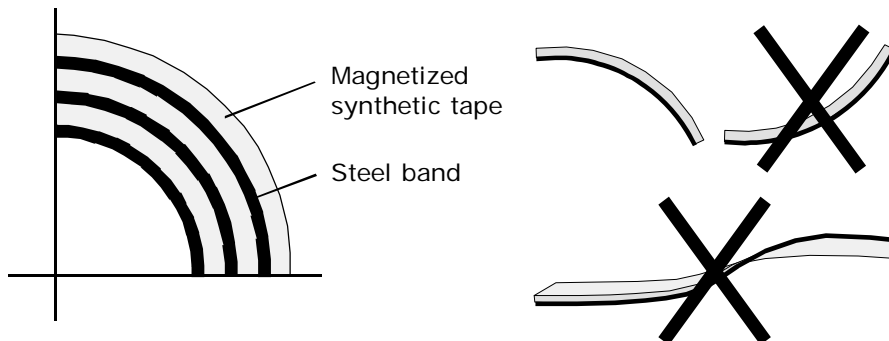

7.1.2 Processing Note for Sticking

The provided sticky tapes stick well on clean, dry and plain surfaces. The worse the pollution at the place of instalment, the better the sticky tapes should be. A surface roughness of $R_a \leq 3.2$ ($R_z \leq 25 / N8$) is recommendable. Typical solvent for cleaning surfaces are a 50/50 - isopropyl-alcohol / water mixture or heptane. The surfaces of materials as copper, brass etc. should be sealed to avoid an oxidation. The stability of the adhesion is directly depending on the contact, which the adhesive develops to the stuck surfaces. A high pressure results in a good surface contact.

The optimal sticking temperature is between + 21 °C and 38 °C.

Avoid colder sticking surfaces than + 10 °C, because in this case the adhesive becomes too hard and perhaps a sufficient immediate adhesion is hardly to achieve. After proper sticking the stability of the connection is ensured, also when the temperature is below zero. The final tackiness of a sticking is from experience reached after approximately 72 hours (at + 21 °C). For sticking use only the provided sticky tape.

7.1.3 Resistance to Chemicals of the Magnetic Tape

Chemicals that show little or no impact after 2-5 years when contacting permanently:

- | | | | |
|--------------------|------------------|---------------|---------------|
| - Formic acid | - Glycerol 93 °C | - Linseed oil | - Soybean oil |
| - cotton oil | - Iso-Octane | - N-Hexane | - Lactic acid |
| - Formaldehyde 40% | - Petroleum | | |

Chemicals that show weak to moderate effects after 1 year when contacting permanently:

- | | | | |
|------------|-------------|-------------------------|------------------------|
| - Acetone | - Petrol | - Acetic acid 20%...30% | - Oleic acid |
| - Kerosene | - Acetylene | - Steam | -(glacial) acetic acid |
| - Seawater | - Ammonia | - isopropyl ether | - Stearic acid 70 °C |

Chemicals that show a strong impact after 1-5 month when contacting permanently:

- | | | | |
|------------------------|--------------------|----------------|-------------------------------|
| - Benzene | - Nitric acid | - Turpentine | - Paint solvents |
| - Carbon tetrachloride | - Trichlorethylene | - Nitrobenzene | - Hydrochloric acid 37%, 93°C |
| - Tetrahydrofuran | - Toluene | - Xylene | - Red fuming Nitric acid |

7.1.4 Sticking and Cutting



NOTE!

When sticking the magnetic tape pay attention to the marks on the magnetic tape and on the sensor head. A faulty installation delivers incorrect values. An already stuck magnetic tape is ruined after removing and can't be used again. Observe also the counting direction of the measuring system.

The magnetic tape and the covering band must be cut to the exact length before sticking.

Magnetic tape length = measuring length + Sensor length

Preferably the magnetic tape should be stuck into a nut or aligned to an edge.

Procedure for sticking: The magnetic tape is already factory bonded with the steel band, in between is a double sided sticky tape. Stick the provided sticky tape onto the carrier side (= steel band).

Now adjust the magnetic tape and stick it onto the surface. The best way to stick the magnetic tape is to do it in two steps. Remove the first half of the adhesive film from the sticky tape and stick it, then do the rest length.

Then stick the sticky tape onto the covering band. It is not important on which side of the covering band the sticky tape is stuck on. Stick the covering band onto the visible brown magnetized synthetic tape.

8 Operation

8.1 Offset

After the installation of the magnetic tape and the measuring system (sensor head), a value is transmit by the interface. Because this value does not conform to the machine zero point, an offset should to be deposited at the controller side.

**NOTE!**

An offset is necessary in each case of a replacement of the EMAX encoder (sensor head) or magnetic tape.

9 Interference

The following chapters describe possible causes for malfunction and the instructions to correct them. If you observe recurring errors you might consider electrical interference suppression measures as described in section 9.2.

If errors cannot be corrected with the following instructions please contact the manufacturer (see last page).

9.1 Security

Basics:

**WARNING!****Risks of injury from improper fault clearances!**

Improper fault clearances can cause serious personal or property damage.

Therefore:

- Fault clearance may only be carried out by qualified and instructed personnel
- Prior to the beginning of work provide sufficient room to assemble the equipment
- Please look for cleanliness at the place of installation
- Loosely around laying parts and tools are sources of accidents

If components have to be replaced:

- Look for correct installation of spare parts
- All mounting elements have to be assembled correctly
- Before resetting please ensure that all covers and protective devices are installed correctly and function properly

9.2 Electrical Interference Suppression

The shield of signal output cable should only be connected one-way to the following electrical device. Signal wires should be installed separately from load power lines and with a safe distance of at least 0.5 m to capacitive and inductive interferences such as contactors, relays, motors, switching power supplies, timed controllers.

If interferences occur in spite of applying all above mentioned measures proceed as follows:

- Add RC elements over contactor coils of AC contactors (for example 0.1 μ F/100 Ω)
- Add recovery diodes over DC inductances
- Add RC elements over each drive phase (in connector box of the drive).
- Do not connect the GND potential with PE (earth potential)!

9.3 Restart after Fault Clearance

After fault clearance:

1. Reset emergency stop switch.
2. Quit disturbance on the control system.
3. Make sure that no person is located in the danger zone.
4. Start operating as explained in chapter "Operation". The shield of the signal output cable should only be connected to one side of the subsequent electronic. The signal output cable must be passed separately from power supply lines and a safety distance of at least 0.5 m has to be kept to inductive and capacitive sources of interference as contactors, relays, motors, power supplies, switch mode regulators etc.

10 Maintenance

The device is maintenance-free.

Examples:

EMAX 0 00 15 01 0 SB0 - - - - -
A **B** **B** **B** **C** **C** **C** **D** **D** **D** **E** **E** **E** **E** **F** **G** **G** **G** **H** **I** **J** **J** **J**

EMAX2 with SSI binary interface, 25 bit and 1.5 m cable

EMAX 0 00 15 01 0 SB0 - - - - - M8 F0 - - - - -
A **B** **B** **B** **C** **C** **C** **D** **D** **D** **E** **E** **E** **E** **F** **G** **G** **G** **H** **I** **J** **J** **J**

EMAX2 with SSI binary interface, 25 bit and 1.5 m cable and M16 cable socket for PNO1

EMAX 0 00 15 01 0 SG0 - - - - - I2N5
A **B** **B** **B** **C** **C** **C** **D** **D** **D** **E** **E** **E** **E** **F** **G** **G** **G** **H** **I** **J** **J** **J**

EMAX2 with SSI Gray interface, 25 bit, 1.5 m cable, TTL square wave signals, 2.5 µm resolution

EMAX 0 00 15 01 0 CN0 12 5k0 - - - - -
A **B** **B** **B** **C** **C** **C** **D** **D** **D** **E** **E** **E** **E** **F** **G** **G** **G** **H** **I** **J** **J** **J**

EMAX2 according to ELGO standard with CAN BASIC ELGO interface, 1.5 m cable, 125 kbit/s and decive address: 0

12 Accessories

Magnetic tape AB20-50-20-2-R-11: Art. No.: 731000110

Technical Data	
Operating temperature	- 20° up to + 85 °C
Stock temperature	- 40° up to + 95 °C
Humidity	max 80 % (non-condensing)
Thermal expansion ΔL	$\Delta L = L \times \alpha \times \Delta \vartheta$ <p><i>(L = measuring length in meter)</i></p> <p><i>($\Delta \vartheta$ = relative temperature change)</i></p> depending on 20° room temperature in °K
Linear expansion coefficient α	16×10^{-6} 1/K
Bending radius	minimal 150 mm
Protection class	IP65
Width	20 mm +/- 0.3 mm
Thickness	1.8 mm +/- 0.1 mm (magnetic tape R)
Max. available lengths	10 m (for option EMAL: 20 m) minimum length 0.2 m
Basic pole length	5 mm
Amount of tracks (absolute)	2
Influence of external magnetic fields	External magnetic fields are not allowed to exceed 64 mT (640 Oe; 52kA/m) at the magnetic tape surface, because it can destroy and damage the magnetic tape code. Magnetic fields > 1 mT at the measuring system have an impact to the system accuracy.
Radius of curvature	min. 150 mm
Magnetic tape length	0.15 m corresponds to the effective measuring length

Guiding wagon FW2080: Art. No.: 734LF0003

Guiding rail FS-1000 (1 m) / FS1500 (1.5 m) / FS-2000 (2 m) for EMAX with FW2080:

- possible rail length: 1 m, 1.5 m or 2 m, measures: length (according to the order) x width (25 mm) x height (6 mm)
- for length > 2m please order several guiding rails in the desired measuring length (up to a maximum of 10m)
example: 5 guiding rails can be strung together, to reach the maximal possible measuring length of 10 meters. The magnetic tape is glue on completely onto the guiding rails which are strung together.
- AB20-50-20-2-R-11 guided option, please order the desired length. The magnetic tape is stuck completely onto the guiding rails which are strung together.

SSI/Profibus converter PNO1:

- Interface converter from SSI to Profibus DP

13 Index

A		M	
Absolute trace	5	Magnetic influences	22
Absolute value	5	Mechanical data	7
B		O	
Basic pole pitch	7	Offset	24
Binary code	16	Ordering	26
C		P	
CAN-Identifier	17	Periodic and random deviation	7
CANopen	17	Pole searcher film	11
Coding	5	Position-request	14
D		Power supply	7
Decoding switch	14	Product features	5
Disposal	4	Protection cap	16
Distortion factor	20	Protective clothing	6
E		R	
Electrical data	7	Recycling	4
External magnetic fields	28	Reference	5
F		Relative humidity	10
Fine interpolation trace	5	S	
Functional principle	5	Safety	6
G		Signal output cable	25
Gray code	16	Sine Cosine signals	20
Guarantee	4	Storage temperature	10
H		T	
Hall sensor	5	Termination impedance	21
I		Transport	10
Incremental signals	19	Transport damages	10
Inductive interferences	25	W	
Installation	11	Warning notices	3

Document History

Rev.	Date	Author	Changes
0	11.04.2011	RL	Document translated

Document- Nr.: 799000616 / Rev.0

Document- Name: EMAX2-000-E_15-11

Subject to change - © 2011

ELGO Electronic GmbH & Co. KG

ELGO Electronic GmbH & Co. KG
Measure - Control - Position

Carl - Benz - Straße 1, D-78239 Rielasingen

Fon: +49 (7731) 9339-0, Fax: +49 (7731) 28803

Internet: www.elgo.de. Mail: info@elgo.de

