

Type P9511

Compact Single Axis Controller

- Integrated Relay Outputs
- Integrated 115 / 230 VAC Power Supply



1. GENERAL	3
2. FEATURES	3
2.1 Two Speed operation	3
2.2 Three Speed Operation	4
2.3 Standard Functions	4
2.3.1 Setting Datum/Go to Datum	4
2.3.2 Encoder Monitoring	5
2.3.3 Quantity Counter	5
2.3.4 Fault Monitoring	5
3. FRONT PANEL	6
3.1 Displays	6
3.2 Function of the Keypad	7
4. CONTROLLER IN OPERATION	8
4.1 Absolute Positioning	8
4.2 Incremental positioning	8
4.3 Counting	8
4.4 Alternative Incremental Operation	8
5. PARAMETER INPUT	9
6. PARAMETER LIST	10
7. DESCRIPTION OF PARAMETERS	11
8. RELAY CONFIGURATIONS	18
9. CONNECTIONS / REAR	21
10. TECHNICAL SPECIFICATIONS	22
11. TYPE DESIGNATION CODE	23
12. LIABILITY EXCLUSION / GUARANTEE	24

1. General

Features:

- 2 or 3 speed positioning
- Absolute and incremental positioning modes
- Operation in Single positioning mode
- Quantity counting with completed output
- Flexible multiplier for Display calibration
- Datum preset routines
- Tool offset compensation in incremental mode
- Incremental error compensation
- Backlash compensation
- Tolerance window blanking
- Encoder and drive failure detection
- maximum Encoder frequency 20 kHz

The unit is suitable for operation with any type of 2 or 3 speed bi-directional drive or any variable speed drive with 1,2 or 4 quadrant of control. The performance and accuracy obtained is dependent on the type of drive chosen. The outputs for stepped speed drives are relays. These outputs can be configured in a number of ways to suit all types of control circuits. Actual position is monitored by incremental Encoder. The power supply unit is integrated. The controller can be used to position machinery to any desired absolute position. Alternatively, the controller can be used to feed material through a process.

2. Features

2.1 Two Speed operation

The positioning is effected using a two speed drive

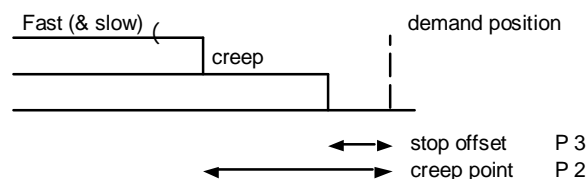

NB: Set $P1 = P2 > P3$

The actual position of the axis is displayed at all times and the demanded position is entered in the bottom display. When START is activated, the controller calculates the difference between the two dimensions and sets the outputs to give the desired direction and speed, to move towards the desired position.

If the distance is greater than the value set in Parameter P1, the drive will first set high speed. As it reaches a distance from it's destination equal to P1, it will drop out the high speed signal and the drive will drop to it's preset creep speed.

2.2 Three Speed Operation

There are a small number of applications where 3 speed operation is desirable. If, for instance, the load inertia is high and the friction is low, the slowdown point must be set at a high value. This means that any required distance to move within this distance, is executed at slow speed only - making machine ponderous. A middle speed can be chosen, to speed up operation.

Positioning is effected as follows:-

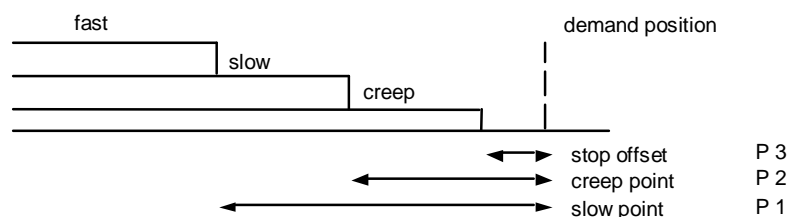

NB: Set $P1 > P2 > P3$

In principle, it operates in exactly the same way as the two speed drive.

2.3 Standard Functions

2.3.1 Setting Datum/Go to Datum

Datum can be set in a variety of ways. The method is selected in Parameter P8/3.

- value = 0: Datum to P7.
Closing input St1/10, transfers the value set in P7 into Actual Value Display.
- value = 1: Setting to Preset.
Closing external input, transfers Demand Display value into Actual Value Display.
- value = 2: Automatic Datuming - direction positive
- value = 3: Automatic Datuming + direction negative
- value = 4: Datum to P7 using Keypad instead of St1/10
The value of P7 is transferred to Actual Display by pressing buttons > followed by F.

Automatic Datuming.

If P8/3 is set to either 2 or 3, activating input St1/10 will cause the drive to rotate forwards (or backwards). When the end limit switch is activated (and maintained), the drive will continue for a time as set in P10. It will then reverse and move at creep speed. When the Encoder marker pulse is sensed, the drive will STOP and value of P7 will be loaded into the Actual Value Display.

2.3.2 Encoder Monitoring

If, after positioning is activated, no Encoder pulses are sensed after a time set in P19 (0.1 to 9.9 s), positioning will be aborted and fault 01 will be displayed.
Setting P19 to 0.0s, disables this feature.

2.3.3 Quantity Counter

The Quantity Counter is programmable. The method of counting is set in Parameter P18/6.

- Value = 1 Automatic Subtracting
The preset value will be decremented automatically at the end of each move.
When count = zero, count complete output is given (if selected in P8/5) and START is inhibited.
- Value = 2 The value entered is memorised. When position window is selected, the counter window sets to zero. The counter is incremented at end of each move. On reaching count = preset, count complete output is given (if selected in P8/5) and START is inhibited.
- Value = 3 Manual Subtracting
As value = 1 but counter decremented by external input.
- Value = 4 Manual Adding
As value = 2 but counter incremented by external input.

2.3.4 Fault Monitoring

When a fault occurs, it's number flashes in Actual Value Display.

Fault Number:	01	=	Encoder
	02	=	End Limit minimum
	03	=	End Limit maximum
	04	=	Actual Position < Min Software Limit (P13) - Manual Demand Position < Min Software Limit (P13) - Single
	05	=	Actual Position > Max Software limit (P14) - Manual Demand Position < Max Software limit (P14) - Single
	06	=	Software fault
	08	=	Position out of tolerance
	*STOP	=	External STOP input activated or wire break

The fault message is cleared by pressing any button.

* NB: External STOP input must be linked out before system can operate.
Therefore, if external n/c pushbutton is not fitted, then insert a wire link.

STOP also flashes if STOP on front of panel is activated in middle of move.

3. Front Panel

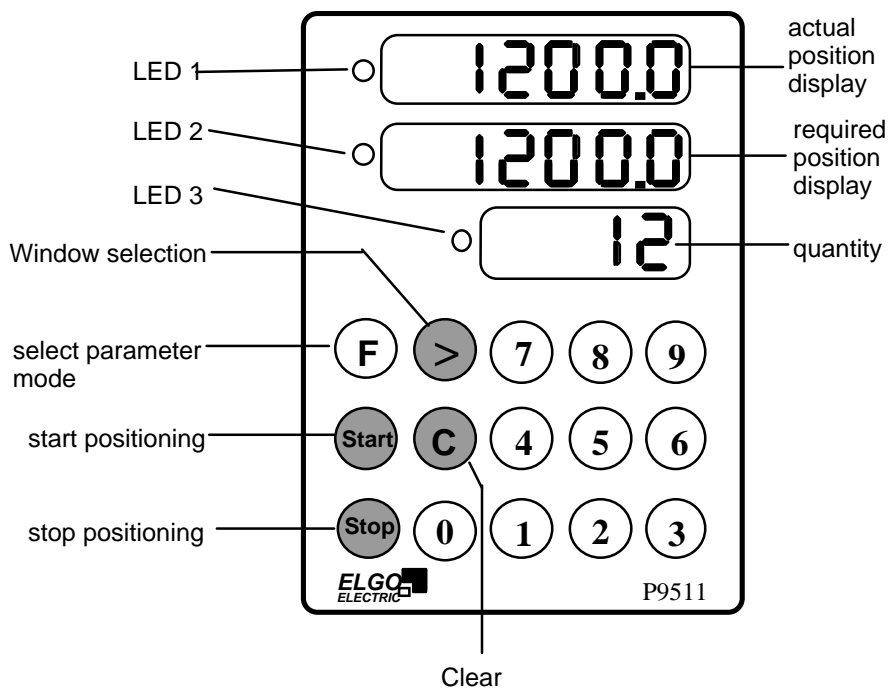

3.1 Displays

Actual Position	Shows the actual position of the Axis
Demand Position	Here you can enter the required position
Quantity	Shows how many pieces are left to be cut; (or) How many incremental moves yet to be complete
LED1	Negative sign symbol Also illuminates when Parameter entry mode selected
LED2	Illuminates when Demand Position or Parameter input can be entered
LED3	Illuminates when Quantity demand can be entered

3.2 Function of the Keypad

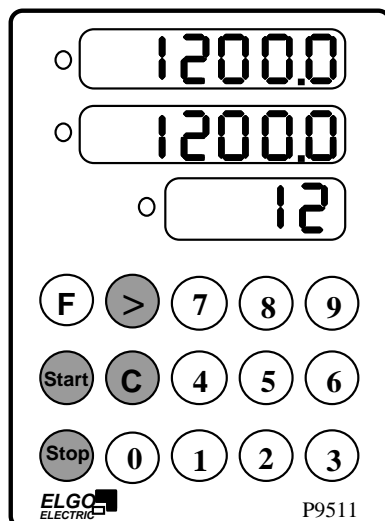

- F** Depressing this button for 3 sec will switch the controller from Operation to Parameter setting mode.
- START** START positioning action.
START is inactive in Parameter setting mode and manual mode.
- STOP** STOP positioning action.
In programming mode, sets end-of-programme.
- >** Cursor Button:
In Run mode selects between Demand window or Quantity window
In Parameter setting mode selects alternately and sequentially
 - *Parameter Number*
 - *Parameter Value*
- C** Clears selected function or parameter value.
Also clears Demand Value in Single run mode
- 0-9** Numerical Keypad for entry of values at all times.

4. Controller in Operation

4.1 Absolute Positioning

- Select Demand window using > button
- Clear existing value using C button
- Enter new Demand position using Numerical Keypad
- Select Quantity window using > button
- Clear existing value using C button
- Enter new Quantity required using Numerical Keypad
- Select Demand window again using > button
- Press START.
- The axis will move to the new position.

4.2 Incremental positioning

If Incremental mode is selected in P18/3, the Demand Window will be the distance to move, rather than the absolute required position. The Actual Position Window always displays the absolute position of the axis.

4.3 Counting

In absolute setting mode, it is usual for an external input to decrement the counter (eg the number of sheets cut at that size).

In incremental setting mode, the counter can be decremented automatically on completion of each move or by means of external input, as desired.

4.4 Alternative Incremental Operation

The parameter P18/3 relates to the „normal“ START input, P82 = 4. Alternative START inputs can be selected in P80-84.

Value = 10

Despite setting of P18/3 = 0 ie „Positioning Absolute“, activating this input will assume the Demand is incremental +ve. Actual value display remains absolute.

Value = 11

As value = 10, but operation in incremental -ve.

Value = 12

This input resets the Actual value display to zero on each START and movement is incremental without limit. This feature should be used for incremental Roll feed applications and similar.

5. Parameter input

Press F for 3 seconds. LED1 illuminates

Actual Value Window now shows Parameter Address

The Parameter 98 (Security Parameter) is initially displayed, if Parameters are locked.

Parameter values cannot be changed until a Security Code is entered.

Press >	Demand Window shows all zeros
Enter	250565 (the Security Code)
Press >	Actual Value Window now shows 01 (= Parameter 1)
Press 0-9	→ to enter the desired Parameter number
Press >	The value of that Parameter is now displayed in Demand Window LED 2 is also illuminated
Press C	→ to clear existing value
Press 0 - 9	→ to enter new Parameter value
Press >	The new value is stored The next Parameter number is displayed in Actual Window
Press >	The value of the new Parameter is displayed in Demand Window
etc.	
Use >	→ To scroll through parameter list → To exit Parameter setting mode, Press F → The Actual Position will again be displayed.

The Parameters can once again be accessed, by pressing F for 3 s.

The Parameters can be locked away, by either

Powering down

Selecting Parameter 98, press >, press F

6. Parameter List

Par.	Function	Resolution	Default Customer
01	Slow speed distance	0.1 mm	10.0*
02	Creep speed distance	0.1 mm	5.0*
03	STOP offset	0.1 mm	0.0
04	Backlash compensation	0.1 mm	1.0
05	Retract distance	0.1 mm	0.0
06	Tool width	0.1 mm	0.0
07	Datum value	0.1 mm	0.0
08	System Param 1	--	000000
09	Position reached pulse	0.1 s	1.0 (0=held)
10	Backlash dwell time	0.1 s	1.0
11	Quantity reached pulse	0.1 s	1.0 (0=held)
12	Tolerance window	0.1 mm	0.0
13	Min software limit	0.1 mm	0.0
14	Max software limit	0.1 mm	100000
15	Encoder pulse multiplication	0.00001 to 9.99999	1.00000
17	Display brightness	00 to 99	50
18	System Param 2	--	000000
19	Encoder pulse monitor time	0.1 s	0.0
20	Decimal point	0,1,2	1
27	Offset positive	0,1	0
28	Offset negative	0,1	0
56	Encoder edge multiplier	1,2,4	1
70	Time delay for relays 2,3,4 when P08/5 is set to 9	0.1 s	0.0
71	Time for Re-Try	0.1 s	1.0
80	Input St3/13 definition	1-12	000002
81	Input St3/12 definition	2-12	000003
82	Input St3/11 definition	2-12	000004
83	Input St3/10 definition	2-12	000005
84	Input St3/9 definition	2-12	000006
86	Deadman interlock - ve	0.1 mm	0.0
87	Deadman interlock + ve	0.1 mm	99999.9
88	System Param 3	--	000000
98	Security code	250565	
99	Service		

* Logical sequence values such as these must always be present, regardless whether 3, 2 or 1 speed drive is used. P1 > P2 > P3 for 3 speed drive P1 = P2 > P3 for 2 speed or 1 speed drive

7. Description of Parameters

P01 Slow speed distance

Distance at which the controller switches from high speed to slow speed. The output high speed will be switched off.

P02 Creep speed distance

Distance to demand position at which the controller switches from slow to creep speed.

P03 STOP offset distance

The overrun distance can be programmed to compensate for the distance from the switch-off point of the motor, to standstill. For exact positioning, the correction distance should be very small (0.0 to 0.5 mm). Therefore the mechanical friction should be steady and the creep speed should be very slow.

P04 Backlash overrun

To correct for screw or pinion backlash, the Demand position should be approached from one direction only. In positive direction therefore, the Demand position will be overrun by the value of P4 and driven back at slow speed, after a time delay of P10, to the Demand position.

P05 Retract distance

There are different modes available in the P9511, selectable by Parameter P18/2.

If P18/2 = 0 Retract Position = Actual + P5

If P18/2 = 1 Retract Position = Value of P5

Whilst the input St1/11 is held on, the Slide will move to the "Retract" position. On release of input, slide will return to the original position.

If P18/2 = 2 Retract Position = Value of P5

When input St1/11 is activated, the slide moves to position as set in P5 and will not return to original position on release of input.

If P18/2 = 3 Retract Position = Actual + P5

If P18/2 = 4 Retract Position = Actual -P5

P06 Tool offset compensation

When moving in incremental, it is often the case that the subsequent function is a cut that removes part of the material. Thus to cut accurate preset lengths, it is necessary to move the demanded distance plus the "Tool Offset".

P07 Datum

The Datum value is stored in this Parameter. The value is used in different ways, in accordance with setting of P8/3

P08 Systemparameter 1

This Parameter sets the basic operating functions of the unit.



Backlash

- 0 = no backlash compensation
- 1 = negative backlash comp
- 2 = positive backlash comp
- 3 = retry with negative backlash
- 4 = retry with positive backlash

Output Relay Config

- 0 = 3 speed operation
- 1 = Forward + Backwards
- 2 = Run + Reverse
- 3 = Independent outputs
- 4 = Fast only in reverse
- 5 = 3 speed Binary coded
- 6 = 3 speed binary + Pos reached
- 7 = 3 speed binary + Q reached
- 8 = 1 speed + Pos + Q reached
- 9 = Relay 1 set immediately, 2,3&4 delayed by P70

Option

Datum

- 0 = Datum to P7
- 1 = Datum to Demand
- 2 = Datum sequence +ve
- 3 = Datum sequence -ve
- 4 = Datum to P7 by keypad

Option

Type of positioning

- 0 = Fast/slow/STOP

P09 Time position reached

At the end of each move, the controller gives an output, to signal "in position". The length of this pulse is set in P9. Setting 0.0 gives a maintained output.

P10 Backlash dwell time

When the machine STOPS at the end of the overrun, it is usually desirable to have a short delay. The time is set in this Parameter.

P11 Pulse "Quantity complete"

When the quantity counter goes from 1 to 0, a pulse output is given. The length of this pulse is set in P11. Setting 0.0 gives a maintained output.

P12 Tolerance window

It is possible to enter a value in Parameter P12 which represents an acceptable tolerance e.g. 0.1 mm. When the Actual Position is within the Tolerance window, the actual position displayed is made equal to the Demand position. The actual error is not lost, as the controller knows the true position.

P13/P14 Min/Max software limits

		Fault Message
Demand < Limit P13	=	04
Demand > Limit P14	=	05

Immediately after START signal, the controller checks the software limits. If the Demand position is greater or smaller than the corresponding limit, the controller will STOP and show the error message on the display. The backlash distance in P4 is considered at the check of the Max software limit, if the backlash distance is activated in P8/6.

P15 Pulse multiplication

In this Parameter can be entered a factor (0.00001 to 9.99999). The incoming pulses will be multiplied by this factor, to manipulate the display in required dimensions. If no multiplication is required, this Parameter must be set to 1.00000.

P17 Display brightness

With the setting of this Parameter, the brightness of the displays can be altered. 0.0 = dark, 9.9 = max brightness.

P18 Systemparameter 2

This Parameter also sets the functions of the controller.

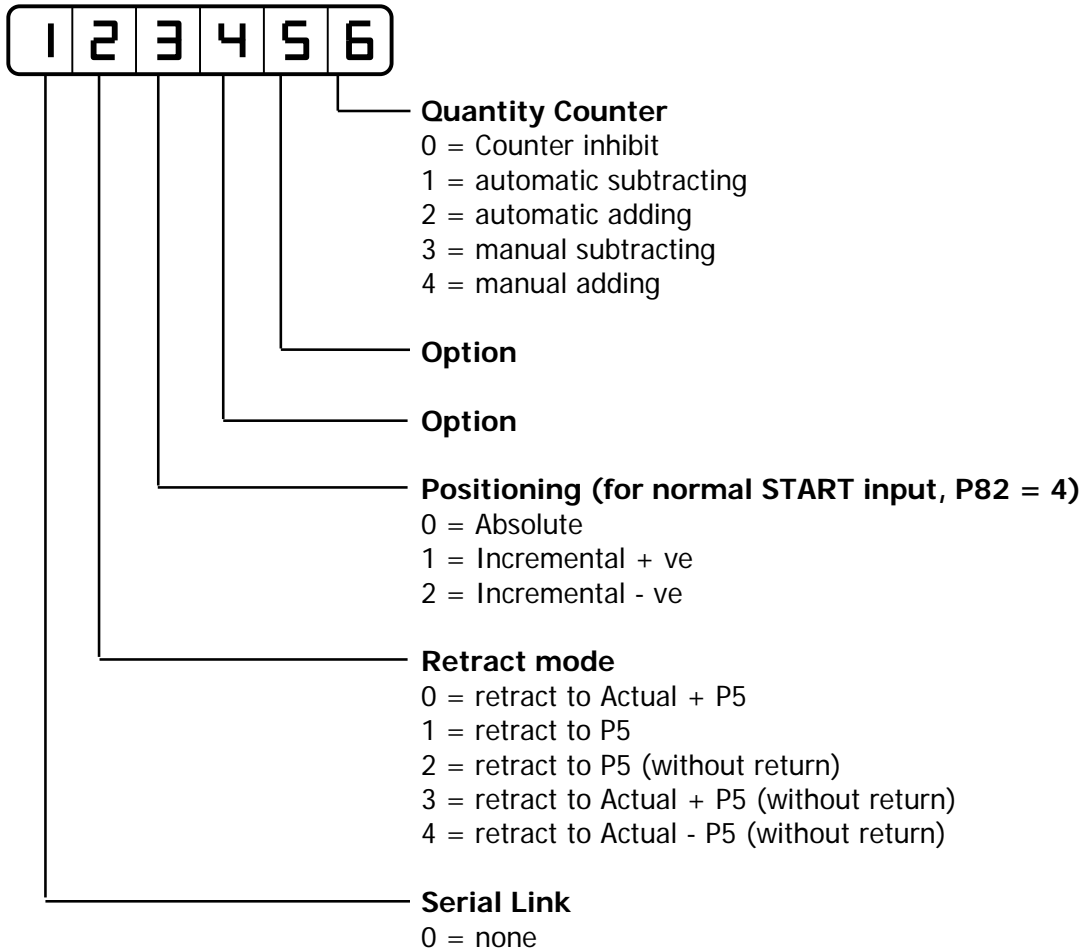

P19 Encoder monitoring

If after positioning is initiated, no Encoder pulses are sensed after a time set in P19, positioning will be aborted and Fault 01 will be displayed. Setting P19 to 0.0, disables Encoder pulse monitoring.

P20 Decimal point

The decimal point is placed in a fixed position and is optical only. It does not change the resolution of the system.

Settings: 0 = no decimal point / 1 = 0.0 / 2 = 0.00 / 3 = 0.000

P27 Offset positive

The value, stored in this parameter is to added to the actual position at the activation of an input. (The input is selected by code 13)

P28 Offset negative

The value, stored in this parameter is subtracted from the actual position at the activation of an input. (The input is selected by code 14).

P56 Encoder edge multiplication

Settings: **1** = x 1 / **2** = x 2 / **4** = x 4

P70 Relay delay

The operation of relays 2, 3, and 4 can be delayed, if required.

The time delay is set in this Parameter. This time is only active when P8/5 is set to 9.

P71 Automatic retry and STOP offset calculation

When P8/6 = 3 or 4, automatic retry of position is made, if the position reached falls outside the tolerance window. In such a case, after a time set in P71 (0.1 to 99999.9 sec), the STOP offset Parameter P3 is recalculated and stored to equal:

„old STOP offset + error between Demand and Actual“

The drive automatically restarts and repositions with this new value of offset. If it again STOPS outside tolerance window, then it does not retry again, but instead brings up error 8.

Tolerance window must not be set to zero - best at least 0.2 mm.

P80-84 Configuration of inputs

The input functions can be selected in these Parameters. The Parameters select which function will be allocated to each input.

Allocation: Parameter

80 > Pin13	(Default value = 2)
81 > Pin12	(Default value = 3)
82 > Pin11	(Default value = 4)
83 > Pin10	(Default value = 5)
84 > Pin9	(Default value = 6)

The functions are defined as:

Marker pulse	value = 1 (only settable at Pin13)
START	2
STOP	3
Retract	4
Datum	5
Quantity counter	6
Endlimit -ve	8
Endlimit +ve	9
START incremental + ve	10
START incremental - ve	11
START to zero	12
Offset positive	13
Offset negative	14

NB: The STOP input is secured against cablebreak. It must be active for positioning to take place.

P86 Deadman's interlock direction - ve

Only active when P88/5 = 2

Front START must be inhibited by setting P88/3 = 1.

The external START input in backwards direction will operate as START/STOP, below this value.

P87 Deadman's interlock direction + ve

Only active when P88/5 = 2

Front START must be inhibited by setting P88/3 = 1

The external START input in forwards direction will operate as START/STOP, above this value.

P88 Systemparameter 3

This Parameter sets further basic functions of the controller.

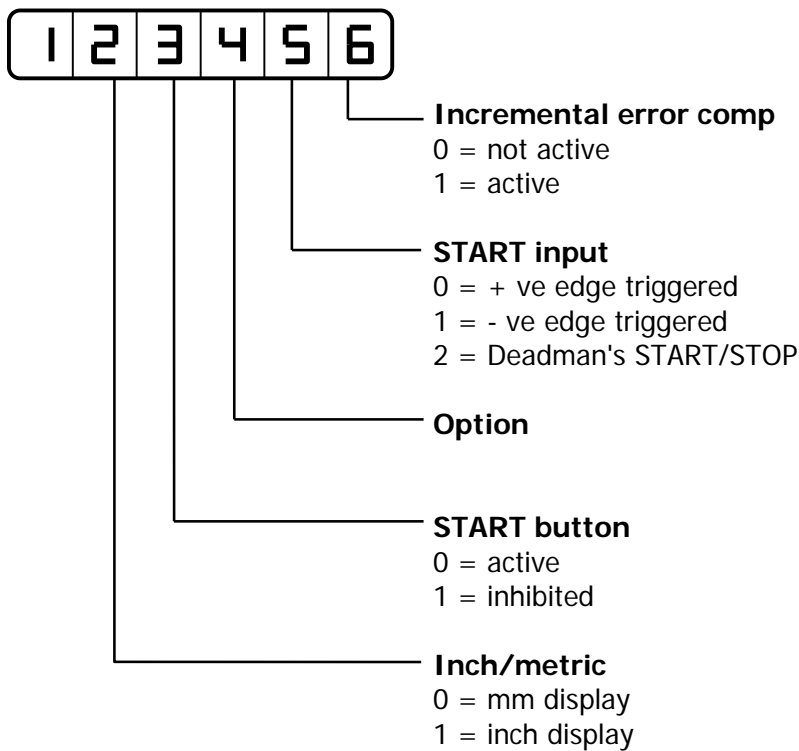

P98 Security code

Enter 250565 to unlock and change Parameters

P99 Service Parameter

Only active when P98 is unlocked.

P99 must be reselected after activating any select button as shown below.

Button 0 - Pressing this button loads default values into all Parameters

Button 6 - Selects display of hardware inputs and outputs, for testing purposes

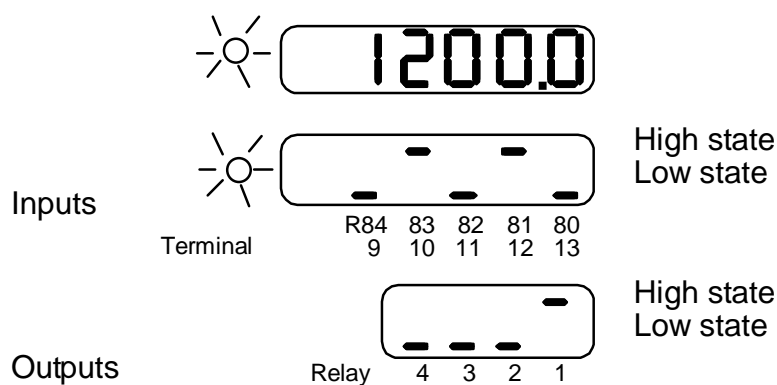

To test outputs:

1. Enter demand value
2. Press START .The specific inputs / outputs will change state in displays)
3. On position reached, new demand value can be entered

To test inputs:

Activate external input and note change in display

End test operation with button „C„

Button 7 - gives details of the software inside unit

e.g.:

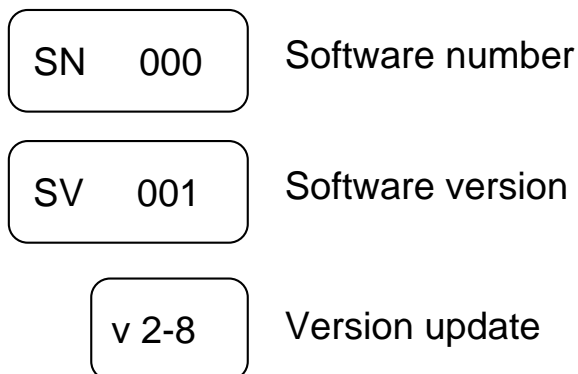

8. Relay Configurations

These depend on setting of Parameter P8/5

Value = 0 3 speed operation (Elgo standard default)
3 speed selected by relays 1,2&3 Relay 4 sets direction reverse

Relay	1	2	3	4
Creep forwards	x			
Slow forwards	x	x		
Fast forwards	x	x	x	
Creep reverse	x			x
Slow reverse	x	x		x
Fast reverse	x	x	x	x

R1 = Run. R2 & R3 are Slow & Fast combined with Run. If used with 2 speed, you can use either R1 or R2 for Fast. Can also be used with single speed.

Value = 1 2 speed operation Independent outputs forward and reverse
Independent outputs fast and slow

Relay	1	2	3	4
Creep forwards	x	x		
Slow forwards				
Fast forwards	x		x	
Creep reverse		x		x
Slow reverse				
Fast reverse			x	x

R1 = Run For, R4 = Run Rev. R2 & R3 independent

Value = 2 2 speed operation Speed set by Relays 2 & 3 Direction set by Relay 4

Relay	1	2	3	4
Creep forwards	x	x		
Slow forwards				
Fast forwards	x		x	
Creep reverse	x	x		x
Slow reverse				
Fast reverse	x		x	x

R1 = Positioning (Drive inhibit or Brake) R2 & R3 independent

Value = 3 2 speed operation Independent outputs for direction and speed

Relay	1	2	3	4
Creep forwards	x			
Slow forwards				
Fast forwards		X		
Creep reverse			x	
Slow reverse				
Fast reverse				X

Value = 4 3 speed operation Forwards - 3 relays set speeds
Reverse - always fast Output 4 = reverse

Relay	1	2	3	4
Creep forwards	X			
Slow forwards	X	X		
Fast forwards	X	X	X	
Creep reverse	X	X	X	X
Slow reverse	X	X	X	X
Fast reverse	X	X	X	X

Value = 5 3 speed operation Binary coded

Relay	1	2	3	4
Creep forwards	X			
Slow forwards		X		
Fast forwards	X	X		
Creep reverse	X		X	
Slow reverse		X	X	
Fast reverse	X	X	X	

Value = 6 3 speed operation (binary coded) with "Position Reached" output "P"

Relay	1	2	3	4
Creep forwards	X		P	
Slow forwards		X	P	
Fast forwards	X	X	P	
Creep reverse	X		P	X
Slow reverse		X	P	X
Fast reverse	X	X	P	X

For 2 speed (P1 = P2): R1 = Run, R2 = Fast. Can also be used with 1 speed.

Value = 7 3 speed operation (binary coded) with "Quantity Reached" output "Q"

Relay	1	2	3	4
Creep forwards	X		S	
Slow forwards		X	S	
Fast forwards	X	X	S	
Creep reverse	X		S	X
Slow reverse		X	S	X
Fast reverse	X	X	S	X

Value = 8 1 speed operation with "Position Reached" output "P"
with "Quantity Reached" output "Q"

Relay	1	2	3	4
Creep forwards	X		S	P
Slow forwards	X		S	P
Fast forwards	X		S	P
Creep reverse		X	S	P
Slow reverse		X	S	P
Fast reverse		X	S	P

Value = 9 3 speed operation Speed set by Relays 1-3 Output 4 sets reverse
Relay 1 is set immediately Relays 2, 3 & 4 are set after delay P70

Relay	1	2	3	4
Creep forwards	X			
Slow forwards	X	X		
Fast forwards	X	X	X	
Creep reverse	X			X
Slow reverse	X	X		X
Fast reverse	X	X	X	X

9. Connections / Rear

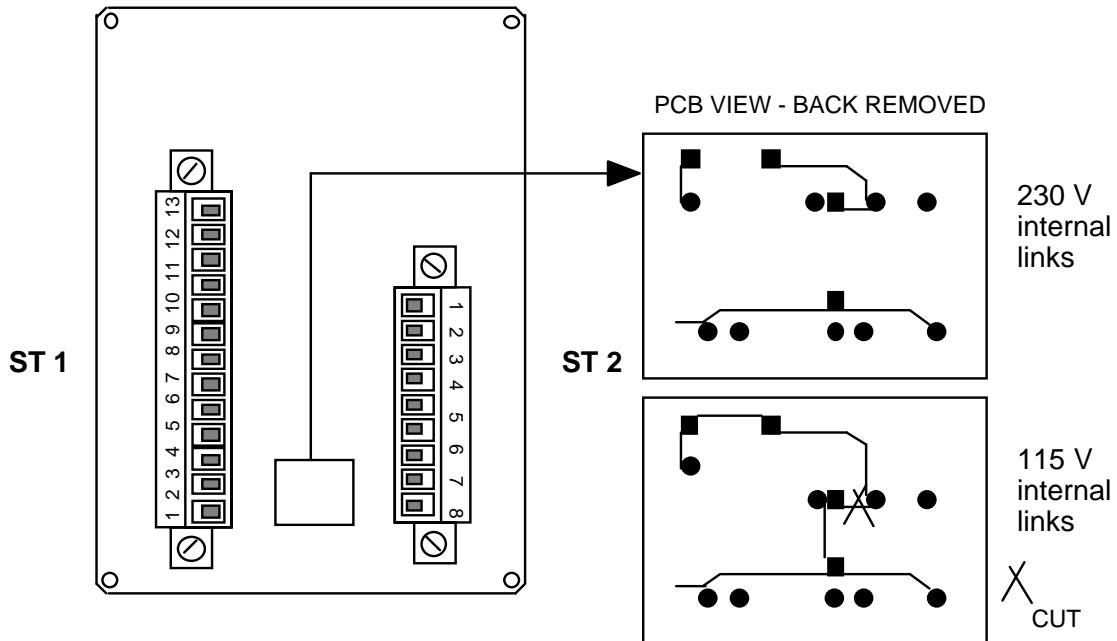

Connector ST1 13 pole Inputs

Pin	Function (Defaults)
13	START
12	STOP
11	Retract
10	Datum
9	Quantity
8	+24v
7	Channel A
6	Channel B
5	Encoder +24v supply
4	Encoder 0v supply
3	Earth & Screens
2	24 VDC, 230/115v ac supply*
1	0 V supply*

Connector ST2 8 pole Output relays

Pin	Function (Defaults)
1	Relay 1 (Creep = Run)
2	
3	Relay 2 (Slow)
4	
5	Relay 3 (Fast)
6	
7	Relay 4 (Rev)
8	
n/o	contact

Pull Terminals 9 – 13 up to 24V (Terminal 8), to activate.

*Set by internal links (see above).

10. Technical specifications

Power supply	24 VDC, 230/115 v ac 50/60 Hz (selected by internal links)
Consumption	450 mA
Encoder supply	24 VDC, max load 130 mA
Counting frequency	20 kHz, higher on request
Input signals	PNP standard min. pulse time 300 ms (NPN as option "EN")
Outputs	potential free shutter relays (250 V / 1 A)
Memory	NOV-Ram, 10 years
Connectors	RIA
Display	Low power LED, 7 segment, 8 mm high
Hardware	16 bit Microprocessor with 32 Kbytes E-Prom and 16 Kbytes RAM
System accuracy	+/- 1 bit
Enclosure	Black metal, for fitting into control panels
Dimensions in	W x H x D = 72 x 96 x 90 (+ 30 mm for connectors)
Cut-out in mm	67 x 93 mm
Operation temperature	0... 45 ° C

11. Type designation code

P 95 1 1 - 000 - 230 - 0 - XXXXXXX

P = Position Controller

Series
P9511 without program memory

Programme Memory
1 = none

Number of Axes

Construction
000 = standard
001 = 1st special version
etc.

Supply voltage

024 = 24 VDC
115 = 115 VAC
230 = 230 VAC

Encoder input

0 = A / B - 24 V / 24 V (20 KHz, PNP)
1 = A / B / Z - 24 V / 24 V (20 KHz, PNP)
M* = A / B - High-speed counting for EMIX and MIX System
N* = A / B / Z - High-speed counting for EMIX and MIX System with index signal

Special Features

EN = input NPN

*under construction

12. Liability exclusion / Guarantee

We have checked the contents of this instruction manual carefully, to the best of our knowledge and belief for conformity with the described hardware and software. Nevertheless errors, mistakes or deviations can not be excluded, therefore we do not guarantee complete conformity. Necessary corrections will be included in the subsequent editions. We appreciate your ideas and improvement suggestions very much. Reprint, duplication and translation, even in extracts, are only allowed with a written authorization by the company ELGO Electric GmbH. We constantly strive for improving our products, therefore we keep all rights reserved for any technical modifications without any notice.

ELGO Electric does not assume any liability for possible errors or mistakes.

The guarantee period is one calendar year from the date of delivery and includes the delivered unit with all components. ELGO Electric GmbH will at its option replace or repair without charge defects at the unit or the included parts, verifiable caused by faulty manufacturing and/or material in spite of proper handling and compliance to the instruction manual.

Damages verifiably not caused by ELGO Electric GmbH and due to improper handling are excluded from any guarantee e.g. by applying faulty voltage, diffusion of liquid into the interior of the engine, using force, scratching the surface, chemical influences etc.!

Subject to modifications - © ELGO Electric GmbH 2006

ELGO - Electric - GmbH
Measure - Control - Position
Carl - Benz - Straße 1, D-78239 Rielasingen
phone.: 0049-7731/93 39 - 0, Fax: 2 88 03
Internet: www.elgo.de, Mail: info@elgo.de

The logo for ELGO, featuring a dark grey square with a white L-shaped cutout, and a smaller orange square positioned below the white cutout.