

Single-Phase Solid State Relay

HSR-2D/2A

INSTRUCTION MANUAL

We appreciate you for purchasing HanYoung NUX Co.,Ltd product. Before using the product you have purchased, check to make sure that it is exactly what you ordered. Then, please use it following the instructions below.

MAIN PRODUCTS

- DIGITAL : Temperature Controller, Counter, Timer, Speedmeter, Tachometer, Panel Meter, Recorder
- SENSOR : Proximity Switch/Photo Electric Sensor, Rotary Encoder, Optical Fiber Sensor, Pressure Sensor
- ANALOG : Timer, Temperature Controller

HEAD OFFICE

1381-3, Juan-Dong, Nam-Gu Incheon, Korea
 TEL: (82-32)876-4697 FAX: (82-32)876-4696

■ Safety information

Before you use, read safety precautions carefully, and use this product properly. The precautions described in this manual contains important contents related with safety; therefore, please follow the instructions accordingly. The precautions are composed of DANGER, WARNING and CAUTION.

DANGER

Do not touch or contact the input/output terminals because they may cause electric shock.

WARNING

1. Before you use, read safety precautions carefully, and use this product properly.
2. Do not touch or contact the input/output terminals because they may cause electric shock.
3. The user must install the external safety equipment when there are possible defect of this product or serious accidents.
4. To prevent deflection or malfunction of this product, supply proper power voltage in accordance with the rating.
5. To prevent electric shock or devise malfunction of this product, do not supply the power until the wiring is completed.
6. Reassemble this product while the power is off. Otherwise, it may cause malfunction or electric shock.
7. If the user use the product with methods other than specified by the manufacturer, there may be bodily injuries or property damages.
8. Due to the danger of electric shock, use this product installed onto a panel while an electric current is applied.

CAUTION

1. Before using the product you have purchased, check to make sure that it is exactly what you ordered.
2. Do not use this product at any place with corrosive (especially noxious gas or ammonia) or flammable gas.
3. Do not use this product at any place with liquid, oil, medical substances, dust, salt or iron contents.
4. Do not use this product at any place with excessive induction trouble, static electricity or magnetic noise.
5. Do not use this product at any place with possible thermal accumulation due to direct sunlight or heat radiation.
6. When the product gets wet, the inspection is essential because there is danger of an electric leakage or fire.
7. Do not connect anything to the unused terminals.
8. For DC types, connect wires at the correct position after checking polarity of terminal.
9. The rated heat sink must be used; otherwise, the product may be destroyed.
10. When product is disposed, treat as a industrial waste.

■ Ordering Information

MODEL	Suffix code	Description
HSR	2 A 50 2 Z	
Control Phase	2	Single Phase
	3	Three Phase
Input control voltage	D	4 - 32 V d.c
	A	90 - 264 V a.c
Rated load current	50	50 A
	70	70 A
Rated load voltage	2	90 - 264 V a.c
	4	90 - 480 V a.c
Operation method (Switching Mode)	Z	Zero Cross Switching
	R	Random Switching
Heat Sink	-	Without Heat Sink
	-T	With Heat Sink

■ Rated Specifications

■ Direct Current(DC) Input Type

Model	HSR-2D502Z	HSR-2D702Z	HSR-2D504Z	HSR-2D704Z	
	HSR-2D502R	HSR-2D702R	HSR-2D504R	HSR-2D704R	
INPUT	Rated Voltage				5 - 24 V d.c
	Operating Voltage Range				4 - 32 V d.c
	Impedance				Max. 4 kΩ
	Operation Voltage				Min. 3 V d.c
	Reset Voltage				Max. 1.5 V d.c
OUTPUT	Input Current				Constant Current method : 10 mA (±3)
	Rated Load Voltage		100 - 240 V a.c		100 - 440 V a.c
	Operating Voltage Range		90 - 264 V a.c		90 - 480 V a.c
	Peak Voltage (non-repetition)		800 V		1200 V
	Rated Load Current		50 A	70 A	50 A 70 A
	Frequency				25 - 65 Hz
	Surge Current				580 A
	Leakage Current				Max. 20 mA
	On State Voltage drop				1.8 V (Max. R.M.S)
	Min. Operation Current				0.5 A
Zero Cross Function		O	X	O	X
Response Time		1/2Cycle+ 1 ms Max.	Max. 1 ms	1/2Cycle+ 1 ms Max.	Max. 1 ms
Insulating Resistance					500 V d.c, 100 kΩ (Input/Output and between Case)
Dielectric Strength					2500 V a.c (For one min. in 60 Hz)
Vibration					10 - 55Hz, Double amplitude: 1.5mm, Each X,Y,X axis for 2 hours
Shock					1000 %g (about 100 G), Each X · Y · Z axis for 3 times
Storage Temperature					-30 - 90 °C
Ambient Temperature					-20 - 80 °C
Ambient Humidity					45 - 85 % R.H.
Weight					About 130 g

Notes : The weight does not include package box.

■ Alternating Current(AC) Input Type

Model	HSR-2A502Z	HSR-2A702Z	HSR-2A504Z	HSR-2A704Z	
	HSR-2A502R	HSR-2A702R	HSR-2A504R	HSR-2A704R	
INPUT	Rated Voltage				100 - 240 V a.c
	Operating Voltage Range				90 - 264 V a.c
	Impedance				Max. 40 kΩ
	Operation Voltage				Min. 75 V a.c
	Reset Voltage				Max. 40 V a.c
OUTPUT	Input Current				240 V a.c / 9 mA (±4)
	Rated Load Voltage		100 - 240 V a.c		100 - 440 V a.c
	Operating Voltage Range		90 - 264 V a.c		90 - 480 V a.c
	Peak Voltage (non-repetition)		800 V		1200 V
	Rated Load Current		50 A	70 A	50 A 70 A
	Frequency				25 - 65 Hz
	Surge Current				580 A
	Leakage Current				Max. 20 mA
	On State Voltage drop				1.8 V (Max. R.M.S)
	Minimum Operation Current				0.5 A
Zero Cross Function		O	X	O	X
Response Time		1/2Cycle+ 1 ms Max.	Max. 1 ms	1/2Cycle+ 1 ms Max.	Max. 1 ms
Insulating Resistance					500 V d.c, 100 kΩ (Input/Output and between Case)
Dielectric strength					2500 V a.c (For one min. in 60 Hz)
Vibration					10-55Hz, Double amplitude: 1.5mm, Each X,Y,X axis for 2 hours
Shock					1000 %g (about 100 G), Each X · Y · Z axis for 3 times
Storage Temperature					-30 - 90 °C
Ambient Temperature					-20 - 80 °C
Ambient Humidity					45 - 85 % R.H.
Weight					About 130 g

Notes : The weight does not include package box.

External Dimension

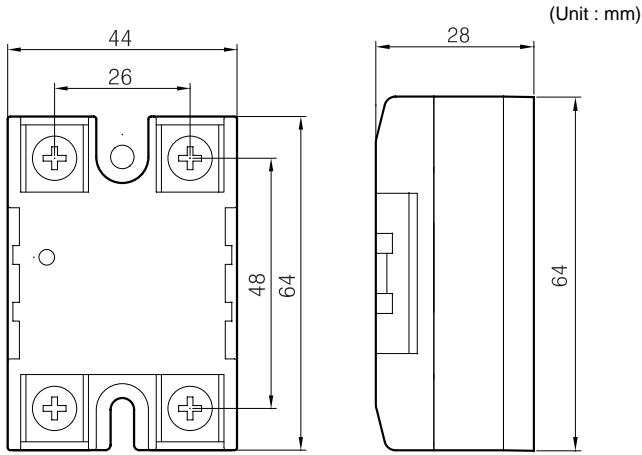

Circuit

DC Input Type

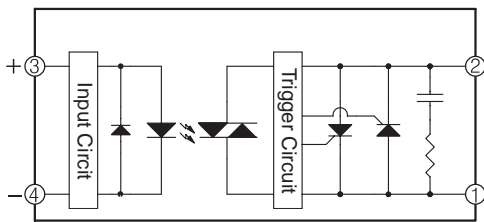

AC Input Type

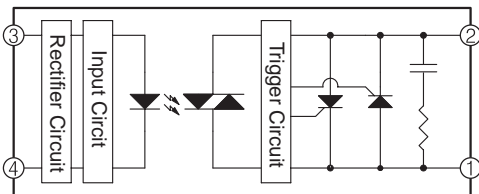

Application Circuit

DC Input Type

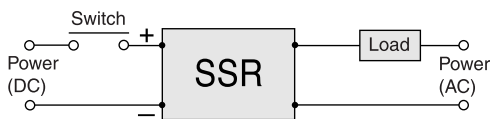

AC Input Type

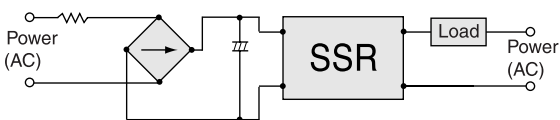

Load Current Characteristics

Input Voltage / Current Characteristics

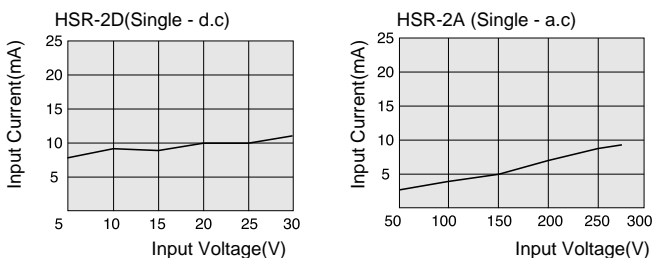

Load Current Characteristics

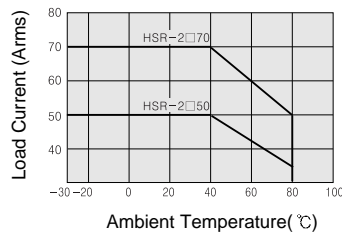

Surge Current Characteristics

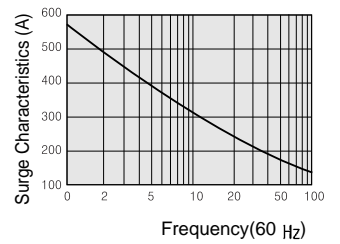

Heat Sink

(Unit : mm)

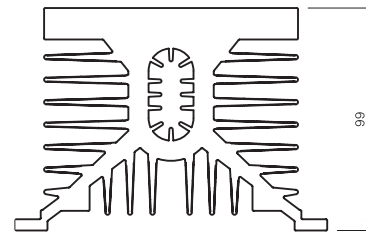
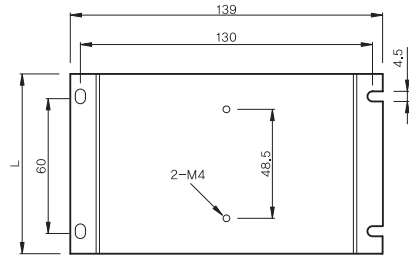

Model	Applicable Model	Capacity(A)	Length(L)
HSN 80	HSR-2□50□□	50(A)	80 mm
HSN 120	HSR-2□70□□	70(A)	120 mm

※The above contents can be changed without prior notice for improvement of performance.

Precautions during the use of Heat Sink

- Using standard heat sink is mandatory for this product.
- Even the standard heat sink is used, SSR damage may occur if the environment temperature rises or if the ventilation does not work well. (Environment temperature : over 40 °C)
- The normal SSR element is damaged at the maximum temperature of 125 °C. When the temperature of heat sink is 80 °C, the temperature of the element reaches around 125 °C. Therefore, during operation, measure the temperature of heat sink.
- When you connect SSR onto the heat sink, heat-transmitting grease is needed for smooth heat transmission.
- To prevent separation by vibration, tighten up with bolts.
- Do not use any insulating materials such as wood, plastic or rubber. The standard heat sink must be greased on the bottom side as shown below and connected.

※The heatproof silicon grease must be applied thoroughly on the heat sink as well as the bottom of SSR. The case side of heat sink needs to be installed on up and down directions

