

Kemro

AM 280/B

Analog hybrid module

Project engineering manual V1.06

Translation of the original instructions

KEBA[®]

Automation by innovation.

Document : V1.06 / article no.: 1000353
Filename : am280bpjen.pdf
Pages : 25

© KEBA 2011

Specifications are subject to change due to further technical developments. Details presented may be subject to correction.

All rights reserved.

A: KEBA AG, Gewerbepark Urfahr, A-4041 Linz, Tel.: +43 732 7090-0, Fax: +43 732 7309-10, E-Mail: keba@keba.com
D: KEBA GmbH Automation, Leonhard-Weiss-Straße 40, D-73037 Göppingen, Tel.: +49 7161 9741-0, Fax: +49 7161 9741-40, E-Mail: keba@keba.com
US: KEBA Corp., 100 West Big Beaver Road, Troy, MI 48084, US, Tel.: +1 248 526-0561, Fax: +1 248 526-0562, E-Mail: usa@keba.com
CN: Beijing Austrian KEBA Science and Technology Development Ltd., Room B516, Nan Xin Cang Tower, A22 Dong Si Shi Tiao, Dong Cheng District, Beijing, 100027, P.R. China, Tel. +86 10 6409-6592, Fax +86 10 6409-6312, E-Mail: china@keba.com

www.keba.com

Record of Revision

Version	Date	Change in chapter	Description	changed by
1.00			Newly created	meis
1.01	08-2006	Creation of cfg-files	updated	meis
1.02	07-2007		New structuring of the project engineering manual	meis
1.03	11-2007	Technical data	detailed power ratings	meis
1.04	06-2010		Update EN 61131-2:2007	wgr
1.05	08-2010	Declaration of conformity		hasl
1.06	08-2011	Introduction	Hint "not for end customers" added, various minor updates.	fstl

Table of Contents

1	Introduction	7
1.1	Purpose of the document.....	7
1.2	Preconditions.....	7
1.3	Intended use.....	8
1.4	Notes on this document.....	8
1.4.1	Contents of the document.....	8
1.5	Documentation for further reading.....	8
2	Safety notes	10
2.1	Representation.....	10
2.2	General safety instructions.....	10
3	Description of the module	12
3.1	Front view.....	12
3.2	Accessories.....	12
3.2.1	Connector strip.....	12
4	Connections and wiring	14
4.1	Connection of the shield-rail for analog signals.....	14
4.1.1	Notes on wiring the analog lines.....	14
4.2	Analog inputs.....	14
4.2.1	Anschlussbeispiel.....	15
4.2.2	Connection diagram.....	15
4.3	Analog outputs.....	16
4.3.1	Connection example.....	16
4.3.2	Connection diagram.....	17
4.4	EMC and wiring guidelines.....	17
5	Configuration	18
5.1	Setting the K-Bus address.....	18
6	Operating behavior	20
6.1	Response of the analog inputs.....	20
6.2	Behavior during a fault.....	20
6.2.1	Module errors.....	20
6.2.2	Sensor failure.....	20
7	Disposal	21
7.1	Disposal of the module.....	21
8	Technical data	22
8.1	In general.....	22
8.2	Environmental conditions.....	22
8.3	Analog inputs.....	22
8.4	Analog outputs.....	23
8.5	Interface.....	23

8.6	Dimensions.....	23
9	EC directives and standards.....	24
9.1	EC directives.....	24
9.2	Standards.....	24
9.2.1	General procedures and safety principles.....	24
9.2.2	EMC guideline.....	24
9.2.3	Electrical safety and fire protection.....	24
9.2.4	Environmental and surrounding conditions.....	24
9.3	Standards for the American market.....	24
9.3.1	UL test for industrial control equipment.....	24
10	Declaration of conformity.....	25

1 Introduction

1.1 Purpose of the document

This document describes the structure of the AM 280/B (analog input/output module).

Information

This manual is not addressed to end costumers! Necessary safety notes for the end costumer have to be taken into the costumer manual in the respective national language by the machine builders and system providers.

1.2 Preconditions

This document contains information for persons with the following skills:

Target group	Knowledge and skills pre-requirement
Project engineer	<p>Basic technical training (University of Applied Science/University level, engineering degree or corresponding professional experience).</p> <p>Knowledge in:</p> <ul style="list-style-type: none"> • working mode of a PLC, • safety regulations, • the application.
Operator	<p>Basic technical training (Vocational high school, engineering degree or corresponding professional experience).</p> <p>Knowledge in:</p> <ul style="list-style-type: none"> • safety regulations, • working mode of machine or plant, • principal functions of the application, • system analysis and troubleshooting, • setting options at the operating installations.
Service technician	<p>Basic technical training (Vocational high school, engineering degree or corresponding professional experience).</p> <p>Knowledge in:</p> <ul style="list-style-type: none"> • working mode of a PLC, • safety regulations, • working mode of machine or plant, • diagnosis possibilities, • systematic error analysis and rectification.

1.3 Intended use

The AM 280/B was developed for control applications in industrial machines. The typical applications areas include injection molding machines, robots, presses, machine tools and similar.

The AM 280/B may only be used for the types of use described in the technical descriptions and only in conjunction with recommended/approved third-party equipment/installations.

The AM 280/B has been developed, manufactured, tested and documented in accordance with the appropriate safety standards. Therefore, the products do not pose any danger to the health of persons or a risk of damage to other property or equipment under normal circumstances, provided that the instructions and safety precautions relating to the intended use are properly observed.

1.4 Notes on this document

This manual is integral part of the product. It is to be retained over the entire life cycle of the product and should be forwarded to any subsequent owners or users of the product.

1.4.1 Contents of the document

- Description of the module AM 280/B
- Description of wiring (including EMC guidelines)
- Technical data

1.5 Documentation for further reading

The following documents are to be observed depending on the system solution used:

If you are using the KeStudio U2 tool suite:

Doc.No.	Name	Target group
DE: 65352 EN: 65353	K2-200 automation system manual	<ul style="list-style-type: none"> • Project engineer • Electrician • Programmer • Commissioning foreman • Service technician

If you are using the KeStudio U3 tool suite:

Doc.No.	Name	Target group
DE: 1000868 EN: 1000869	System manual Kemro automation system	<ul style="list-style-type: none">• Project engineer• Electrician• Programmer• Commissioning foreman• Service technician

2 Safety notes

2.1 Representation

At various points in this manual you will see notes and precautionary warnings regarding possible hazards. The symbols used have the following meaning:



DANGER!

- indicates an imminently hazardous situation which will result in death or serious bodily injury if the corresponding precautions are not taken.
-



WARNING!

- indicates a potentially hazardous situation which can result in death or serious bodily injury if the corresponding precautions are not taken.
-



CAUTION!

- means that if the corresponding safety measures are not taken, a potentially hazardous situation can occur that may result in property injury or slight bodily injury.
-

CAUTION

- CAUTION used without the safety alert symbol indicates a potentially hazardous situation which, if not avoided, may result in damage to property.
-



- This symbol reminds you of the possible consequences of touching electrostatically sensitive components.
-

Information

Useful practical tips and information on the use of equipment are identified by the "Information" symbol. They do not contain any information that warns about potentially dangerous or harmful functions.

2.2 General safety instructions



WARNING!

- It is absolutely essential to observe the safety instructions in the system manual.
 - The module is defined as "open type equipment" (UL508) or as "offenes Betriebsmittel" (EN 61131-2) and must therefore be installed in a control cabinet.
-

CAUTION

Improper use of the assembly or the control system leads to irreparable damage!

- Turn off the power supply before inserting or removing the module. Otherwise, the module can be destroyed or undefined signal states can lead to damage of the control system.
-

3 Description of the module

The AM 280/B is an analog Input/Output module with 4 analog power inputs and 4 analog power outputs.

3.1 Front view

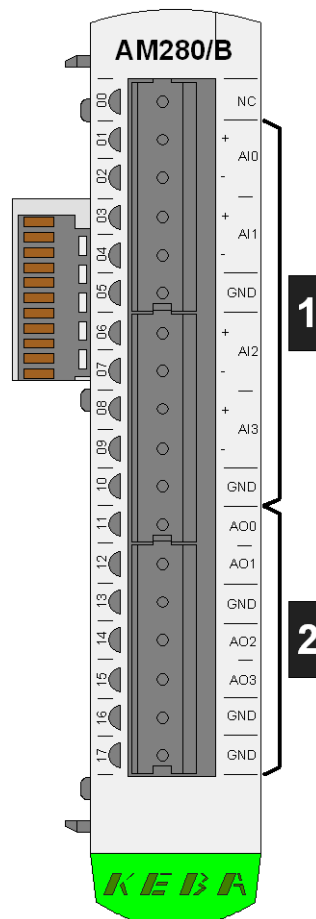

Fig.3-1: AM 280/B Front view

1	... 4 analog inputs
2	... 4 analog outputs

3.2 Accessories

3.2.1 Connector strip

Input-/output signals: Standard male connectors with grid dimension 5.08 mm

The following female connectors can be used for the AM 280/B:

Female connector	Color	Order no. Weidmüller
2-pole	sw	BLZF 5.08/2 SN SW - 170769
4-pole	sw	BLZF 5.08/4 SN SW - 170771
6-pole	sw	BLZF 5.08/6 SN SW - 170773
8-pole	sw	BLZF 5.08/8 SN SW - 170775

Information

Larger terminal blocks may be used to group multiple signals. The current carrying capacity of the terminal block is thus, however, reduced (according to derating curve of the terminal block manufacturer.)

The appropriate female connectors are not included in the delivery of KEBA, but can be purchased from KEBA.

The technical data for the terminals are contained in the technical data sheet of the manufacturer of the female connectors.

For further information see System manual.

4 Connections and wiring

4.1 Connection of the shield-rail for analog signals

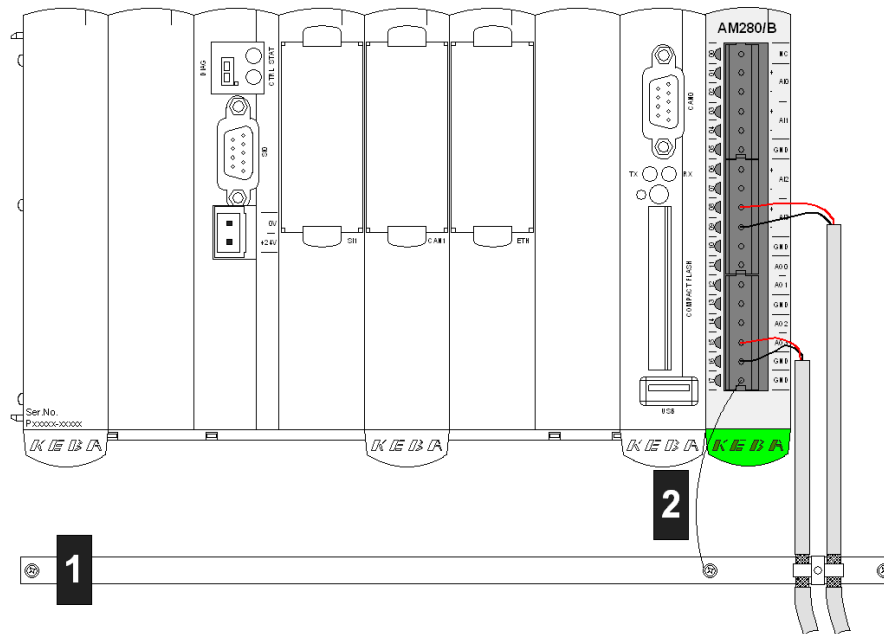

Fig.4-1: Connection of the shield-rail for analog signals

1	... Shield rail
2	... GND connection against 50 Hz field, length max. 1 m

4.1.1 Notes on wiring the analog lines

- Analog lines must be connected with a shielded cable.
- The shield rail must be connected to the GND terminal at one point.
- The shield must be placed on the shield rail as shown above.
- To attain optimum interference immunity, analog lines should not be laid out parallel to strong interfering lines (e.g. lines of converters for motors).

4.2 Analog inputs

There are 4 analog inputs with 14-bit resolution available.

4.2.1 Anschlussbeispiel

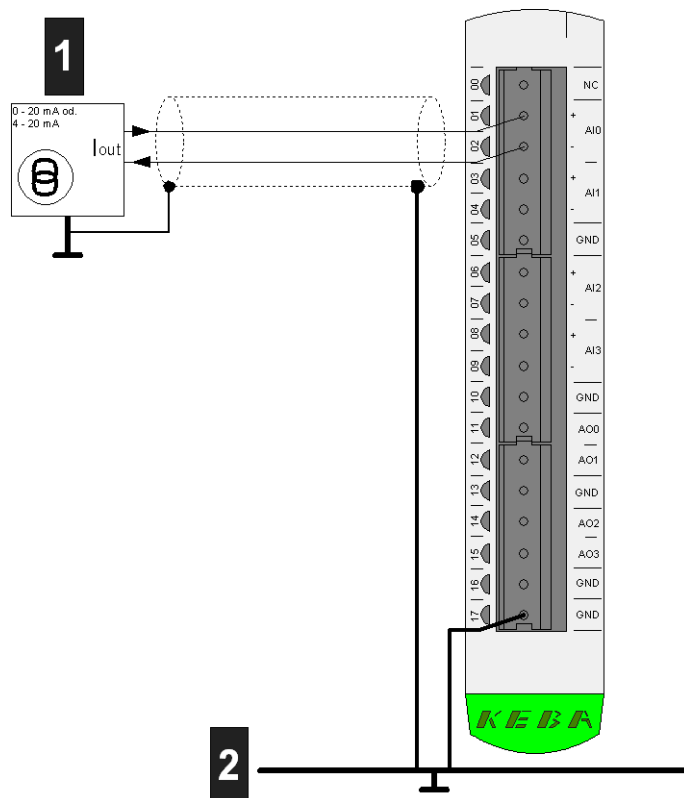

Fig.4-2: Connection example for analog inputs

1	... Sensor
2	... Shield rail

4.2.2 Connection diagram

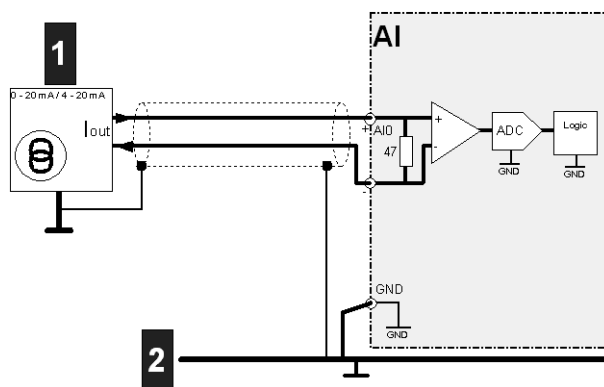

Fig.4-3: Connection diagram analog inputs

1	... Sensor
2	... Shield rail

Information on the hardware endpoints: See System manual.

4.3 Analog outputs

4 analog outputs with 12-bit resolution are available.

4.3.1 Connection example

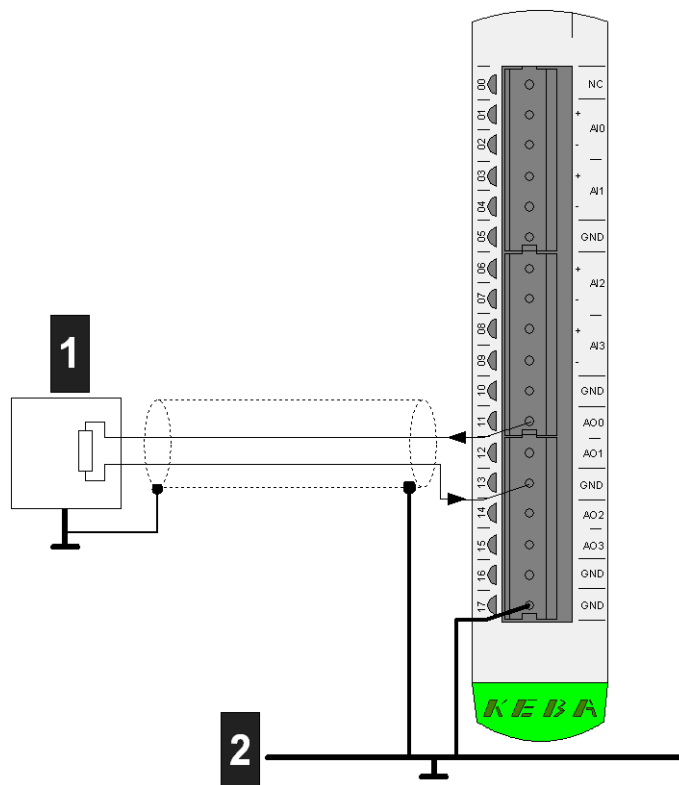

Fig.4-4: Connection example for analog outputs

1	... Actor
2	... Shield rail

4.3.2 Connection diagram

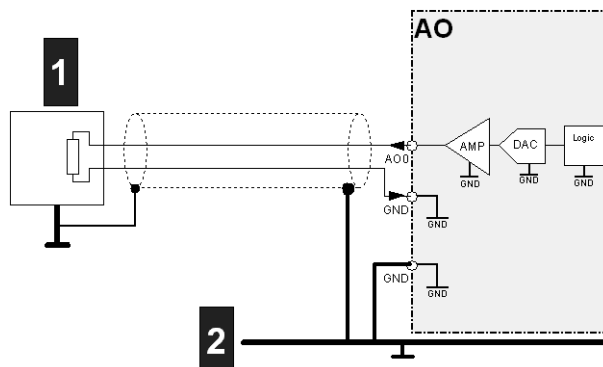

Fig.4-5: Connection diagram for analog outputs

1	... Actor
2	... Shield rail

Information on the hardware endpoints: See System manual.

4.4 EMC and wiring guidelines

Pay attention from the outset to careful wiring and shielding.

Further information: See system manual.

5 Configuration

General information

A Kemro system needs data for the configuration of system performance, its I/O-devices and interfaces. The system reads this data during the start-up operation and allocates them to its components and devices.

Configuration data is created by included configuration tools or by editing configuration files.

For further information to the configuration see the documentation of the included configuration tool.

For further information to the configuration see the documentation of the included configuration tool.

5.1 Setting the K-Bus address

The module is addressed via the address switch. A maximum of 12 modules of the same type can be distinguished on one line.

The address switch is located on the right side underneath the lower cover (the K-Bus plug is located underneath the upper cover).

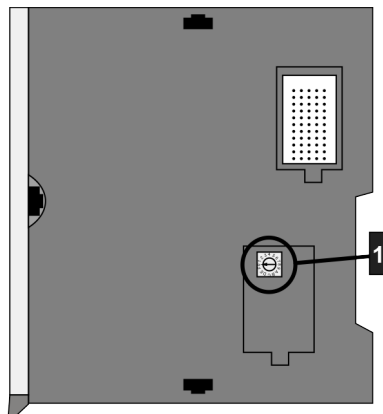

Fig.5-1: Position of the address switch

1 ... Address switch

On leaving the factory all modules are set to address 0 and both covers are closed.

Information

Modules of the same type that are installed within the same line must have different address switch positions. Different modules (e.g. analog and digital modules) may have the same address switch positions.

The two covers for the K-Bus plug and the address switch must remain locked at the last module in the line (to protect against dirt and damage through electrostatic discharge on contact).

6 Operating behavior

6.1 Response of the analog inputs

The input switch has a usable input range from -0.8 mA – 20.8 mA. The range -0.8 mA ... 0 mA or 20 mA ...20.8 mA is available as saturation range.

6.2 Behavior during a fault

6.2.1 Module errors

In case of a module error an internal watchdog monitor will be triggered. In this case the outputs will be set to 0 mA, the module is reset and signals the module error to the CPU module. The AM 280/B module is no longer operative after a watchdog reset and should therefore be replaced.

6.2.2 Sensor failure

If the module is configured for an input range from 4 – 20 mA, the range from 0 – 4 mA is used for sensor failure monitoring. The operating threshold of the sensor failure is at 2 mA, if the incoming current falls below this operating threshold, a sensor failure is triggered and transmitted to the CPU. Once the sensor failure has been corrected the status "Sensor failure" will be automatically reset.

7 Disposal

7.1 Disposal of the module

CAUTION

Please observe the regulations regarding disposal of electric appliances and electronic devices!



- The symbol with the crossed-out waste container means that electrical and electronic devices including their accessories must not be disposed of in the household garbage.
- The materials are recyclable in accordance with their labeling. You can make an important contribution to protecting our environment by reusing, renewing and recycling materials and old appliances.

8 Technical data

8.1 In general

Power supply voltage:	24 V DC from K Bus
	5 V DC from K Bus
Overvoltage category:	II
Equipment class:	III according to EN 61131-2:2007
Addressing at K-Bus:	Via 16-digit address switch, on the side
Connection terminals:	Open terminals, grid dimension: 5.08 mm
Max. power consumption K Bus 24 V:	3.6 W
Max. power consumption K Bus 5 V:	0.3 W

8.2 Environmental conditions

Operating temperature:	+5 °C to +55 °C
Storage temperature:	-40 °C to 70 °C
Relative humidity of air:	10 % to 95 % (non condensing)
Vibration resistance:	according to EN 61131-2:2007
Shock resistance:	according to EN 61131-2:2007

8.3 Analog inputs

Number of inputs:	4
Type:	Current input
Signal range:	0 – 20 mA or 4 – 20 mA
Maximum measurement signal:	-0.8 mA to 20.8 mA
Input type:	Differential
Galvanic isolation:	No
Scan repeat cycle:	1 ms
Input impedance at signal range:	< 200 Ω
Input filter characteristic – order:	First order
Input filter characteristic – transition frequency:	250 Hz
Digital resolution:	14 Bit
Transformation method:	Successive approximation
Monotonicity without error codes:	Yes
Synchronicity control:	±13.5 V
Synchronicity suppression:	>80 dB
Value of the lowest-value Bit (LSB):	1.35 μA

Maximum permitted continuous overload (without damage):	± 30 V
Typ. temp. coefficient measurement error:	± 5 ppm of FSV* / °C
Max. temp. coefficient measurement error:	± 20 ppm of FSV* / °C
Biggest error at 25° C:	$\pm 0.01\%$ of FSV*

SKE ... Scale end value

8.4 Analog outputs

Number of outputs:	4
Type:	Current output
Signal range:	0 – 20 mA
Galvanic isolation:	No
Conversion cycle:	1 ms
Digital resolution:	12 Bit
Value of the lowest-value Bit (LSB):	5.39 μ A
Monotonicity:	Yes
Load resistance:	≤ 600 Ω
Differential non-linearity:	$\leq \pm 1$ LSB
Settling time at change over the full range (at ohmic load):	≤ 50 μ s
Typ. temp. coefficient analog output error:	± 20 ppm of FSV* / °C
Max. temp. coefficient analog output error:	± 30 ppm of FSV* / °C
Biggest error at 25° C:	$\pm 0.15\%$ of FSV*

SKE ... Scale end value

8.5 Interface

System bus interface:	Parallel bus interfaces, plug-in on side
-----------------------	--

8.6 Dimensions

Dimensions:	
• Module height:	120 mm
• Mounting depth:	100 mm
• Front panel width:	22.5 mm
• Module width (incl. K-Bus plug):	32.5 mm
Weight:	135 g

9 EC directives and standards

9.1 EC directives

Guideline 2004/108/EG	EC guideline on electromagnetic compatibility
Guideline 2002/95/EG	RoHS guideline

9.2 Standards

To check the conformity of the system with the directives, the following non-binding legal European standards were applied:

9.2.1 General procedures and safety principles

EN 61131-1:2003	Programmable controllers - Part 1
-----------------	-----------------------------------

Information

This product was developed for the use in industrial areas and can cause radio interference when used in residential areas.

9.2.2 EMC guideline

EN 61131-2:2007	Programmable controllers - Part 2
-----------------	-----------------------------------

9.2.3 Electrical safety and fire protection

EN 61131-2:2007	Programmable controllers - Part 2
-----------------	-----------------------------------

9.2.4 Environmental and surrounding conditions

EN 61131-2:2007	Programmable controllers - Part 2
-----------------	-----------------------------------

9.3 Standards for the American market

9.3.1 UL test for industrial control equipment

UL 508, 2005	Industrial Control Equipment
--------------	------------------------------

10 Declaration of conformity



EC Declaration of Conformity



KEBA AG
Gewerbepark Urfahr
4041 Linz
AUSTRIA

Document No.: 68367/CE/2

We declare that the following product(s)

Name of product: AM 28x
 Variants: AM 280/A, AM 280/B, AM 282/A
 From: revision 02 (Mat.Nr. 73223)
 revision 02 (Mat.Nr. 73144)
 revision 02 (Mat.Nr. 76794)
 revision 03 (Mat.Nr. 86367)
 revision 03 (Mat.Nr. 86368)
 revision 03 (Mat.Nr. 86369)
 revision 00 (Mat.Nr. 81582)

is/are in conformity with the essential requirements of the following European Council Directive(s):

∞ EC-Directive relating to electromagnetic compatibility 2004/108/EC

Conformity to the directive 2004/108/EC is assured by the compliance with the applicable parts of the following harmonized european standards:

∞ EN 61131-2:2007

Important notes:

Any modification on the product(s), that is performed without KEBA's consent will render this declaration invalid.

This declaration certifies the conformity with the directives mentioned, but does not imply any warranty of the features of the product(s).

The safety instructions contained in the documentation supplied with the product(s) must be followed.