

User's Manual

**LG Programmable Logic Controller
High Speed Counter Module**

GLOFA

G4F-HO1A

G4F-HD1A

MASTER-

G6F-HO1A

G6F-HD1A



LG Industrial Systems

Before Using the Product...

Before using the product, please read this user's manual thoroughly for the effective use of the product.

◆ Notices for the Safety ◆

- ▶ Notices for the Safety should be complied by the user to use the product safely and correctly to prevent the occurrence of any accident or danger.
- ▶ Notices is divided by 'Warning' and 'Caution' and each meaning is as follows ;



Warning

: in case of violating the instructions, it may cause the significant injury or death.



Caution

: in case of violating the instructions, it may cause the slight injury or product damage.

- ▶ The meaning of symbols used in the product and user's manual is as follows:



means "to take care as the danger may occur under the specific conditions".



means "to take care as the electric shock may occur under the specific condition".

- ▶ After using the user's manual, you should keep it in the place where the users can see it easily whenever they need.

o Notices in Design



Caution

- ▶ I/O Signal/Communication Cables shall be designed apart at least 100mm from high tension wire or power cable to avoid the influence caused by the noise and the change of magnetic field.
It may cause the malfunction by the noise.
- ▶ Please take cares not to apply the lamp directly to the product in the place where lots of lamp are installed. The inflow of metal particle is not permitted as it may cause the malfunction of the product.
- ▶ In case of installation environment with metal particles, it may cause the malfunction and it is required not to flow into the metal particles when installing.

o Notices in Installation



Caution

- ▶ PLC should be used in the environment condition described in the general standard.
- ▶ If used out of general standard, it may cause the electric shock, fire, malfunction, damage of product or furious flames etc.
- ▶ Make sure that the module is fixed correctly.
- ▶ If the module is not installed correctly, it may cause the malfunction, failure or falling.

o Notices in Wiring



Caution

- ▶ The grounding of FG terminal should be used with the 3rd class grounding for PLC.
If not grounding, it may cause the malfunction.
- ▶ The wiring in PLC should be connected after confirming the rating voltage of the product and terminal layout.
- ▶ If connected to the different power from the rating or a wrong wiring, it may cause the fire or failure.
- ▶ In wiring, tighten the terminal screw with standard torque.
If the terminal screw is loosened, it may cause the short circuit or malfunction.
- ▶ Cares should be taken not to put the wire remnants or foreign materials inside the module.

o Notices in Startup and Maintenance

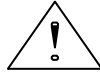

Warning

- ▶ Do not touch the terminal in the state that the power is applied. It may cause the malfunction or electric shock.
- ▶ When cleaning or tightening the terminal screw, the power should be OFF.

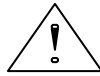

Caution

- ▶ Do not remove PCB from the module case or remodel the module. It may cause the failure, malfunction, damage of the product or fire. The installation and removal of the module should be done after Power OFF.
- ▶ The change of battery should be done in the state of power ON.
In case of changing in the power OFF, it may cause the loss of program.

o Notices in Disposal

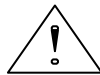

Caution

- ▶ When the product is disposed, this should be treated as industry waste.

Revision History

Issue Date	Manual number	Revised Content
2002. 10.	10310000397	First version issued.

※ User's Manual no is marked on the right bottom side of the back cover.

CHAPTER 1 INTRODUCTION1

CHAPTER 2 SPECIFICATIONS

2.1	GENERAL SPECIFICATIONS	2-1
2.2	PERFORMANCE SPECIFICATIONS	2-2
2.2.1	<i>Performance specifications</i>	2-2
2.2.2	<i>Input specifications</i>	2-3
2.2.3	<i>Preset, Gate Input / Transistor output specifications</i>	2-3
2.3	PART IDENTIFICATION NOMENCLATURE	2-4
2.3.1	<i>Part identification</i>	2-4
2.3.2	<i>Input/Output terminal</i>	2-5
2.4	BASIC USAGE	2-7
2.4.1	<i>Pulse input modes</i>	2-7
2.4.2	<i>Count mode</i>	2-10
2.4.3	<i>Coincidence output</i>	2-13
2.4.4	<i>Carry</i>	2-17
2.4.5	<i>Borrow</i>	2-17
2.4.6	<i>Supplementary functions</i>	2-18

CHAPTER 3 INSTALLATION AND WIRING

3.1	INSTALLATION.....	3-1
3.1.1	<i>Installation Ambience</i>	3-1
3.1.2	<i>Handling precautions</i>	3-1
3.2	WIRING PRECAUTIONS.....	3-1
3.2.1	<i>DC5V Output type encoder</i>	3-2
3.2.2	<i>DC12V NPN Open collector type encoder</i>	3-3
3.2.3	<i>DC24V PNP Open collector type encoder</i>	3-4
3.2.4	<i>Line driver type encoder</i>	3-5

CHAPTER 4 FUNCTION BLOCK

4.1	INSERTION OF THE FUNCTION BLOCK ON THE GMWIN.....	4-1
4.2	LOCAL FUNCTION BLOCK	4-2
4.2.1	<i>Preset setting function block (HSCB_PRE)</i>	4-2
4.2.2	<i>Count mode setting function block(HSCB_MOD)</i>	4-3
4.2.3	<i>Supplementary function setting function block (HSCB_AUX)</i>	4-4
4.2.4	<i>Coincidence output setting function block (HSCB_CMP)</i>	4-5
4.2.5	<i>Count reading function block (HSCB_CNT)</i>	4-6
4.2.6	<i>Operating information writing function block(HSCB_WR)</i>	4-7

Contents

4.2.7	<i>Operating information reading function block (HSCB_RD)</i>	4-8
4.2.8	<i>Coincidence output function block(HSCB_OUT)</i>	4-9
4.3	REMOTE FUNCTION BLOCK	4-10
4.3.1	<i>Preset setting function block (HSCBRPRE)</i>	4-10
4.3.2	<i>Count mode setting function block (HSCBRMOD)</i>	4-11
4.3.3	<i>Function setting function block (HSCBRAUX)</i>	4-12
4.3.4	<i>Coincidence output setting function block (HSCBRCMP)</i>	4-13
4.3.5	<i>Count reading function block (HSCB_CNT)</i>	4-14
4.3.6	<i>Operating information writing function block(HSCB_WR)</i>	4-15
4.3.7	<i>Operating information reading function block (HSCB_RD)</i>	4-16
4.3.8	<i>Coincidence output function block(HSCB_OUT)</i>	4-17
4.4	ERROR CODE ON THE FUNCTION BLOCK	4-18

CHAPTER 5 GM PROGRAMMING

5.1	PROGRAMMING EXAMPLE	5-1
5.1.1	<i>Linear/Ring count setting</i>	5-1
5.1.2	<i>Count mode setting</i>	5-2
5.1.3	<i>Count enable</i>	5-3
5.1.4	<i>Preset setting</i>	5-4
5.1.5	<i>Coincidence output setting</i>	5-5
5.1.6	<i>Count reading</i>	5-6
5.1.7	<i>Comparing enable and Coincidence output enable</i>	5-7
5.1.8	<i>Carry / Borrow reset</i>	5-8
5.1.9	<i>Function setting</i>	5-9
5.2	READ/ WRITE HIGH-SPEED COUNTER MODULE MOUNTED ONTO THE REMOTE STATION.....	5-14
5.3	APPLICATION EXAMPLES	5-16
5.3.1	<i>Program for moving the cart</i>	5-16
5.3.2	<i>Turntable control program</i>	5-20

CHAPTER 6 BUFFER MEMORY AND I/O SIGNAL

6.1	BLOCK DIAGRAM.....	6-1
6.2	BUFFER MEMORY CONFIGURATION.....	6-2
6.2.1	<i>Buffer memory configuration</i>	6-2
6.2.2	<i>Detail data configuration</i>	6-3
6.2.3	<i>Status display</i>	6-4
6.3	INPUT/OUTPUT SIGNAL.....	6-4

CHAPTER 7 MK PROGRAMMING

7.1	BUFFER MEMORY READ/WRITE	7-1
7.1.1	<i>Buffer memory read</i>	7-1
7.1.2	<i>Buffer memory write</i>	7-3
7.2	PROGRAMMING EXAMPLE	7-5
7.2.1	<i>Linear/Ring count selection</i>	7-5
7.2.2	<i>Count mode selection</i>	7-6
7.2.3	<i>Count enable</i>	7-6
7.2.4	<i>Preset enable(by program)</i>	7-7
7.2.5	<i>Count reading</i>	7-7
7.2.6	<i>Coincidence output selection and setting</i>	7-8
7.2.7	<i>Carry/Borrow reset</i>	7-9
7.2.8	<i>Supplementary functions</i>	7-9
7.3	APPLICATION EXAMPLE	7-14
7.3.1	<i>Cart moving program</i>	7-14
7.3.2	<i>Program for Control of the Constant Angle rotation of the Turntable</i>	7-19

CHAPTER 8 TROUBLESHOOTING

8.1	TROUBLESHOOTING	8-1
8.1.1	<i>The LED status of High Speed Counter Module</i>	8-1
8.1.2	<i>The counting status of High Speed Counter Module</i>	8-1
8.1.3	<i>The output status of High Speed Counter Module</i>	8-1
8.2	TROUBLESHOOTING PROCEDURE	8-2
8.2.1	<i>Incorrect LED status</i>	8-2
8.2.2	<i>Abnormal count operation</i>	8-3
8.2.3	<i>Abnormal count value</i>	8-4
8.2.4	<i>Abnormal output</i>	8-5

Appendix A Index

Chapter 1 Introduction

This manual describes the specifications, handling instructions, and programming information for G4F-HO1A/HD1A, G6F-HO1A/HD1A. It is the high-speed counter module used with CPU of the GLOFA PLC GM/4/6 series and the MASTER-K200S/300S series.

The G3F-HSCA, the G4F-HSCA and the G6F-HSCA consist of 24bit counting part which performs increment or decrement count, an external input part, a comparison part which compares the set value specified by the user with the current counting value, and an output part which outputs the comparison results.

High Speed Counter Module has functions as below:

1) 1 Phase

(1) Up/Down counter by program.

(2) Up/Down counter by phase B.

2) 1,2,4 multiple of phase up/down counter for 2 phase.

3) Up/Down counter by phase A/phase B for CW/CCW.

4) Preset / Gate by program and the external terminal.

5) 7 coincidence output conditions and 4 transistor outputs per channel.

6) 5 functions (Count clear, Count latch, Sampling counter, Pulse frequency counter, Periodic pulse counter)

Chapter 2 Specifications

2.1 General specifications

No.	Item	Specification	Standard			
1	Operating temperature	0 ~ 55 °C				
2	Storage temperature	-25 ~ 70 °C				
3	Operating humidity	5 ~ 95%RH, non-condensing				
4	Storage humidity	5 ~ 95%RH, non-condensing				
5	Vibration	Occasional vibration		IEC61131-2		
		Frequency	Acceleration		Amplitude	Sweep count
		$10 \leq f < 57\text{Hz}$	–		0.075mm	
		$57 \leq f \leq 150\text{Hz}$	9.8m/s ² {1G}		–	
		Continuous vibration			10 times in each direction for X, Y, Z	
		Frequency	Acceleration			Amplitude
$10 \leq f < 57\text{Hz}$	–	0.035mm				
		$57 \leq f \leq 150\text{Hz}$	4.9m/s ² {0.5G}	–		
6	Shocks	<ul style="list-style-type: none"> • Maximum shock acceleration:: 147 m/s²{15G} *Duration time :11 ms *Pulse wave: half sine wave pulse(3 times in each of X, Y and Z directions) 	IEC61131-2			
7	Noise immunity	impulse noise	± 1,500 V		LGIS Standard	
		Electrostatic discharge	Voltage :4kV(contact discharge)		IEC61131-2 IEC1000-4-2	
		Radiated electromagnetic field	27 ~ 500 MHz, 10 V/m		IEC61131-2, IEC1000-4-3	
		Fast transient burst noise	Severity Level	All power modules	Digital I/Os (Ue ≥ 24 V)	Digital I/Os (Ue < 24 V) Analog I/Os communication I/Os
Voltage	2kV		1kV	0.25kV		
8	Operating atmosphere	Free from corrosive gases and excessive dust				
9	Altitude for use	Up to 2,000m(6,562ft)				
10	Pollution degree	2 or lower				
11	Cooling method	Self-cooling				

Remark

- 1) IEC(International Electrotechnical Commission)
: The international civilian organization which produces standards for electrical and electronics industry.
- 2) Pollution degree
: It indicates a standard of operating ambient pollution level.
The pollution degree 2 means the condition in which normally, only non-conductive pollution occurs. Occasionally, however, a temporary conductivity caused by condensation shall be expected.

2.2 Performance Specifications

2.2.1 Performance specifications

Item		Specifications			
		G4F-H01A	G6F-H01A	G4F-HD1A	G6F-HD1A
Occupied I/O points		64 points			
Number of channels		2			
Count input signal	Phase	Phase A, Phase B			
	Level	DC5/12/24V		EIA RS-422A standard	
	Type	Open Collector		Line Driver	
Counting range		-2,147,483,648 ~ 2,147,483,647 (binary 32 bits)			
Counting speed		200 KHz (Max)		500 KHz(Max)	
Up/Doun count setting	1 Phase input	Program or Phase B			
	2 Phase input	Difference of phases			
	CW/CCW	Phase A input : Up count		Phase B input : Down count	
External output	Coincidence output	Out 0 Out 1 Out 2 Out 3 (>, =, <, ≤, ≥)			
External input	Preset	DC 5V / 12V / 24V			
	Gate	DC 5V / 12V / 24V			
Multiplication	1 Phase input	1, 2 multiple of phase (set by program)			
	2 Phase input	1, 2, 4 multiple of phase (set by program)			
Functions		Count Clear, Count Latch, Sampling Count, Pulse frequency count, Periodic pulse count			
Internal current consumption		400mA	450mA	400mA	450mA
Weight		173 g	126g	184 g	134 g

2.2.2 Input specifications

Item	Level	Specifications	
		Open collector type	Differential input type
On-state voltage(Min)	DC 5 V	4.5 V	EIA RS-422A standard
	DC 12 V	11 V	
	DC 24 V	14 V	
Off-state voltage(Max)	DC 5 V	0.8 V	
	DC 12 V	1.5 V	
	DC 24 V	2.5 V	

2.2.3 Preset, Gate Input / Transistor output specifications

Item	Level	
Input voltage	DC 5V / 12V / 24V	
On-state voltage(Min)	DC 5V	DC 4.5V
	DC 12V	DC 11V
	DC 24V	DC 14V
Off-state voltage(Max)	DC 5V	DC 0.8V
	DC 12V	DC 1.5V
	DC 24V	DC 2.5V
On Delay Time	1ms or less	
Off Delay Time	1ms or less	
Coincidence output	DC 24V, 100 mA/point	
Leakage current	0.1 mA or less	
Voltage drop	2.5 V or less	
On Delay Time	0.1 ms or less	
Off Delay Time	0.1 ms or less	

2.3 Part Identification Nomenclature

2.3.1 Part identification

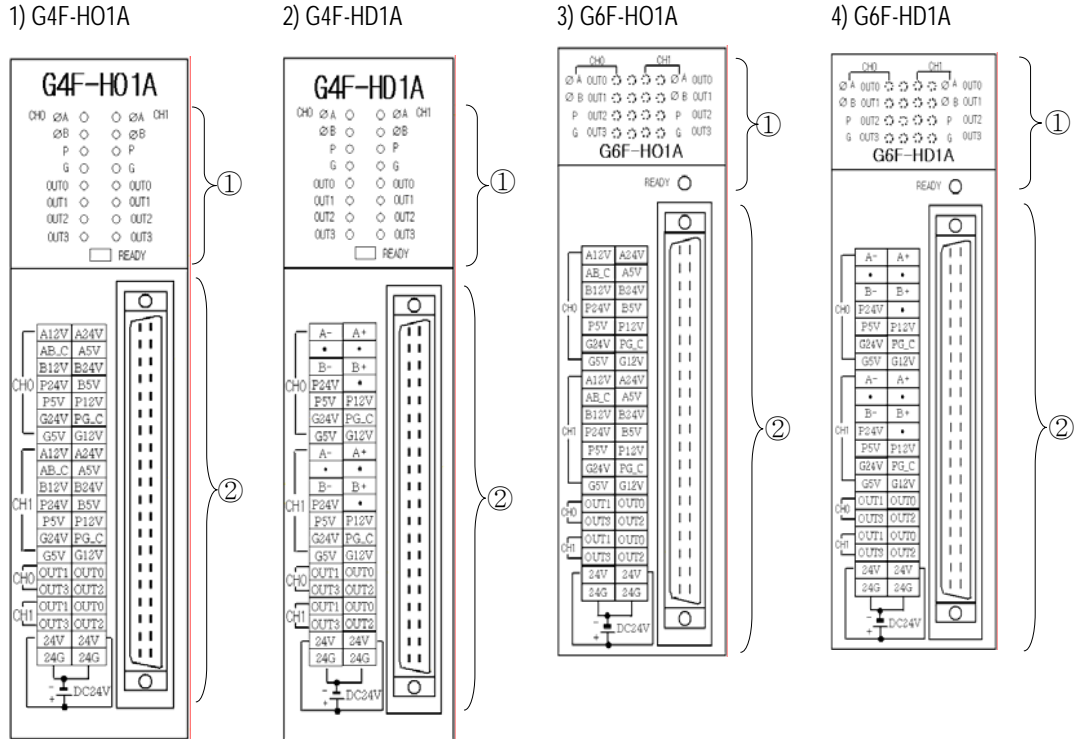

No	Name	Description	
①	LED	ØA	Phase A
		ØB	Phase B
		P	External Preset
		G	External Gate
		OUT0	OUT0 Coincidence output
		OUT1	OUT1 Coincidence output
		OUT2	OUT2 Coincidence output
		OUT3	OUT3 Coincidence output
	READY	Ready	
②	Connector	Terminal for connecting with external device	

2.3.2 Input/Output terminal

1) Pin arrangement

(1) G4F-H01A/ G6F-H01A

Terminal	Pin Number		Description		
	CH0	CH1			
	1	15	A12V	Phase A DC12V	
	2	16	A24V	Phase A DC24V	
	3	17	AB_C	Phase A/B Common	
	4	18	A5V	Phase A DC5V	
	5	19	B12V	Phase B DC12V	
	6	20	B24V	Phase B DC24V	
	7	21	P24V	Preset DC24V	
	8	22	B5V	Phase B DC5V	
	9	23	P5V	Preset DC5V	
	10	24	P12V	Preset DC12V	
	11	25	G24V	Gate DC24V	
	12	26	PG_C	Preset/Gate Common	
	13	27	G5V	Gate DC5V	
	14	28	G12V	Gate DC12V	
		29	33	OUT1	OUT1 Coincidence output
		30	34	OUT0	OUT0 Coincidence output
		31	35	OUT3	OUT3 Coincidence output
		32	36	OUT2	OUT2 Coincidence output
		37	38	24V	DC24V External source
		39	40	24G	

(2) G4F-HD1A/ G6F-HD1A

Terminal	Pin Number		Description		
	CH0	CH1			
	1	15	A-	A- 입력	
	2	16	A+	A+ 입력	
	3	17	-	-	
	4	18	-	-	
	5	19	B-	B- 입력	
	6	20	B+	B+ 입력	
	7	21	P24V	Preset DC24V	
	8	22	-	-	
	9	23	P5V	Preset DC5V	
	10	24	P12V	Preset DC12V	
	11	25	G24V	Gate DC24V	
	12	26	PG_C	Preset/Gate Common	
	13	27	G5V	Gate DC5V	
	14	28	G12V	Gate DC12V	
		29	33	OUT1	OUT1 Coincidence output
		30	34	OUT0	OUT0 Coincidence output
		31	35	OUT3	OUT3 Coincidence output
		32	36	OUT2	OUT2 Coincidence output
		37	38	24V	DC24V External source
		39	40	24G	

Chapter 2 Specifications

2) Internal Circuit

(1) G4F-HD1A/ G6F-HD1A

I/O classification	Internal circuit	No.	Terminal (CH0,CH1)	Description		Description	
				Ch0	Ch1		
Input		①	A24V	2	16	Phase A input(DC24V)	
		②	A12V	1	15	Phase A input(DC12V)	
		③	A5V	4	18	Phase A input(DC5V)	
		④	AB_COM	3	17	Phase A, B common	
		①	B24V	6	20	Phase B input(DC24V)	
		②	B12V	5	19	Phase B input(DC12V)	
		③	B5V	8	22	Phase B input(DC5V)	
		④	AB_COM	3	17	Phase A, B common	
	Input		⑤	P24V	7	21	Preset (DC 24V)
			⑥	P12V	10	24	Preset (DC 12V)
			⑦	P5V	9	23	Preset (DC 5V)
			⑧	PG_COM	12	26	Preset, Gate common
			⑤	G24V	11	25	Gate (DC 24V)
			⑥	G12V	14	28	Gate (DC 12V)
⑦			G5V	13	27	Gate (DC 5V)	
Output		⑨	OUT0	30	34	Coincidence output 0	
		⑩	OUT1	29	33	Coincidence output 1	
		⑪	OUT2	32	36	Coincidence output 2	
		⑫	OUT3	31	35	Coincidence output 3	
		⑬	24V	37	38	External source DC 24V	
		⑭	24G	39	40	External source COM	

(2) G4F-HD1A/ G6F-HD1A

I/O classification	Internal circuit	No.	Terminal (CH0,CH1)	Description		Description	
				Ch0	Ch1		
Input		①	A+	2	16	Phase A+ input	
		②	A-	1	15	Phase A- input	
		③	B+	6	20	Phase B+ input	
		④	B-	5	19	Phase B- input	
	Input		⑤	P24V	7	21	Preset (DC 24V)
			⑥	P12V	10	24	Preset (DC 12V)
			⑦	P5V	9	23	Preset (DC 5V)
			⑧	PG_COM	12	26	Preset, Gate common
			⑤	G24V	11	25	Gate (DC 24V)
			⑥	G12V	14	28	Gate (DC 12V)
			⑦	G5V	13	27	Gate (DC 5V)
	Output		⑨	OUT0	30	34	Coincidence output 0
			⑩	OUT1	29	33	Coincidence output 1
			⑪	OUT2	32	36	Coincidence output 2
⑫			OUT3	31	35	Coincidence output 3	
⑬			24V	37	38	External source DC 24V	
⑭			24G	39	40	External source COM	

2.4 Basic usage

- The High-speed count module can count high-speed pulse which cannot be proceed with the CPU counting instructions (CTU,CTUD, etc.). Up to 32 bits binary (-2,147,483,648 ~ 2,147,483,647) can be counted.
- High speed count module has 7 pulse input modes; 1 phase multiple of 1(up/down count by program), 1 phase multiple of 2(up/down count by program), 1 phase multiple of 1(up/down count by phase B), 1 phase multiple of 2(up/down count phase B),CW/CCW, 2 phase multiple of 1, 2 phase multiple of 2, 2 phase multiple of 4.
- High speed count module has 2 up/down counting method ;
 - 1 phase : set by program, set by phase B
 - 2 phase : set by difference of phases
 - CW/CCW : phase A input = increment, Phase B input = decrement
- High speed count module has 5 functions ;
 - Count clear, Count latch, Sampling count, Pulse frequency count, and Periodic pulse count.

2.4.1 Pulse input modes

1) 1 Phase pulse input

(1) Up/down count by program

(A) 1 phase multiple of 1

Counting is executed at the rising edge of phase A and either up count or down count is selected by program.

Low/high	Phase A rise	Phase A fall
Up/down count selecting signal Off	Up count	-
Up/down count selecting signal On	Down count	-

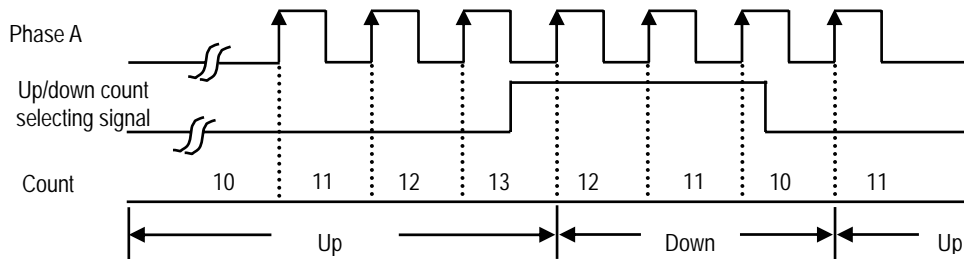

(B) 1 phase multiple of 2

Counting is executed at the rising edge/ falling edge of phase A and either up count or down count is selected by program.

Low/high	Phase A rise	Phase A fall
Up/down count selecting signal Off	Up count	Up count
Up/down count selecting signal On	Down count	Down count

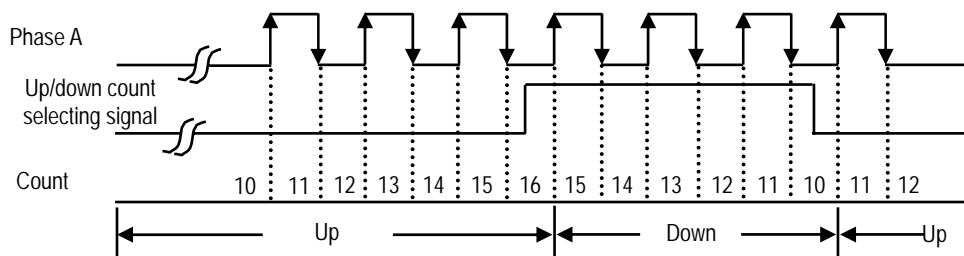

Chapter 2 Specifications

(2) Up/down count by phase B

(A) 1 phase multiple of 1

Counting is executed at the rising edge of phase A and either up count or down count is selected by phase B.

Low/high	Phase A rise	Phase A fall
Phase B Low	Up count	-
Phase B High	Down count	-

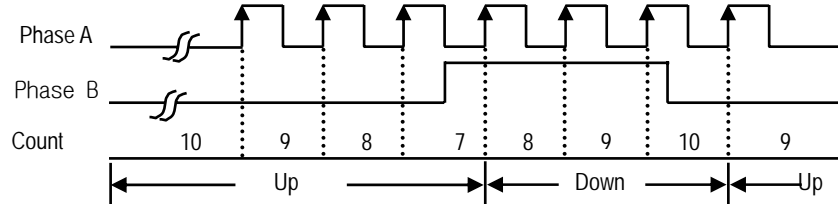

(B) 1 phase multiple of 2

Counting is executed at the rising edge/ falling edge of phase A and either up count or down count is selected by phase B.

Low/high	Phase A rise	Phase A fall
Phase B Low	Up count	Up count
Phase B High	Down count	Down count

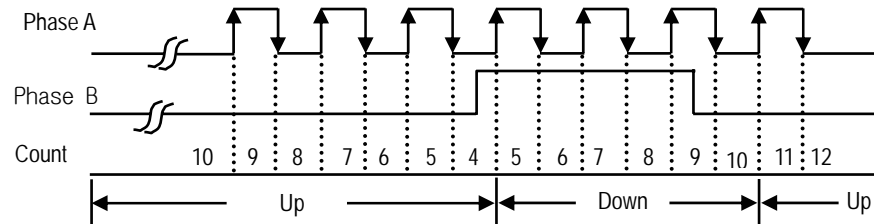

2) 2 phase (up/down count by difference of phases)

(1) 2 phase multiple of 1

Up/down count is executed by the difference of phase A and phase B.

When phase A leads phase B, Up count is executed at the rising edge of phase A, when phase B leads phase B down count is executed at the falling edge of phase A.

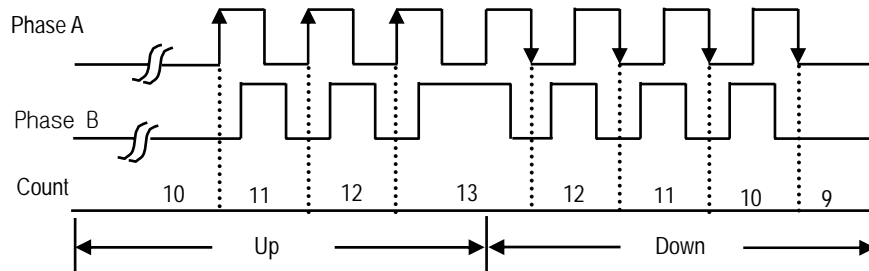

Chapter 2 Specifications

(2) 2 phase multiple of 2

Up/down count is executed by the difference of phase A and phase B at the rising edge and falling edge of phase A.

when phase A leads phase B up count is executed and when phase B leads phase A down count is executed.

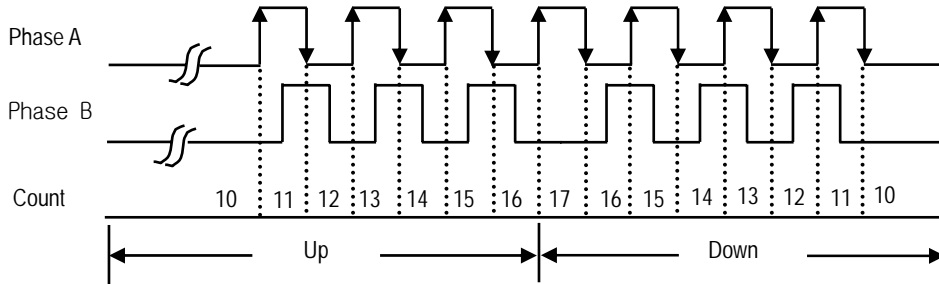

(3) 2 phase multiple of 4

Up/down count is executed by the difference of phase A and phase B at the rising edge and falling edge of phase A / pahse B.

when phase A leads phase B up count is executed and when phase B leads phase A down count is executed.

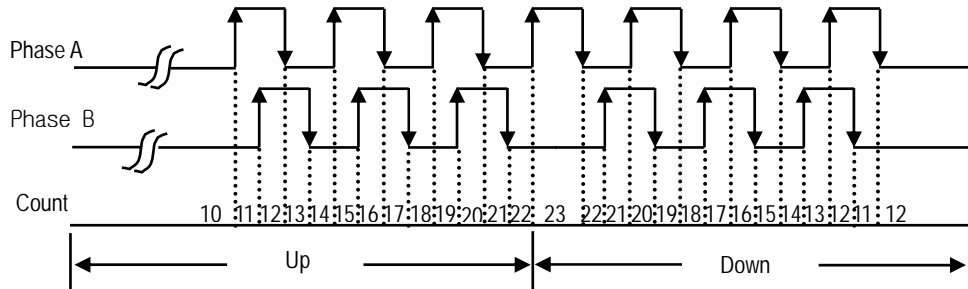

3) CW(Clockwise)/CCW(Counter Clockwise)

Counting is executed at the rising edge/ falling edge of phase A and phase B.

The relationship between phase A pulse input and phase B pulse input is shown below.

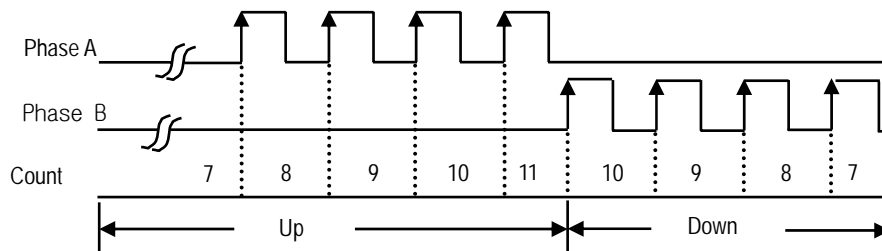

2.4.2 Count mode

Count is used 2 method as follows according to function.

Selection	GLOFA GM	MASTER-K
	Function block HSCB_MOD's SEL	Address 1 for Ch 0, 33 for Ch1
Linear count	"0"	"0"
Ring count	"1"	"1"

1) Linear count

- Count range : -2,147,483,648 ~ 2,147,483,647 (32bit signed binary values)
- When count value reaches at the maximum value carry is occurs and when count value reaches at the minimum value borrow is occurred.
- If carry occurs, counting stops and no more up-count is performed but down-count is possible.
- If borrow occurs, counting stops and no more down-count is performed but up-count is possible.

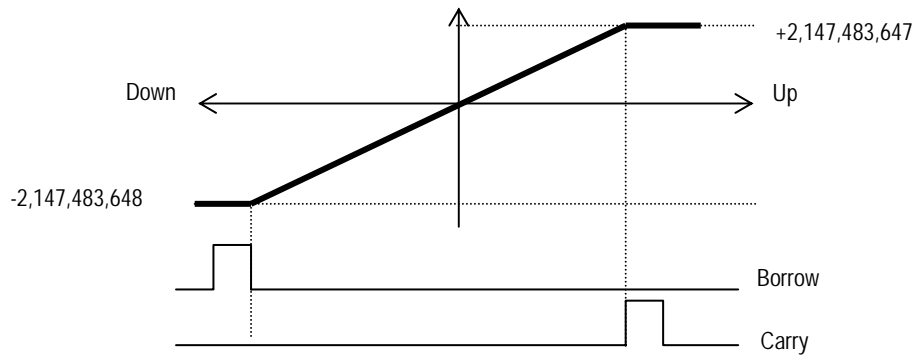

2) Ring count

- Count range : user-defined minimum value ~ user-defined maximum value.
- Count display: when performing the ring count, the user-defined minimum value is displayed but maximum value is not displayed. This is same at up count and down count.

(1) Up count

when the count value exceeds the user-defined maximum value, carry occurs but the counting is executed continuously. Detail figure for up count is shown as below.

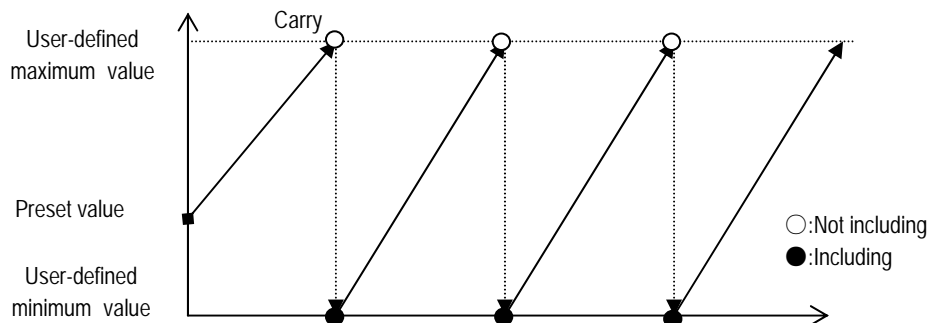

(2) Down count

- when the count value exceeds the user-defined minimum value, borrow occurs but the counting is executed continuously. Detail figure for up count is shown as below.

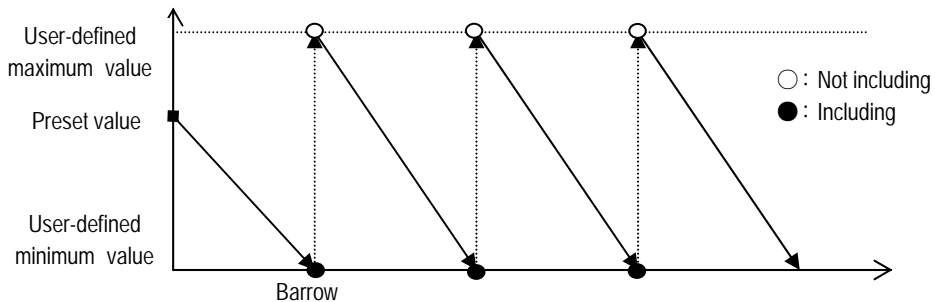

(3) Ring count execution according to the preset value (for up count)

- When the preset value is set out of the user-defined maximum / minimum value.,
 - Count value increases and at the user-defined minimum value if adding one pulse, the count value goes up to the user-defined maximum value and then up count goes on.
 - When the count value exceeds 2,147,483,647, carry occurs and the count value goes down to -2,147,483,648 and then up count goes on.
- When the preset value is set within the user-defined maximum / minimum value.,
 - Up count value increases and at the user-defined maximum value if adding one pulse, the count value goes down to the user-defined minimum value and then up count goes on.
 - When the count value goes from the user-defined maximum value to user-defined minimum value, carry occurs.

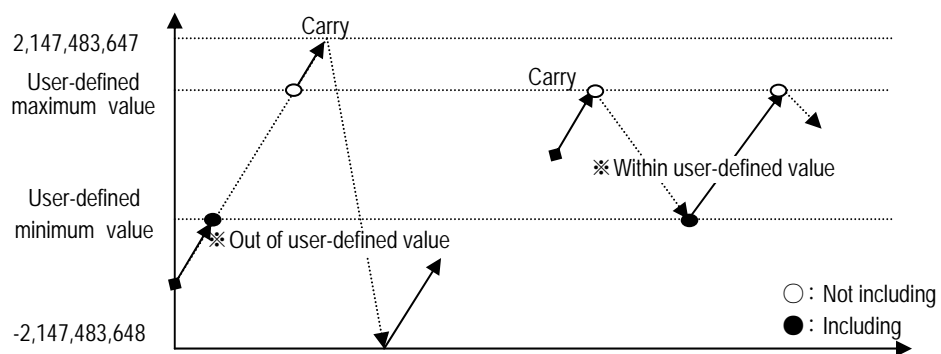

(4) Ring count execution according to preset value (for down count)

- When the preset value is set out of the user-defined maximum / minimum value.,
 - Count value decreases and at the user-defined maximum value if adding one pulse, the count value goes up to the user-defined minimum value and then down count goes on.
 - When the count value exceeds -2,147,483,647, borrow occurs and the count value goes down to 2,147,483,648 and then down count goes on.
- When the preset value is set within the user-defined maximum / minimum value.,
 - Down count value exceeds and at the user-defined minimum value if adding one pulse, the count value goes up to the user-defined maximum value and then down count goes on.
 - When the count value goes from user-defined minimum value to the user-defined maximum value, borrow occurs.

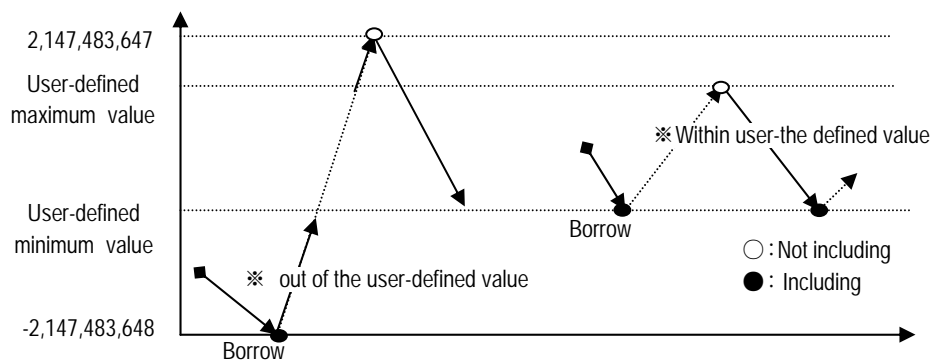

Remark

1. Whether the ring count value is counted within the user defined value or not, it depends on the count value at the time when the ring count is set.
2. When using the ring count, be sure to set the count value within the user defined value by using the preset value.

2.4.3 Coincidence output

- Coincidence output is a function which compares current count value with the user-defined value and output when the condition matches.
- Coincidence output can be set for 4 outputs in each channel and used independently.
- Coincidence output conditions can be set in 7 methods by $>$, $=$, $<$, combination.

Conditions	GLOFA GM	MASTER-K		
	Function block HSCB_CMP's CMPS	Output	Ch 0	Ch 1
		Out0	Address 3	Address 35
Count value $<$ User-defined value	"0"	Out1	Address 4	Address 36
Count value \leq User-defined value	"1"	Out2	Address 5	Address 37
Count value $=$ User-defined value	"2"	Out3	Address 6	Address 38
Count value \geq User-defined value	"3"			
Count value $>$ User-defined value	"4"			
User-defined value1 \leq Count value \leq User-defined value2	"5"			
User-defined value1 \geq Count value, Count value \geq User-defined value2	"6"			

- To use coincidence output, turn on the coincidence output enable command and the comparing enable command.

Signals	GLOFA GM	MASTER-K
Comparing enable command (LED Output)	Function block HSCB_OUT CMP_E = 1	Ch 0 P (n+2) 4, Ch1 P (n+3) 4 "On"
Output enable command (External output)	Function block HSCB_OUT OUT_E = 1	Chj0 P (n+2) 5, Ch1 P (n+3) 5 "On"
Coincidence output signal	Function block HSCB_OUT EQ0_R-EQ3_R = 1 (Independently)	Ch0 P(n+2)6-P(n+2)9, Ch1 P(n+3)6-P(n+3)9 "On" (Independently)

- If the coincidence output enable command is turned on and the comparing enable command is off, only LED is lit and the coincidence output is turned on.

1) Coincidence output mode 0 (count value $<$ user-defined value)

- The coincidence output is turned on when the count value is fewer than the user-defined value.

If the count value equals to or more than the user-defined value the coincidence output is turned off.

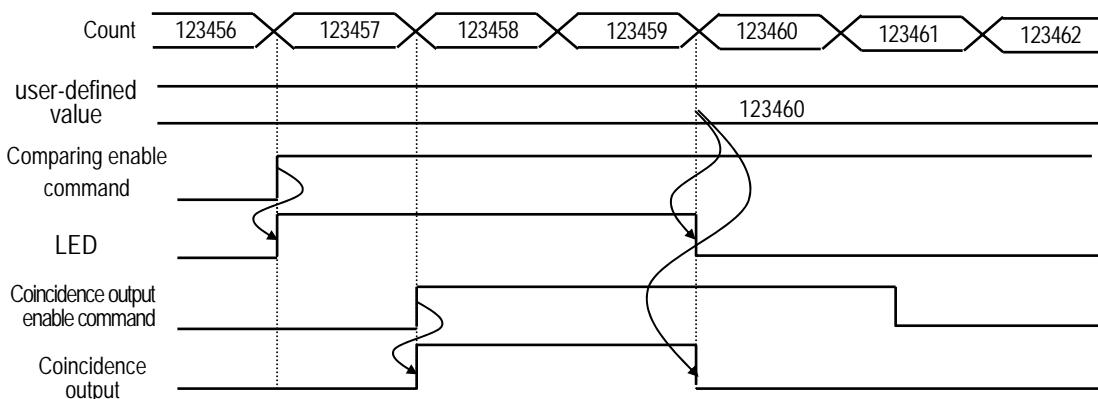

2) Coincidence output mode 1(count value \leq user-defined value)

■ The coincidence output is turned on when the count value is equal to or less than the user-defined value.

If the count value is more than the user-defined value the coincidence output is turned off.

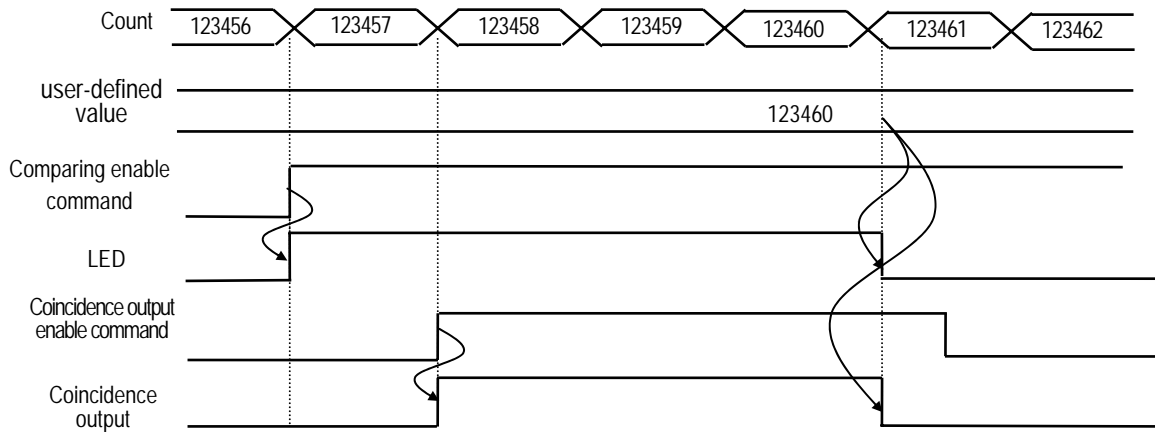

3) Coincidence output mode 2(count value \leq user-defined value)

■ The coincidence output is turned on when the count value is equal to the user-defined value.

If the coincidence output is ON, though the count value is not equal to the user-defined value, the coincidence output is not turned off.

To turn off the coincidence output, the coincidence output reset command should be ON.

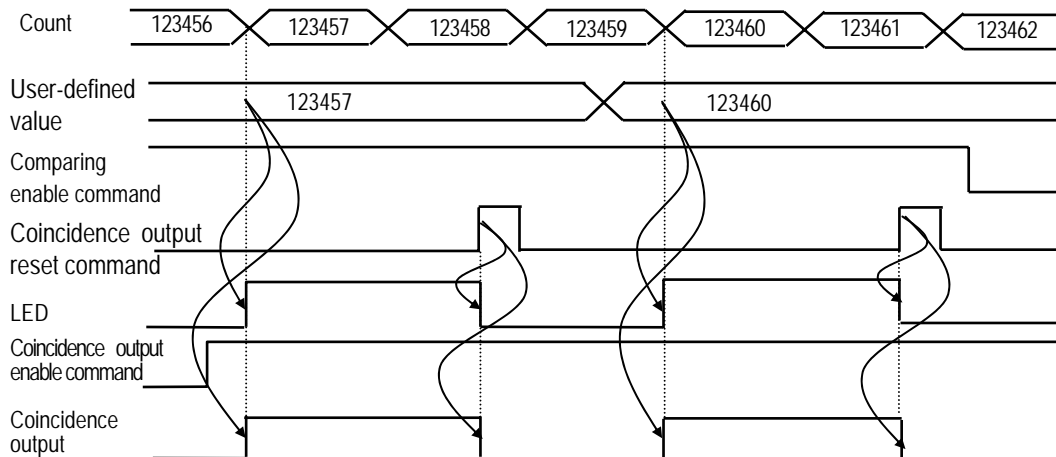

4) Coincidence output mode 3 (count value \leq user-defined value)

- The coincidence output is turned on when the count value is equal to or more than the user-defined value.

If the count value is less than the user-defined value the coincidence output is turned off.

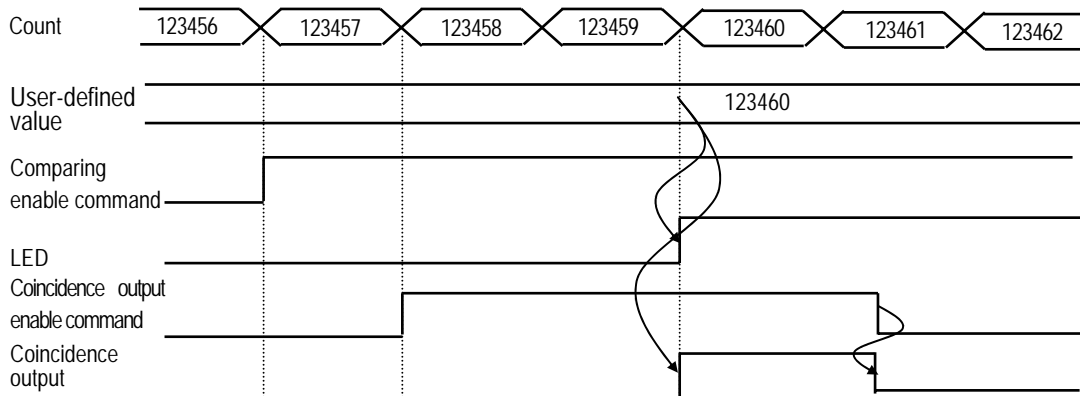

5) Coincidence output mode 4 (count value \leq user-defined value)

- The coincidence output is turned on when the count value is more than the user-defined value.

If the count value is equal to or less than the user-defined value the coincidence output is turned off.

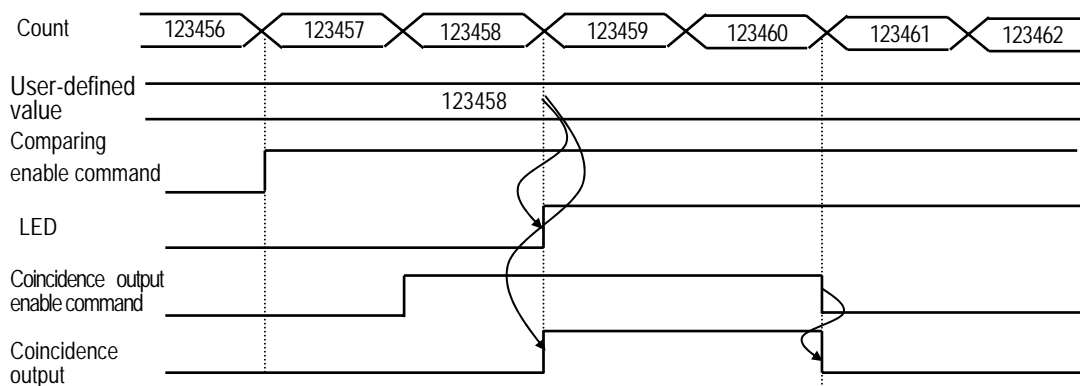

6) Coincidence output mode 5 (User-defined value1 ≤ Count value ≤ User-defined value2)

■ The coincidence output is turned on in the case of User-defined value1 ≤ Count value ≤ User-defined value2. If the count value is not within the section the coincidence output is turned off.

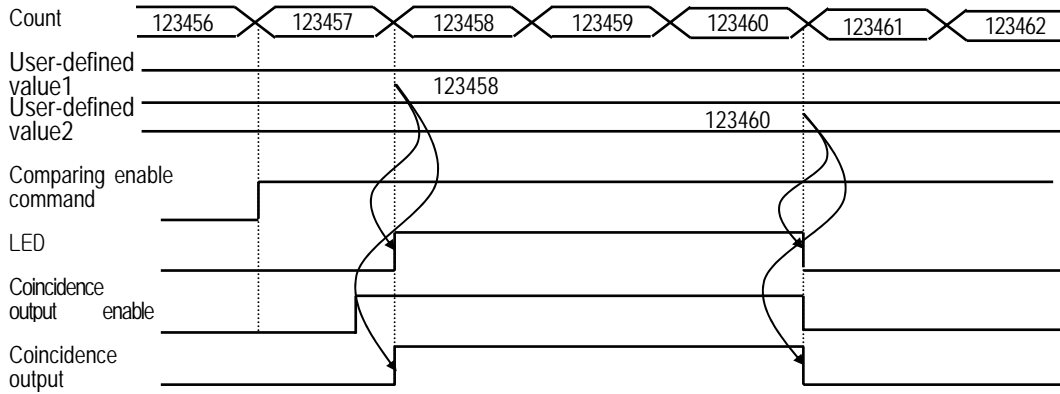

7) Coincidence output mode 6 (Count value ≤ User-defined value1 or User-defined value2 ≤ Count value)

■ The coincidence output is turned on in the case of Count value ≤ User-defined value1 or User-defined value2 ≤ Count value. If the count value is not within the section the coincidence output is turned off.

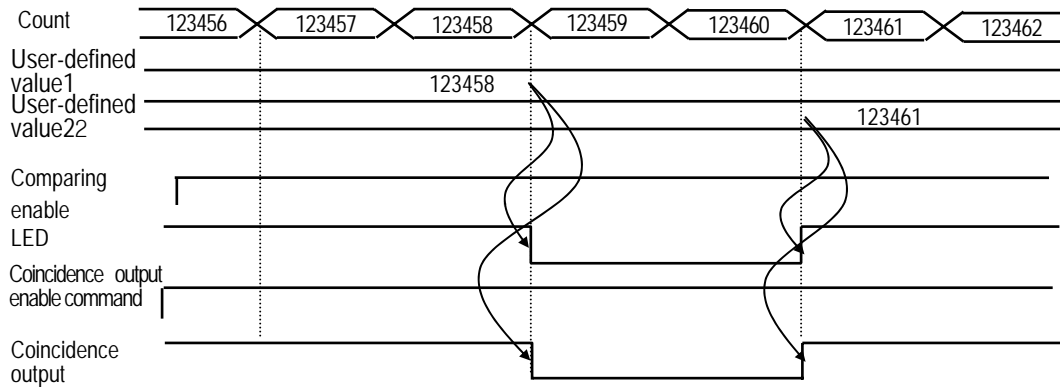

2.4.4 Carry

■ Carry occurs

- For linear count, when the count value reaches 2,147,483,647.
- For ring count, when the count value goes from the user-defined maximum value to the user-defined minimum value.

■ State of count when Carry occurs.

- For linear count, if Carry occurs count stops.
- For ring count, though Carry occurs counting goes on.

■ Carry reset

- Carry can be reset by carry/borrow reset command (HSCB_WR Function block's CY_R).

Signal	GLOFA GM	MASTER-K
Carry reset command	Function block HSCB_WR CY_R = 1	Ch 0 P(n+2)A, Ch 1 P(n+3)A "On"

2.4.5 Borrow

■ Borrow occurs

- For linear count, when the count value reaches -2,147,483,648.
- For ring count, when the count value goes from the user-defined minimum value to the user-defined maximum value.

■ State of count when Borrow occurs.

- For linear count, if Borrow occurs count stops.
- For ring count, though Borrow occurs counting goes on.

■ Borrow reset

- Borrow can be reset by carry/borrow reset command(HSCB_WR Function block's CY_R).

Signal	GLOFA GM	MASTER-K
Borrow reset command	Function block HSCB_WR CY_R = 1	Ch 0 P(n+2)A, Ch 1 P(n+3)A "On"

2.4.6 Supplementary functions

- High Speed Counter Module has 5 functions. This section describes the functions.
- For using a supplementary function the function enable command shall be "On".

Functions		GLOFA GM		MASTER-K	
Function enable command		Function block HSCB_WR AUX_E = 1		Ch 0 P(n+2)3, Ch 1 P(n+3)3 "On"	
FUNCTION	Count Clear	Function block HSCB_AUX AUX	-	Ch 0 Address 2, Ch 1 Address 34	-
	Count Latch		Count value display Function block HSCB_CNT LTCH_OLD		Count value display Ch 0 Address: 66, 67 Ch 1 Address: 82, 83
	Sampling count		Count value display Function block HSCB_CNT SCNT_NEW		Count value display Ch 0 Address: 68, 69 Ch 1 Address: 84, 85
	Pulse frequency count		Count value display Function block HSCB_CNT TIME_A/TIME_B		Phase A Ch 0 Address: 70, 71 Ch 1 Address : 86, 87 Phase B Ch 0 Address: 72, 73 Ch 0 Address: 88, 89
	Periodic count		Count value display Function block HSCB_CNT SCNT_NEW, LTCH_OLD		Previous count value Ch 0 Address: 66, 67 Ch 1 Address: 82, 83 Current count value Ch 0 Address: 68, 69 Ch 0 Address: 84, 85

1) Count Clear

- In this function, if Function enable command is ON, the count value is turned to 0.
- How to set
 - Selecting function mode 1 -> Function enable command ON .
- Count clear makes the current count value clear to 0 in each time the function enable command is ON.

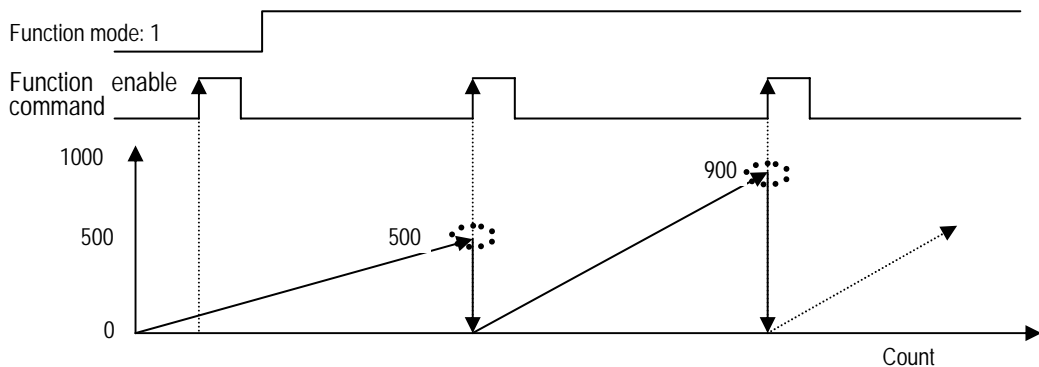

Remark

※ Function enable command : When using FB the command is AUX_E and when using the terminal after setting the supplementary function enable command(AUX_I/E in FB), Use the Gate terminal.

2) Count Latch

- In this function, if Function enable command is ON, the current count value is latched and stores the value in the internal buffer memory.
- How to set
 - Selecting function mode 2 -> Function enable command ON .
- Count latch stores the current count value in each time the function enable command is ON.
- The latched count value is displayed in function block(HSCB_CNT)'s LTCH_OLD.

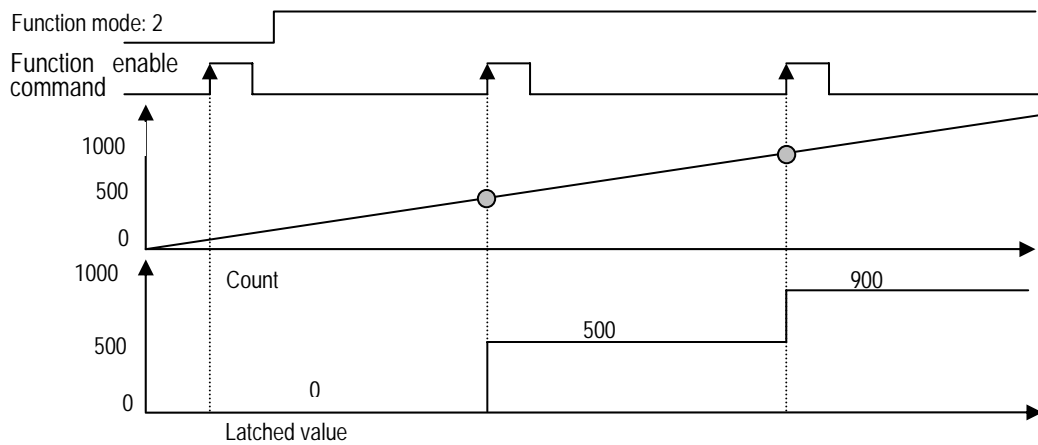

Remark

※ Function enable command : When using FB the command is AUX_E and when using the terminal after setting the supplementary function enable command(AUX_I/E in FB), Use the Gate terminal.

3) Sampling Count

- In this function, if Function enable command is ON, Count is executed during the preset sampling time and stores the value in the internal buffer memory.
- How to set
 - Selecting function mode 3 -> Function enable command ON .
- Sampling count is executed in each time the function enable command is ON.
- Sampling count value is displayed in function block(HSCB_CNT)'s SCNT_NEW.
- The signal for displaying The supplementary function run.
 - During the preset sampling time, sampling count is executed and at the same time the function run signal(HSCB_RD function block's AUX_ING) is turned ON.

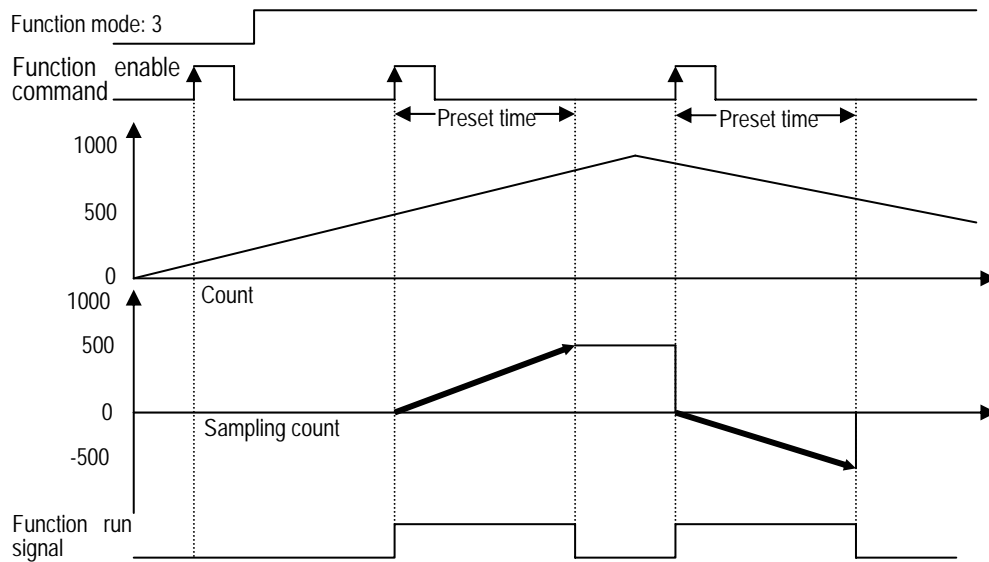

Remark

※ Function enable command : When using FB the command is AUX_E and when using the terminal after setting the supplementary function enable command(AUX_I/E in FB), Use the Gate terminal.

Chapter 2 Specifications

4) Pulse frequency count

- In this function, if Function enable command is ON, frequency count of phase A/B is executed every second and stores the value in the internal buffer memory.

- How to set

- Selecting function mode 4 -> Function enable command ON .

- During the function enable command is ON, number of the internal clock renewed every second is displayed.

- By using the renewed internal clock, frequency of each phase can be calculated as follows.

- Frequency = $\frac{25,000,000}{T}$ ※ T : Number of clock

- The signal for displaying The supplementary function run.

- During the function enable command is ON, pulse frequency count function is executed and stores the value in the internal buffer memory.

- At the same time, the function run signal is turned ON.

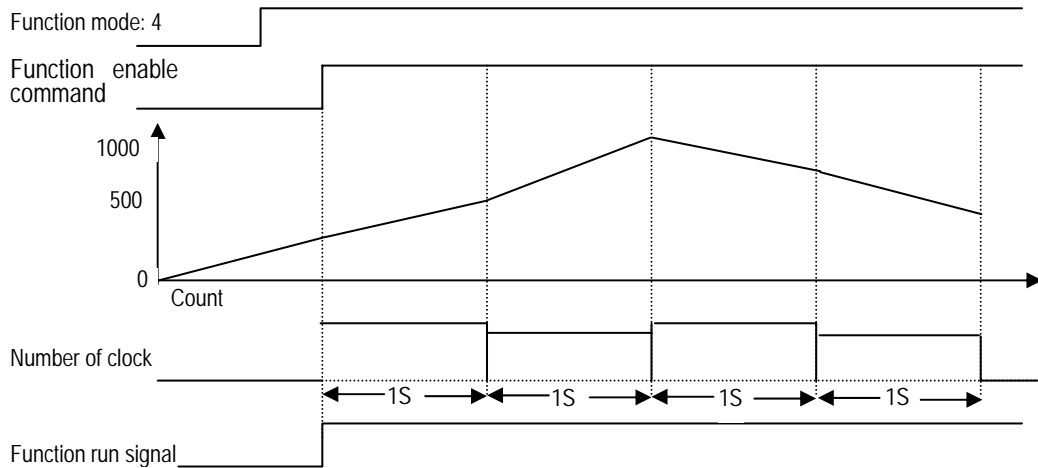

Remark

※ Function enable command : When using FB the command is AUX_E and when using the terminal after setting the supplementary function enable command(AUX_I/E in FB), Use the Gate terminal.

5) Periodic pulse count

- In this function, if Function enable command is ON, periodic pulse count is executed during the preset time and stores the value in the internal buffer memory.
- How to set
 - Selecting function mode 5 -> Setting the preset time -> Function enable command ON .
- During the function enable command is ON, number of pulse count is renewed in every the preset time.
- The renewed pulse count value is displayed on HSCB_CNT function block's SCNT_NEW and LTCH_OLD.
- By using the renewed pulse count value, the periodic pulse count value can be calculated as follows.
 - Periodic Pulse Count Value = SCNT_NEW – LTCH_OLD
- If the preset time is 1 minute, reverse per minute(RPM) can be calculated.
 - RPM (Reverse Per Minute) = $\frac{PPU}{P}$
 - ※ PPU : Number of input pulse, P : Pulse count per rotation.
- The signal for displaying The supplementary function run.
 - During the function enable command is ON, periodic pulse count function is executed and at the same time, the function run signal is turned ON.

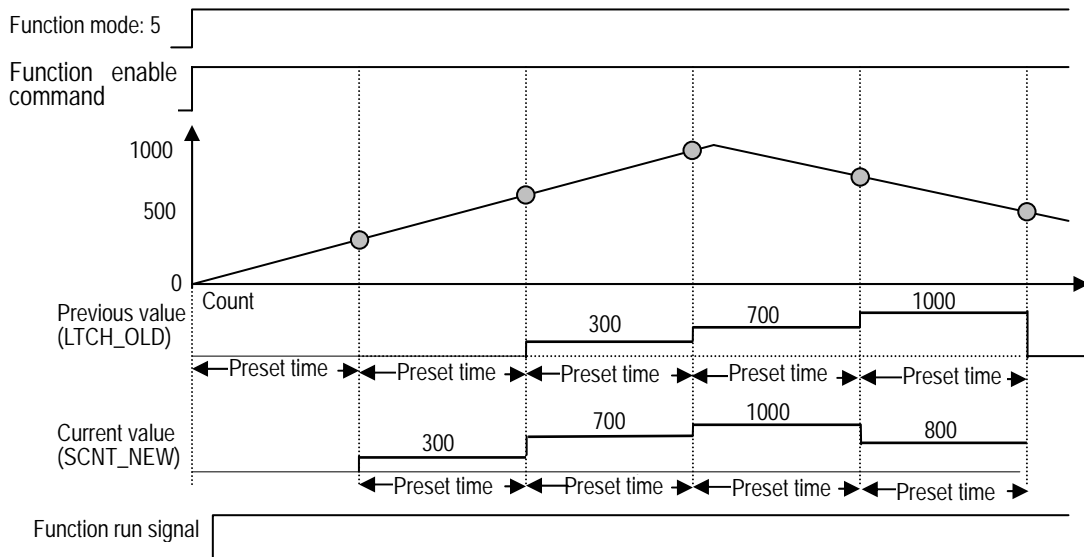

Remark

※ Function enable command : When using FB the command is AUX_E and when using the terminal after setting the supplementary function enable command(AUX_I/E in FB), Use the Gate terminal.

Chapter 3 Installation and Wiring

3.1 Installation

3.1.1 Installation Ambience

This module has high reliability regardless of its installation ambience. But be sure to check the following conditions for higher reliability and stability of the system.

1) Ambience Requirements

Avoid installing this module in places, which are subjected or exposed to:

- Water leakage and dust a large amount of dust, powder and other conductive power, oil mist, salt, of organic solvent.
- Mechanical vibrations of impacts transmitted directly to the module body.
- Direct sunlight.
- Dew condensation due to sudden temperature change.
- High or low temperatures (outside the range of 0-55 °C)

2) Installing and Wiring

- During wiring or other work, do not allow any wire scraps to enter into it.
- Install it on locations that are convenient for operation.
- Make sure that it is not located near high voltage equipment on the same panel.
- Make sure that the distance from the walls of duct and external equipment be 50 mm or more.
- Be sure to be grounded to locations that have good noise immunity.

3.1.2 Handling precautions

- 1) Do not drop or impact the product.
- 2) Do not detach PCB from the case, it may cause malfunction.
- 3) During wiring or other work, do not allow any wire chips get inside the product.
- 4) Switch the external power off before mounting or removing the module and the cable.

3.2 Wiring Precautions

When using High-speed inputs, take the following precautions against noise in wiring.

- 1) Be sure to use shielded twisted pair cables and provided class 3 grounding.
- 2) Separate a twisted pair cable from power cables or I/O line that may generate noise.
- 3) Use a stabilized power supply for pulse generator.
 - ▶ For 1-phase input, connect count-input signal only to phase A;
 - ▶ For 2-phase input, connect to phases A and B.

3.2.1 DC5V Output type encoder

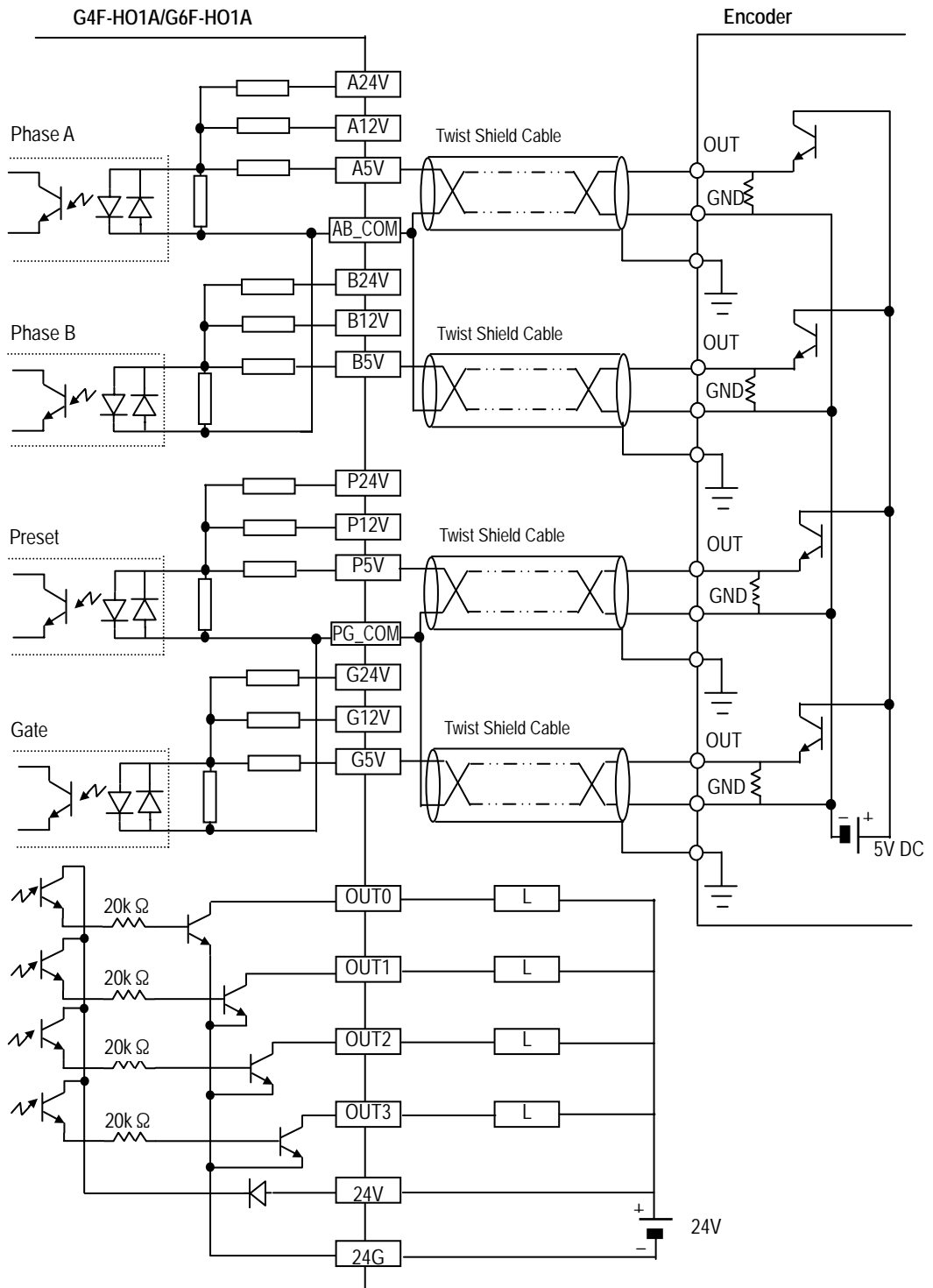

3.2.2 DC12V NPN Open collector type encoder

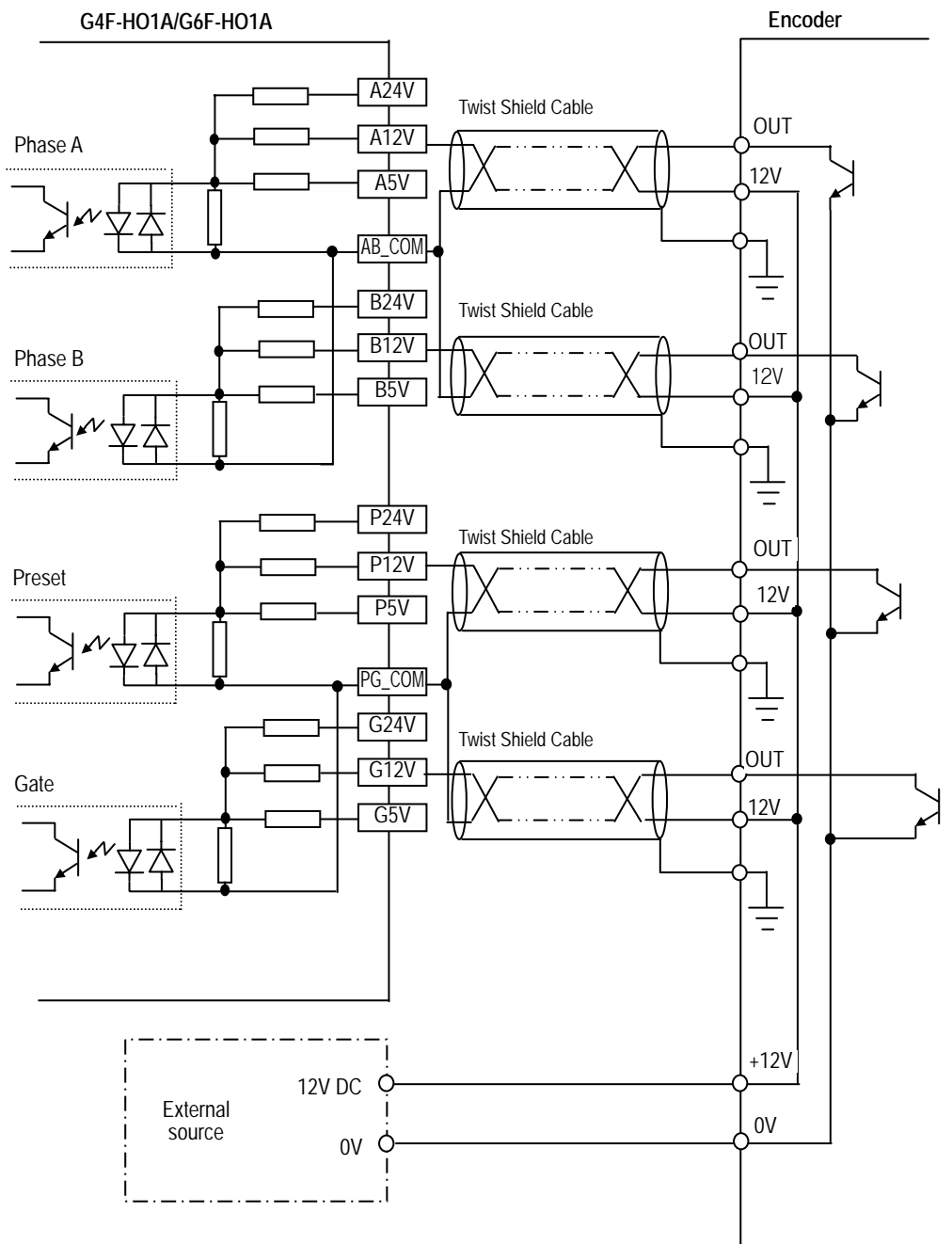

3.2.3 DC24V PNP Open collector type encoder

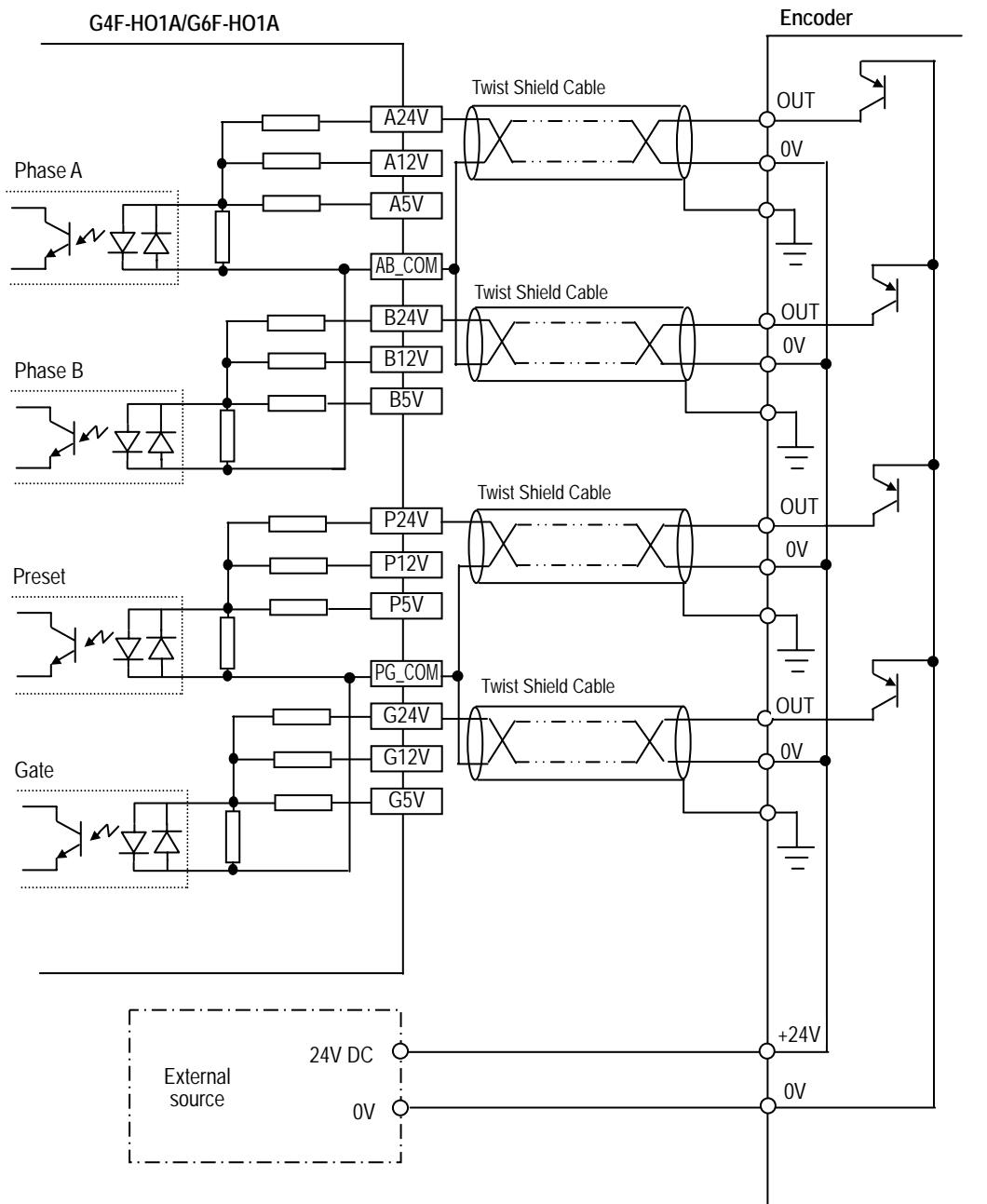

3.2.4 Line driver type encoder

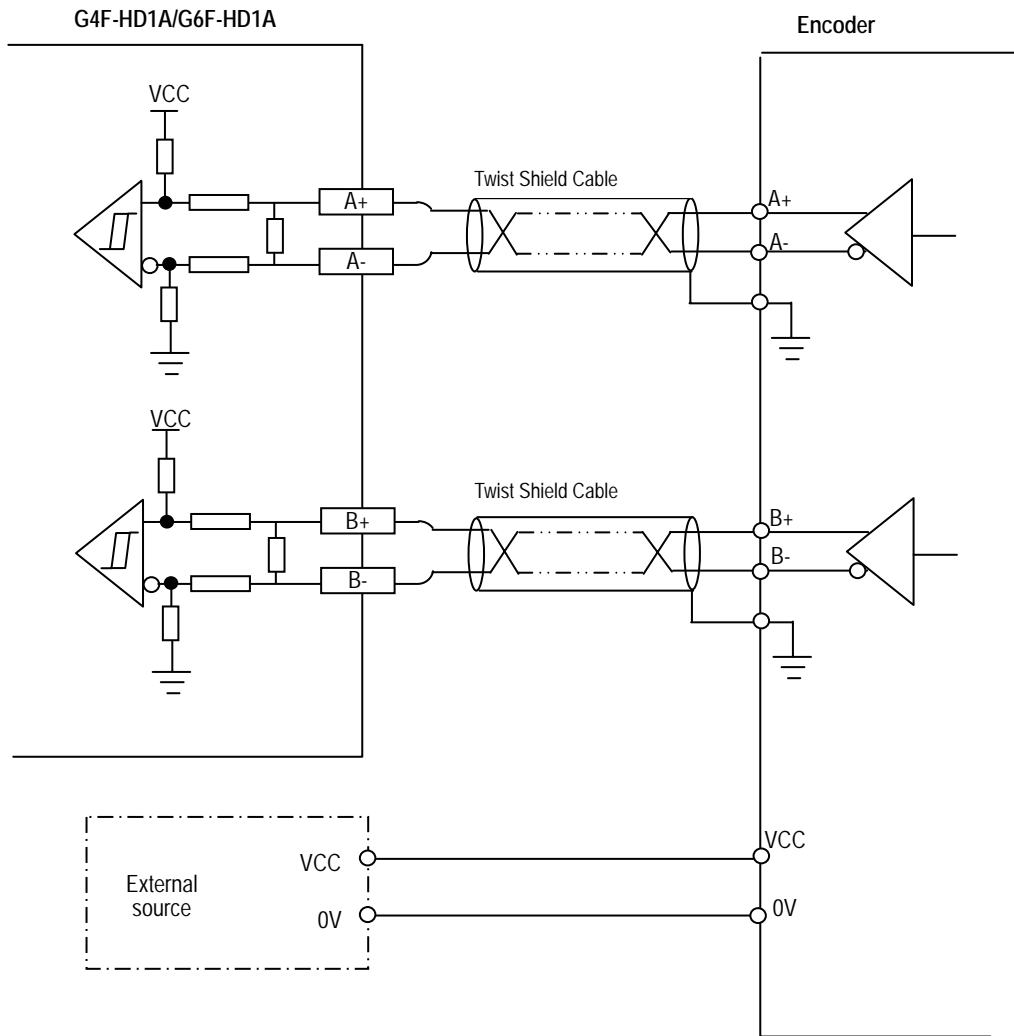

Chapter 4 Function block

■ This chapter describes function blocks for High-Speed Count Module.

No	G4F-HO1A		G6F-HO1A		Description
	G4F-HD1A		G6F-HD1A		
	Local	Remote	Local	Remote	
1	HSCB_PRE	HSCB*RPR	HSCB_PRE	HSCB*RPR	Preset setting
2	HSCB_MOD	HSCB*RMD	HSCB_MOD	HSCB*RMD	Count mode and Linear/Ring count selection
3	HSCB_AUX	HSCB*RAX	HSCB_AUX	HSCB*RAX	Function setting
4	HSCB_CMP	HSCB*RCP	HSCB_CMP	HSCB*RCP	Coincidence output setting
5	HSCB_CNT	HSCB*RCT	HSCB_CNT	HSCB*RCT	Current count value reading
6	HSCB_WR	HSCB*RWR	HSCB_WR	HSCB*RWR	Operating information writing
7	HSCB_RD	HSCB*RRD	HSCB_RD	HSCB*RRD	Operating information reading
8	HSCB_OUT	HSCB*ROT	HSCB_OUT	HSCB*ROT	Coincidence output state reading

4.1 Insertion of the Function Block on the GMWIN

Function Block is inserted on the execution of the GMWIN according to following procedure.

Project (P)



Library insertion

- G4F-HO1A, G4F-HD1A**
- 1. Special.4fb
- 2. Remote3.4fb
- 3. Remote4.4fb
- G6F-HO1A, G6F-HD1A**
- 1. Special.6fb
- 2. Remote3.6fb
- 3. Remote4.6fb
- 4. Remote6.6fb

■ GMWIN V3.62 Example

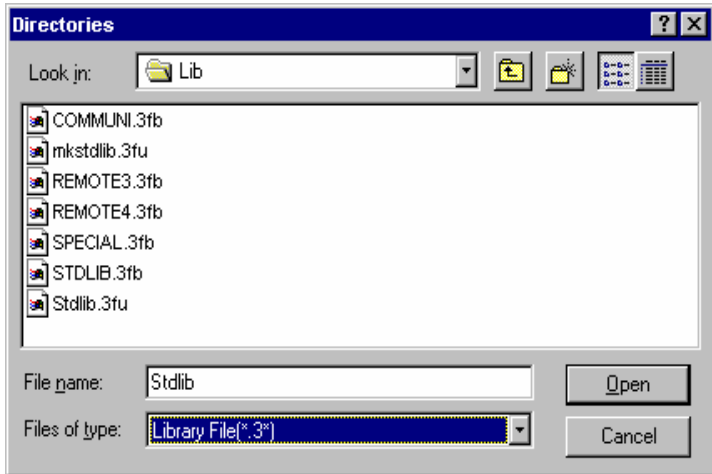

4.2 Local function block

4.2.1 Preset setting function block (HSCB_PRE)

■ This function block sets the preset value.

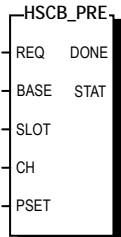
Figure	I/O	Variable name	Data type	Description
 <p>The diagram shows a rectangular function block labeled 'HSCB_PRE'. On the left side, there are five input variables: REQ, BASE, SLOT, CH, and PSET. On the right side, there are two output variables: DONE and STAT.</p>	Input	REQ	BOOL	Function block execution request. <ul style="list-style-type: none"> When this variable is turned "0→1" function block is executed.
		BASE	USINT	Base location No. <ul style="list-style-type: none"> Number of base that high-speed counter module is mounted. Range : GM4 series(0 ~ 3), GM6 series : 0
		SLOT	USINT	Slot location No. <ul style="list-style-type: none"> Number of slot that high-speed counter module is mounted. Range : 0 ~ 7
		CH	BOOL	Channel <ul style="list-style-type: none"> "0": channel 0, "1": channel 1
		PSET	DINT	Preset value <ul style="list-style-type: none"> Range : -2,147,483,648 ~ 2,147,483,647
	Output	DONE	BOOL	Function block execution signal <ul style="list-style-type: none"> If this function block is executed without error, DONE is "1" and the opposite case "0".
		STAT	USINT	Error number <ul style="list-style-type: none"> Indicates the error that occurs during execution of the function block.

4.2.2 Count mode setting function block(HSCB_MOD)

■ This function block sets the count mode and linear/ring count.

Figure	I/O	Variable name	Data type	Description																		
	Input	REQ	BOOL	Function block execution request. <ul style="list-style-type: none"> When this variable is turned "0→1" function block is executed. 																		
		BASE	USINT	Base location No. <ul style="list-style-type: none"> Number of base that high-speed counter module is mounted. Range : GM4 series(0 ~ 3), GM6 series : 0 																		
		SLOT	USINT	Slot location No. <ul style="list-style-type: none"> Number of slot that high-speed counter module is mounted. Range : 0 ~ 7 																		
		CH	BOOL	Channel <ul style="list-style-type: none"> "0": channel 0, "1": channel 1 																		
		MODE	USINT	Count mode <ul style="list-style-type: none"> Range : 0 ~ 7 <table border="1" style="margin-left: 20px;"> <thead> <tr> <th>Value</th> <th>Description</th> </tr> </thead> <tbody> <tr><td>0</td><td>2 phase multiple of 1</td></tr> <tr><td>1</td><td>2 phase multiple of 2</td></tr> <tr><td>2</td><td>2 phase multiple of 4</td></tr> <tr><td>3</td><td>CW/CCW</td></tr> <tr><td>4</td><td>1 phase multiple of 1 (up/down count by program)</td></tr> <tr><td>5</td><td>1 phase multiple of 2 (up/down count by program)</td></tr> <tr><td>6</td><td>1 phase multiple of 1 (up/down count by phase B)</td></tr> <tr><td>7</td><td>1 phase multiple of 2 (up/down count by phase B)</td></tr> </tbody> </table>	Value	Description	0	2 phase multiple of 1	1	2 phase multiple of 2	2	2 phase multiple of 4	3	CW/CCW	4	1 phase multiple of 1 (up/down count by program)	5	1 phase multiple of 2 (up/down count by program)	6	1 phase multiple of 1 (up/down count by phase B)	7	1 phase multiple of 2 (up/down count by phase B)
		Value	Description																			
		0	2 phase multiple of 1																			
		1	2 phase multiple of 2																			
	2	2 phase multiple of 4																				
	3	CW/CCW																				
4	1 phase multiple of 1 (up/down count by program)																					
5	1 phase multiple of 2 (up/down count by program)																					
6	1 phase multiple of 1 (up/down count by phase B)																					
7	1 phase multiple of 2 (up/down count by phase B)																					
SEL	BOOL	Linear / Ring count selection <ul style="list-style-type: none"> 0: Linear count 1: Ring count 																				
RING_L	DINT	User-defined minimum value of Ring count <ul style="list-style-type: none"> Range : -2,147,483,648 ~ 2,147,483,647 																				
RING_H	DINT	User-defined maximum value of Ring count <ul style="list-style-type: none"> Range: -2,147,483,648 ~ 2,147,483,647 																				
Output	DONE	BOOL	Function block execution signal <ul style="list-style-type: none"> If this function block is executed without error, DONE is "1" and the opposite case "0". 																			
	STAT	USINT	Error number <ul style="list-style-type: none"> Indicates the error that occurs during execution of the function block. 																			

4.2.3 Supplementary function setting function block (HSCB_AUX)

■ This function block sets the functions.

Figure	I/O	Variable name	Data type	Description														
	Input	REQ	BOOL	Function block execution request. <ul style="list-style-type: none"> When this variable is turned "0→1" function block is executed. 														
		BASE	USINT	Base location No. <ul style="list-style-type: none"> Number of base that high-speed counter module is mounted. Range : GM4 series(0 ~ 3), GM6 series : 0 														
		SLOT	USINT	Slot location No. <ul style="list-style-type: none"> Number of slot that high-speed counter module is mounted. Range : 0 ~ 7 														
		CH	BOOL	Channel <ul style="list-style-type: none"> "0": channel 0, "1": channel 1 														
		AUX	USINT	Function selection <ul style="list-style-type: none"> Range : 0 ~ 5 <table border="1" style="margin-left: 20px;"> <thead> <tr> <th>Value</th> <th>Description</th> </tr> </thead> <tbody> <tr> <td>0</td> <td>-</td> </tr> <tr> <td>1</td> <td>Count clear function</td> </tr> <tr> <td>2</td> <td>Count latch function</td> </tr> <tr> <td>3</td> <td>Sampling count function</td> </tr> <tr> <td>4</td> <td>Pulse frequency count function</td> </tr> <tr> <td>5</td> <td>Periodic pulse count function</td> </tr> </tbody> </table>	Value	Description	0	-	1	Count clear function	2	Count latch function	3	Sampling count function	4	Pulse frequency count function	5	Periodic pulse count function
		Value	Description															
	0	-																
	1	Count clear function																
2	Count latch function																	
3	Sampling count function																	
4	Pulse frequency count function																	
5	Periodic pulse count function																	
SET_TIME	UINT	Preset time for sampling count function. <ul style="list-style-type: none"> Range : 1 ~ 65,535 (ms) Preset time for periodic pulse count function. <ul style="list-style-type: none"> Range : 1 ~ 65,535 (ms) 																
Output	DONE	BOOL	Function block execution signal <ul style="list-style-type: none"> If this function block is executed without error, DONE is "1" and the opposite case "0". 															
	STAT	USINT	Error number <ul style="list-style-type: none"> Indicates the error that occurs during execution of the function block. 															

4.2.4 Coincidence output setting function block (HSCB_CMP)

■ This function block sets the coincidence output conditions and values.

Figure	I/O	Variable name	Data type	Description																								
<p>The diagram shows the HSCB_CMP function block with the following variables:</p> <ul style="list-style-type: none"> Input: REQ, BASE, SLOT, CH, CMPS, CMPL, CMPH Output: DONE, STAT 	Input	REQ	BOOL	Function block execution request. <ul style="list-style-type: none"> When this variable is turned "0→1" function block is executed. 																								
		BASE	USINT	Base location No. <ul style="list-style-type: none"> Number of base that high-speed counter module is mounted. Range : GM4 series(0 ~ 3), GM6 series : 0 																								
		SLOT	USINT	Slot location No. <ul style="list-style-type: none"> Number of slot that high-speed counter module is mounted. Range : 0 ~ 7 																								
		CH	BOOL	Channel <ul style="list-style-type: none"> "0": channel 0, "1": channel 1 																								
		CMPS	USINT [Array] *1	Coincidence output selection <ul style="list-style-type: none"> Range : 0 ~ 6 <table border="1" style="margin-left: 20px;"> <thead> <tr> <th>Value</th> <th>Symbol</th> <th>Description</th> </tr> </thead> <tbody> <tr> <td>0</td> <td><</td> <td>Less than</td> </tr> <tr> <td>1</td> <td>≤</td> <td>Equal or less than</td> </tr> <tr> <td>2</td> <td>=</td> <td>Equal</td> </tr> <tr> <td>3</td> <td>≥</td> <td>Equal or more than</td> </tr> <tr> <td>4</td> <td>></td> <td>More than</td> </tr> <tr> <td>5</td> <td>≤ ≤</td> <td>Including (for a section)</td> </tr> <tr> <td>6</td> <td>≥ ≤</td> <td>Not including (for a section)</td> </tr> </tbody> </table>	Value	Symbol	Description	0	<	Less than	1	≤	Equal or less than	2	=	Equal	3	≥	Equal or more than	4	>	More than	5	≤ ≤	Including (for a section)	6	≥ ≤	Not including (for a section)
		Value	Symbol	Description																								
		0	<	Less than																								
	1	≤	Equal or less than																									
	2	=	Equal																									
	3	≥	Equal or more than																									
4	>	More than																										
5	≤ ≤	Including (for a section)																										
6	≥ ≤	Not including (for a section)																										
CMPL	DINT [Array] *1	Compared value for coincidence output selection 0~4 or User-defined minimum value for selection 5-6. <ul style="list-style-type: none"> Range: -2,147,483,648 ~ 2,147,483,647 																										
CMPH	DINT [Array] *1	User-defined maximum value for selection 5-6. <ul style="list-style-type: none"> Range: -2,147,483,648 ~ 2,147,483,647 																										
Output	DONE	BOOL	Function block execution signal <ul style="list-style-type: none"> If this function block is executed without error, DONE is "1" and the opposite case "0". 																									
	STAT	USINT	Error number <ul style="list-style-type: none"> Indicates the error that occurs during execution of the function block. 																									

Remark

※ 1 : Number of array is 4.

4.2.5 Count reading function block (HSCB_CNT)

■ This function block reads the count value of the current and the function count.

Figure	I/O	Variable name	Data type	Description
<div style="border: 1px solid black; padding: 5px; width: fit-content;"> <p>HSCB_CNT</p> <p>REQ DONE</p> <p>BASE STAT</p> <p>SLOT CNT</p> <p>CH LTCH_OLD</p> <p> SCNT_NEW</p> <p> TIME_A</p> <p> TIME_B</p> </div>	Input	REQ	BOOL	Function block execution request. ● When this variable is turned "0→1" function block is executed.
		BASE	USINT	Base location No. ● Number of base that high-speed counter module is mounted. ● Range : GM4 series(0 ~ 3), GM6 series : 0
		SLOT	USINT	Slot location No. ● Number of slot that high-speed counter module is mounted. ● Range : 0 ~ 7
		CH	BOOL	Channel. ● "0": channel 0, "1": channel 1
	Output	DONE	BOOL	Function block execution signal ● If this function block is executed without error, DONE is "1" and the opposite case "0".
		STAT	USINT	Error number. ● Indicates the error that occurs during execution of the function block.
		CNT	DINT	Current count value. ● Range : -2,147,483,648 ~ 2,147,483,647
		LTCH_OLD	DINT	Latched count value ● Range: -2,147,483,648 ~ 2,147,483,647
				Previous count values for periodic pulse count function. ● Range: -2,147,483,648 ~ 2,147,483,647
		SCNT_NEW	DINT	Sampling count value ● Range : 0 ~ -2,147,483,648 or 0 ~ +2,147,483,647
				Current count values for periodic pulse count function. ● Range : -2,147,483,648 ~ 2,147,483,647
		TIME_A	UDINT	Number of phase A clock for pulse frequency count function. ● Range : 1 ~ 25,000,000 (EA)
TIME_B	UDINT	Number of phase B clock for pulse frequency counts function. ● Range : 1 ~ 25,000,000 (EA)		

4.2.6 Operating information writing function block(HSCB_WR)

■ This function block writes Count enable command, Preset enable command, Up/down count enable command, Gate enable command etc to PLC.

Figure	I/O	Variable name	Data type	Description
	Input	REQ	BOOL	Function block execution request. ● When this variable is turned "0→1" function block is executed.
		BASE	USINT	Base location No. ● Number of base that high-speed counter module is mounted. ● Range : GM4 series(0 ~ 3), GM6 series : 0
		SLOT	USINT	Slot location No. ● Number of slot that high-speed counter module is mounted. ● Range : 0 ~ 7
		CH	BOOL	Channel. ● "0": channel 0, "1": channel 1
		CNT_E	BOOL	Count enable command ● "0": count enable. ● "1": count disable.
		PRE_E	BOOL	Preset enable command ● "0": preset disable. ● "1": preset enable.
		DOWN	BOOL	Up/down count enable by program ● "0": up count. ● "1": down count.
		AUX_E	BOOL	Function enable command. ● "0": function disable ● "1": function enable.
		CY_R	BOOL	Carry/ Borrow reset command. ● "0": carry / borrow state is retained. ● "1": carry / borrow is reset.
		PRE_I/E	BOOL	Preset enable method selection (program or terminal input) ● "0": preset enable by program. ● "1": preset enable by terminal input.
		AUX_I/E	BOOL	Function enable method selection (program or terminal input) ● "0": preset enable by program. ● "1": preset enable by terminal input
		PRE_R	BOOL	Preset flag (occurred by terminal input) reset command ● "0": preset flag is retained. ● "1": preset flag is reset.
		AUX_R	BOOL	Function flag (occurred by terminal input) reset command ● "0": preset flag is retained. ● "1": preset flag is reset.
		Output	DONE	BOOL
		STAT	USINT	Error number. ● Indicates the error that occurs during execution of the function block.

4.2.7 Operating information reading function block (HSCB_RD)

■ This function block reads Carry, Borrow, Preset flag, Function flag etc from PLC.

Figure	I/O	Variable name	Data type	Description
	Input	REQ	BOOL	Function block execution request. ● When this variable is turned "0→1" function block is executed.
		BASE	USINT	Base location No. ● Number of base that high-speed counter module is mounted. ● Range : GM4 series(0 ~ 3), GM6 series : 0
		SLOT	USINT	Slot location No. ● Number of slot that high-speed counter module is mounted. ● Range : 0 ~ 7
		CH	BOOL	Channel. ● "0": channel 0, "1": channel 1
	Output	DONE	BOOL	Function block execution signal ● If this function block is executed without error, DONE is "1" and the opposite case "0".
		STAT	USINT	Error number. ● Indicates the error that occurs during execution of the function block.
		DOWN_F	BOOL	Up/down count flag ● "0": up count ● "1": down count
		PRE_F	BOOL	Preset flag (occurred by terminal input) ● "0": preset input is OFF (by terminal input) ● "1": preset input is OFF (by terminal input)
		AUX_F	BOOL	Function flag (occurred by terminal input) ● "0": function input is OFF (by terminal input) ● "1": function input is OFF (by terminal input)
		CY	BOOL	Carry ● "0": no carry occurred. ● "1": carry occurred.
		BW	BOOL	Borrow ● "0": no borrow occurred. ● "1": borrow occurred.
		AUX_ING	BOOL	Function run signal ● "0": function OFF. ● "1": function ON.

4.2.8 Coincidence output function block(HSCB_OUT)

■ This function block writes Coincidence output enable command, Comparing enable command to PLC and reads coincidence output state from PLC.

Figure	I/O	Variable name	Data type	Description
	Input	REQ	BOOL	Function block execution request. ● When this variable is turned "0→1" function block is executed.
		BASE	USINT	Base location No. ● Number of base that high-speed counter module is mounted. ● Range : GM4 series(0 ~ 3), GM6 series : 0
		SLOT	USINT	Slot location No. ● Number of slot that high-speed counter module is mounted. ● Range : 0 ~ 7
		CH	BOOL	Channel. ● "0": channel 0, "1": channel 1
		CMP_E	BOOL	Comparing enable command. ● "0": comparison disable. ● "1": comparison enable.
		OUT_E	BOOL	Coincidence output enable command. ● "0": coincidence output disable of OUT0/OUT1/OUT2/OUT3 ● "1": coincidence output enable of OUT0/OUT1/OUT2/OUT3
		EQ0_R	BOOL	Coincidence output (occurred by "equal") reset command for OUT0. ● "1": coincidence output occurred by "equal" is reset.
		EQ1_R	BOOL	Coincidence output (occurred by "equal") reset command for OUT1. ● "1": coincidence output occurred by "equal" is reset.
		EQ2_R	BOOL	Coincidence output (occurred by "equal") reset command for OUT2. ● "1": coincidence output occurred by "equal" is reset.
		EQ3_R	BOOL	Coincidence output (occurred by "equal") reset command for OUT3. ● "1": coincidence output occurred by "equal" is reset.
	Output	DONE	BOOL	Function block execution signal ● If this function block is executed without error, DONE is "1" and the opposite case "0".
		STAT	USINT	Error number. ● Indicates the error that occurs during execution of the function block.
		OUT0	BOOL	Coincidence output state of OUT0. ● "0": coincidence output of OUT0 is OFF. ● "1": coincidence output of OUT0 is ON.
		OUT1	BOOL	Coincidence output state of OUT1. ● "0": coincidence output of OUT1 is OFF. ● "1": coincidence output of OUT1 is ON.
		OUT2	BOOL	Coincidence output state of OUT2. ● "0": coincidence output of OUT2 is OFF. ● "1": coincidence output of OUT2 is ON.
		OUT3	BOOL	Coincidence output state of OUT3. ● "0": coincidence output of OUT3 is OFF. ● "1": coincidence output of OUT3 is ON.

4.3 Remote function block

4.3.1 Preset setting function block (HSCB*RPR)

■ This function block sets the preset value.

Figure	I/O	Variable name	Data type	Description
<p>The diagram shows a function block labeled HSCB*RPR. On the left side, there are seven input terminals: REQ, NET_NO, ST_NO, BASE, SLOT, CH, and PSET. On the right side, there are three output terminals: DONE, ERR, and STAT.</p>	Input	REQ	BOOL	Function block execution request. ● When this variable is turned "0→1" function block is executed.
		NET_NO	USINT	Stat No. (0 ~ 7) of the local communication modules (G3L – FUEA, G4L – FUEA, G3L – FUOA) are mounted. ● Range : 0 ~ 7
		ST_NO	USINT	Station No. (0 ~ 63) of the communication modules (G3L – RBEA, G4L – RBOA, G4L – BBEA) mounted on the remote I/O station. ● Range : 0 ~ 63
		BASE	USINT	Base location No. ● Number of base that high-speed counter module is mounted. ● Range : GM4 series(0 ~ 3), GM6 series : 0
		SLOT	USINT	Slot location No. ● Number of slot that high-speed counter module is mounted. ● Range : 0 ~ 7
		CH	BOOL	Channel. ● "0": channel 0, "1": channel 1
		PSET	DINT	Preset value ● Range : -2,147,483,648 ~ 2,147,483,647
	Output	DONE	BOOL	Function block execution signal ● If this function block is executed without error, DONE is "1" and the opposite case "0".
		ERR	BOOL	Error state of function block execution ● Turns ON If error occurs during the execution of the function block
		STAT	USINT	Error number. ● Indicates the error that occurs during execution of the function block.

4.3.2 Count mode setting function block (HSCB*RMD)

■ This function block sets the count mode and linear/ring count.

Figure	I/O	Variable name	Data type	Description																			
	Input	REQ	BOOL	Function block execution request. ● When this variable is turned "0→1" function block is executed.																			
		NET_NO	USINT	Slot No. (0 ~ 7) of the local communication modules (G3L – FUEA, G4L – FUEA, G3L – FUOA) are mounted. ● Range : 0 ~ 7																			
		ST_NO	USINT	Station No. (0 ~ 63) of the communication modules (G3L – RBEA, G4L – RBOA, G4L – BBEA) mounted on the remote I/O station. ● Range : 0 ~ 63																			
		BASE	USINT	Base location No. ● Number of base that high-speed counter module is mounted. ● Range : GM4 series(0 ~ 3), GM6 series : 0																			
		SLOT	USINT	Slot location No. ● Number of slot that high-speed counter module is mounted. ● Range : 0 ~ 7																			
		CH	BOOL	Channel. ● "0": channel 0, "1": channel 1																			
		MODE	USINT	Count mode ● Range : 0 ~ 7	<table border="1"> <thead> <tr> <th>Value</th> <th>Description</th> </tr> </thead> <tbody> <tr> <td>0</td> <td>2 phase multiple of 1</td> </tr> <tr> <td>1</td> <td>2 phase multiple of 2</td> </tr> <tr> <td>2</td> <td>2 phase multiple of 4</td> </tr> <tr> <td>3</td> <td>CW/CCW</td> </tr> <tr> <td>4</td> <td>1 phase multiple of 1 (up/down count by program)</td> </tr> <tr> <td>5</td> <td>1 phase multiple of 2 (up/down count by program)</td> </tr> <tr> <td>6</td> <td>1 phase multiple of 1 (up/down count by phase B)</td> </tr> <tr> <td>7</td> <td>1 phase multiple of 2 (up/down count by phase B)</td> </tr> </tbody> </table>	Value	Description	0	2 phase multiple of 1	1	2 phase multiple of 2	2	2 phase multiple of 4	3	CW/CCW	4	1 phase multiple of 1 (up/down count by program)	5	1 phase multiple of 2 (up/down count by program)	6	1 phase multiple of 1 (up/down count by phase B)	7	1 phase multiple of 2 (up/down count by phase B)
		Value	Description																				
		0	2 phase multiple of 1																				
		1	2 phase multiple of 2																				
	2	2 phase multiple of 4																					
	3	CW/CCW																					
	4	1 phase multiple of 1 (up/down count by program)																					
5	1 phase multiple of 2 (up/down count by program)																						
6	1 phase multiple of 1 (up/down count by phase B)																						
7	1 phase multiple of 2 (up/down count by phase B)																						
SEL	BOOL	Linear / Ring count selection ● 0: Linear count ● 1: Ring count																					
RING_L	DINT	User-defined minimum value of Ring count ● Range : -2,147,483,648 ~ 2,147,483,647																					
RING_H	DINT	User-defined maximum value of Ring count ● Range: -2,147,483,648 ~ 2,147,483,647																					
Output	DONE	BOOL	Function block execution signal ● If this function block is executed without error, DONE is "1" and the opposite case "0".																				
	ERR	BOOL	Error state of function block execution ● Turns ON If error occurs during the execution of the function block																				
	STAT	USINT	Error number. ● Indicates the error that occurs during execution of the function block.																				

4.3.3 Function setting function block (HSCB*RAX)

■ This function block sets the functions.

Figure	I/O	Variable name	Data type	Description													
	Input	REQ	BOOL	Function block execution request. <ul style="list-style-type: none"> When this variable is turned "0→1" function block is executed. 													
		NET_NO	USINT	Slot No. (0 ~ 7) of the local communication modules (G3L – FUEA, G4L – FUEA, G3L – FUOA) are mounted. <ul style="list-style-type: none"> Range : 0 ~ 7 													
		ST_NO	USINT	Station No. (0 ~ 63) of the communication modules (G3L – RBEA, G4L – RBOA, G4L – BBEA) mounted on the remote I/O station. <ul style="list-style-type: none"> Range : 0 ~ 63 													
		BASE	USINT	Base location No. <ul style="list-style-type: none"> Number of base that high-speed counter module is mounted. Range : GM4 series(0 ~ 3), GM6 series : 0 													
		SLOT	USINT	Slot location No. <ul style="list-style-type: none"> Number of slot that high-speed counter module is mounted. Range : 0 ~ 7 													
		CH	BOOL	Channel. <ul style="list-style-type: none"> "0": channel 0, "1": channel 1 													
		AUX	USINT	Function selection <ul style="list-style-type: none"> Range : 0 ~ 5 <table border="1" style="margin-left: 20px;"> <thead> <tr> <th>Value</th> <th>Description</th> </tr> </thead> <tbody> <tr> <td>0</td> <td>-</td> </tr> <tr> <td>1</td> <td>Count clear function</td> </tr> <tr> <td>2</td> <td>Count latch function</td> </tr> <tr> <td>3</td> <td>Sampling count function</td> </tr> <tr> <td>4</td> <td>Pulse frequency count function</td> </tr> <tr> <td>5</td> <td>Periodic pulse count function</td> </tr> </tbody> </table>	Value	Description	0	-	1	Count clear function	2	Count latch function	3	Sampling count function	4	Pulse frequency count function	5
	Value	Description															
	0	-															
	1	Count clear function															
2	Count latch function																
3	Sampling count function																
4	Pulse frequency count function																
5	Periodic pulse count function																
SET_TIME	UINT	Preset time for sampling count function. <ul style="list-style-type: none"> Range : 1 ~ 65,535 (ms) Preset time for periodic pulse count function. <ul style="list-style-type: none"> Range : 1 ~ 65,535 (ms) 															
Output	DONE	BOOL	Function block execution signal <ul style="list-style-type: none"> If this function block is executed without error, DONE is "1" and the opposite case "0". 														
	ERR	BOOL	Error state of function block execution <ul style="list-style-type: none"> Turns ON If error occurs during the execution of the function block 														
	STAT	USINT	Error number. <ul style="list-style-type: none"> Indicates the error that occurs during execution of the function block. 														

4.3.4 Coincidence output setting function block (HSCB*RCP)

■ This function block sets the coincidence output conditions and values.

Figure	I/O	Variable name	Data type	Description																									
	Input	REQ	BOOL	Function block execution request. ● When this variable is turned "0→1" function block is executed.																									
		NET_NO	USINT	Slot No. (0 ~ 7) of the local communication modules (G3L – FUEA, G4L – FUEA, G3L – FUOA) are mounted. ● Range : 0 ~ 7																									
		ST_NO	USINT	Station No. (0 ~ 63) of the communication modules (G3L – RBEA, G4L – RBOA, G4L – BBEA) mounted on the remote I/O station. ● Range : 0 ~ 63																									
		BASE	USINT	Base location No. ● Number of base that high-speed counter module is mounted. ● Range : GM4 series(0 ~ 3), GM6 series : 0																									
		SLOT	USINT	Slot location No. ● Number of slot that high-speed counter module is mounted. ● Range : 0 ~ 7																									
		CH	BOOL	Channel. ● "0": channel 0, "1": channel 1																									
		CMPS	USINT [Array] *1	Coincidence output selection ● Range : 0 ~ 6	<table border="1"> <thead> <tr> <th>Value</th> <th>Symbol</th> <th>Description</th> </tr> </thead> <tbody> <tr> <td>0</td> <td><</td> <td>Less than</td> </tr> <tr> <td>1</td> <td>≤</td> <td>Equal or less than</td> </tr> <tr> <td>2</td> <td>=</td> <td>Equal</td> </tr> <tr> <td>3</td> <td>≥</td> <td>Equal or more than</td> </tr> <tr> <td>4</td> <td>></td> <td>More than</td> </tr> <tr> <td>5</td> <td>≤</td> <td>Including (for a section)</td> </tr> <tr> <td>6</td> <td>≥ ≤</td> <td>Not including (for a section)</td> </tr> </tbody> </table>	Value	Symbol	Description	0	<	Less than	1	≤	Equal or less than	2	=	Equal	3	≥	Equal or more than	4	>	More than	5	≤	Including (for a section)	6	≥ ≤	Not including (for a section)
		Value	Symbol	Description																									
		0	<	Less than																									
		1	≤	Equal or less than																									
	2	=	Equal																										
	3	≥	Equal or more than																										
	4	>	More than																										
5	≤	Including (for a section)																											
6	≥ ≤	Not including (for a section)																											
CMPL	DINT [Array] *1	Compared value for coincidence output selection 0~4 or User-defined minimum value for selection 5-6. ● Range: -2,147,483,648 ~ 2,147,483,647																											
CMPH	DINT [Array] *1	User-defined maximum value for selection 5-6. ● Range: -2,147,483,648 ~ 2,147,483,647																											
Output	DONE	BOOL	Function block execution signal ● If this function block is executed without error, DONE is "1" and the opposite case "0".																										
	ERR	BOOL	Error state of function block execution ● Turns ON If error occurs during the execution of the function block																										
	STAT	USINT	Error number. ● Indicates the error that occurs during execution of the function block.																										

Remark

※ 1 : Number of array is 4.

4.3.5 Count reading function block (HSCB*RCT)

■ This function block reads the count value of the current and the function count.

Figure	I/O	Variable name	Data type	Description
	Input	REQ	BOOL	Function block execution request. ● When this variable is turned "0→1" function block is executed.
		NET_NO	USINT	Slot No. (0 ~ 7) of the local communication modules (G3L – FUEA, G4L – FUEA, G3L – FUOA) are mounted. ● Range : 0 ~ 7
		ST_NO	USINT	Station No. (0 ~ 63) of the communication modules (G3L – RBEA, G4L – RBOA, G4L – BBEA) mounted on the remote I/O station. ● Range : 0 ~ 63
		BASE	USINT	Base location No. ● Number of base that high-speed counter module is mounted. ● Range : GM4 series(0 ~ 3), GM6 series : 0
		SLOT	USINT	Slot location No. ● Number of slot that high-speed counter module is mounted. ● Range : 0 ~ 7
		CH	BOOL	Channel. ● "0": channel 0, "1": channel 1
	Output	DONE	BOOL	Function block execution signal ● If this function block is executed without error, DONE is "1" and the opposite case "0".
		ERR	BOOL	Error state of function block execution ● Turns ON If error occurs during the execution of the function block
		STAT	USINT	Error number. ● Indicates the error that occurs during execution of the function block.
		CNT	DINT	Current count value. ● Range : -2,147,483,648 ~ 2,147,483,647
		LTCH_OL D	DINT	Latched count value ● Range : -2,147,483,648 ~ 2,147,483,647
				Previous count values for periodic pulse count function. ● Range : -2,147,483,648 ~ 2,147,483,647
		SCNT_NE W	DINT	Sampling count value ● Range : 0 ~ -2,147,483,648 or 0 ~ +2,147,483,647
Current count values for periodic pulse count function. ● Range : -2,147,483,648 ~ 2,147,483,647				
TIME_A	UDINT	Number of phase A clock for pulse frequency count function. ● Range : 1 ~ 25,000,000 (EA)		
TIME_B	UDINT	Number of phase B clock for pulse frequency counts function. ● Range : 1 ~ 25,000,000 (EA)		

4.3.6 Operating information writing function block(HSCB*RWR)

■ This function block writes Count enable command, Preset enable command, Up/down count enable command, Gate enable command etc to PLC.

Figure	I/O	Variable name	Data type	Description
	Input	REQ	BOOL	Function block execution request. ● When this variable is turned "0→1" function block is executed.
		NET_NO	USINT	Slot No. (0 ~ 7) of the local communication modules (G3L – FUEA, G4L – FUEA, G3L – FUOA) are mounted. ● Range : 0 ~ 7
		ST_NO	USINT	Station No. (0 ~ 63) of the communication modules (G3L – RBEA, G4L – RBOA, G4L – BBEA) mounted on the remote I/O station. ● Range : 0 ~ 63
		BASE	USINT	Base location No. ● Number of base that high-speed counter module is mounted. ● Range : GM4 series(0 ~ 3), GM6 series : 0
		SLOT	USINT	Slot location No. ● Number of slot that high-speed counter module is mounted. ● Range : 0 ~ 7
		CH	BOOL	Channel. ● "0": channel 0, "1": channel 1
		CNT_E	BOOL	Count enable command ● "0": count enable. ● "1": count disable.
		PRE_E	BOOL	Preset enable command ● "0": preset disable. ● "1": preset enable.
		DOWN	BOOL	Up/down count enable by program ● "0": up count. ● "1": down count.
		AUX_E	BOOL	Function enable command. ● "0": function disable ● "1": function enable.
		CY_R	BOOL	Carry/ Borrow reset command. ● "0": carry / borrow state is retained. ● "1": carry / borrow is reset.
		PRE_I/E	BOOL	Preset enable method selection (program or terminal input) ● "0": preset enable by program. ● "1": preset enable by terminal input.
		AUX_I/E	BOOL	Function enable method selection (program or terminal input) ● "0": preset enable by program. ● "1": preset enable by terminal input
		PRE_R	BOOL	Preset flag (occurred by terminal input) reset command ● "0": preset flag is retained. ● "1": preset flag is reset.
	AUX_R	BOOL	Function flag (occurred by terminal input) reset command ● "0": preset flag is retained. ● "1": preset flag is reset.	
	Output	DONE	BOOL	Function block execution signal ● If this function block is executed without error, DONE is "1" and the opposite case "0".
	ERR	BOOL	Error state of function block execution ● Turns ON If error occurs during the execution of the function block	
	STAT	USINT	Error number. ● Indicates the error that occurs during execution of the function block.	

4.3.7 Operating information reading function block (HSCB*RRD)

■ This function block reads Carry, Borrow, Preset flag, Function flag etc from PLC.

Figure	I/O	Variable name	Data type	Description
	Input	REQ	BOOL	Function block execution request. ● When this variable is turned "0→1" function block is executed.
		NET_NO	USINT	Slot No. (0 ~ 7) of the local communication modules (G3L – FUEA, G4L – FUEA, G3L – FUOA) are mounted. ● Range : 0 ~ 7
		ST_NO	USINT	Station No. (0 ~ 63) of the communication modules (G3L – RBEA, G4L – RBOA, G4L – BBEA) mounted on the remote I/O station. ● Range : 0 ~ 63
		BASE	USINT	Base location No. ● Number of base that high-speed counter module is mounted. ● Range : GM4 series(0 ~ 3), GM6 series : 0
		SLOT	USINT	Slot location No. ● Number of slot that high-speed counter module is mounted. ● Range : 0 ~ 7
		CH	BOOL	Channel. ● "0": channel 0, "1": channel 1
	Output	DONE	BOOL	Function block execution signal ● If this function block is executed without error, DONE is "1" and the opposite case "0".
		ERR	BOOL	Error state of function block execution ● Turns ON If error occurs during the execution of the function block
		STAT	USINT	Error number. ● Indicates the error that occurs during execution of the function block.
		DOWN_F	BOOL	Up/down count flag ● "0": up count ● "1": down count
		PRE_F	BOOL	Preset flag (occurred by terminal input) ● "0": preset input is OFF (by terminal input) ● "1": preset input is OFF (by terminal input)
		AUX_F	BOOL	Function flag (occurred by terminal input) ● "0": function input is OFF (by terminal input) ● "1": function input is OFF (by terminal input)
		CY	BOOL	Carry ● "0": no carry occurred. ● "1": carry occurred.
		BW	BOOL	Borrow ● "0": no borrow occurred. ● "1": borrow occurred.
AUX_ING	BOOL	Function run signal ● "0": function OFF. ● "1": function ON.		

4.3.8 Coincidence output function block(HSCB*ROT)

■ This function block writes Coincidence output enable command, Comparing enable command to PLC and reads coincidence output state from PLC..

Figure	I/O	Variable name	Data type	Description	
	Input	REQ	BOOL	Function block execution request. ● When this variable is turned "0→1" function block is executed.	
		NET_NO	USINT	Slot No. (0 ~ 7) of the local communication modules (G3L – FUEA, G4L – FUEA, G3L – FUOA) are mounted. ● Range : 0 ~ 7	
		ST_NO	USINT	Station No. (0 ~ 63) of the communication modules (G3L – RBEA, G4L – RBOA, G4L – BBEA) mounted on the remote I/O station. ● Range : 0 ~ 63	
		BASE	USINT	Base location No. ● Number of base that high-speed counter module is mounted. ● Range : GM4 series(0 ~ 3), GM6 series : 0	
		SLOT	USINT	Slot location No. ● Number of slot that high-speed counter module is mounted. ● Range : 0 ~ 7	
		CH	BOOL	Channel. ● "0": channel 0, "1": channel 1	
		CMP_E	BOOL	Comparing enable command. ● "0": comparison disable. ● "1": comparison enable.	
		OUT_E	BOOL	Coincidence output enable command. ● "0": coincidence output disable of OUT0/OUT1/OUT2/OUT3 ● "1": coincidence output enable of OUT0/OUT1/OUT2/OUT3	
		EQ0R	BOOL	Coincidence output (occurred by "equal") reset command for OUT0. ● "1": coincidence output occurred by "equal" is reset.	
		EQ1R	BOOL	Coincidence output (occurred by "equal") reset command for OUT1. ● "1": coincidence output occurred by "equal" is reset.	
		EQ2R	BOOL	Coincidence output (occurred by "equal") reset command for OUT2. ● "1": coincidence output occurred by "equal" is reset.	
		EQ3R	BOOL	Coincidence output (occurred by "equal") reset command for OUT3. ● "1": coincidence output occurred by "equal" is reset.	
		Output	DONE	BOOL	Function block execution signal ● If this function block is executed without error, DONE is "1" and the opposite case "0".
			ERR	BOOL	Error state of function block execution ● Turns ON If error occurs during the execution of the function block
	STAT		USINT	Error number. ● Indicates the error that occurs during execution of the function block.	
	OUT0		BOOL	Coincidence output state of OUT0. ● "0": coincidence output of OUT0 is OFF. ● "1": coincidence output of OUT0 is ON.	
	OUT1		BOOL	Coincidence output state of OUT1. ● "0": coincidence output of OUT1 is OFF. ● "1": coincidence output of OUT1 is ON.	
	OUT2		BOOL	Coincidence output state of OUT2. ● "0": coincidence output of OUT2 is OFF. ● "1": coincidence output of OUT2 is ON.	
	OUT3		BOOL	Coincidence output state of OUT3. ● "0": coincidence output of OUT3 is OFF. ● "1": coincidence output of OUT3 is ON.	

4.4 Error code on the function block

■ The errors on the output variable “STAT” of function blocks and the resolutions in accordance with them is shown below

STAT No.	Local/ Remote	Descriptions	Resolutions
0	Local	Operating with no fault	-
1		The base number is not within the proper setting range.	Correct the base number within the proper range.
2		H/W error of the base	Contact with the service station.
3		The slot number is not within the proper setting range	Correct the slot number within the proper range.
4		The slot is empty	Mount the high speed counter module to the slot
5		The module loaded isn't the high speed counter module	Mount the high speed counter module to the slot
6		-	-
7		H/W error of the high speed counter module	Contact with the service station.
8		The high speed counter module's shared memory error	Contact with the service station.
9		-	-
128	Remote	H/W error of the communication module for remote	See the manual of the remote communication module
129		The base location number is not within the proper setting range	Correct the number within the proper range.
131		The slot location number is not within the proper setting range	Correct the number within the proper range.
133		Another module is mounted on the selected slot.	Mount the high-speed counter module to the slot.
135		H/W error of the high speed counter module	Contact with the service station.
136		The high speed counter module's shared memory error	Contact with the service station.
137		The channel number is not within the range.	Correct the channel number within the range.

Chapter 5 GM Programming

5.1 Programming example

- If not especially noted, this section explains programming examples in reference with the G4F – HO1A that is mounted onto the system given below
- System configuration

GM4-	GM4-	G4I-	G4F-	G4Q-	G4Q-
PA2A	CPUA	D22A	HO1A	TR2A	TR2A
Power	CPU	Slot0	Slot1	Slot2	Slot3

5.1.1 Linear/Ring count setting

- Function block : HSCB_MOD
- Without selecting "Linear/Ring count" High-Speed Count Module is executed as the linear count.
Following example shows how to select "Ring count" and user-defined maximum value/ minimum value.
- When selecting "Ring count" User-defined maximum/minimum value should be set.
- Operating procedure : RING On -> LINEAR_RING =1

RING_MIN = 0, RING_MAX = 500.

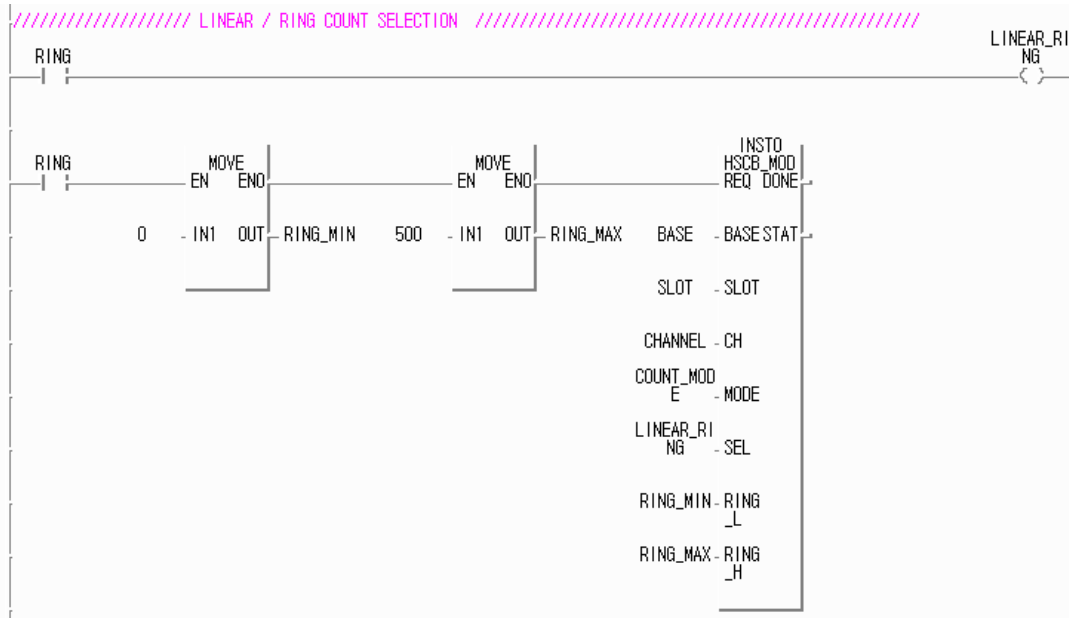

Remark

After setting the ring count, if PLC is off, the setting is initialized and PLC is executed as the linear count.

5.1.2 Count mode setting

- Function block : HSCB_MOD
- Count mode : 2 phase multiple of 1, 2 phase multiple of 2, 2 phase multiple of 4, CW/CCW,
 1 phase multiple of 1(up/down count by program), 1 phase multiple of 2(up/down count by program),
 1 phase multiple of 1(up/down count by phase B), 1 phase multiple of 2(up/down count by phase B).
- Without selecting "Count mode" High-Speed Count Module is executed as 2 phase multiple of 1.
- Operating procedure: `_2PM1 ON -> COUNT_MODE = 0`

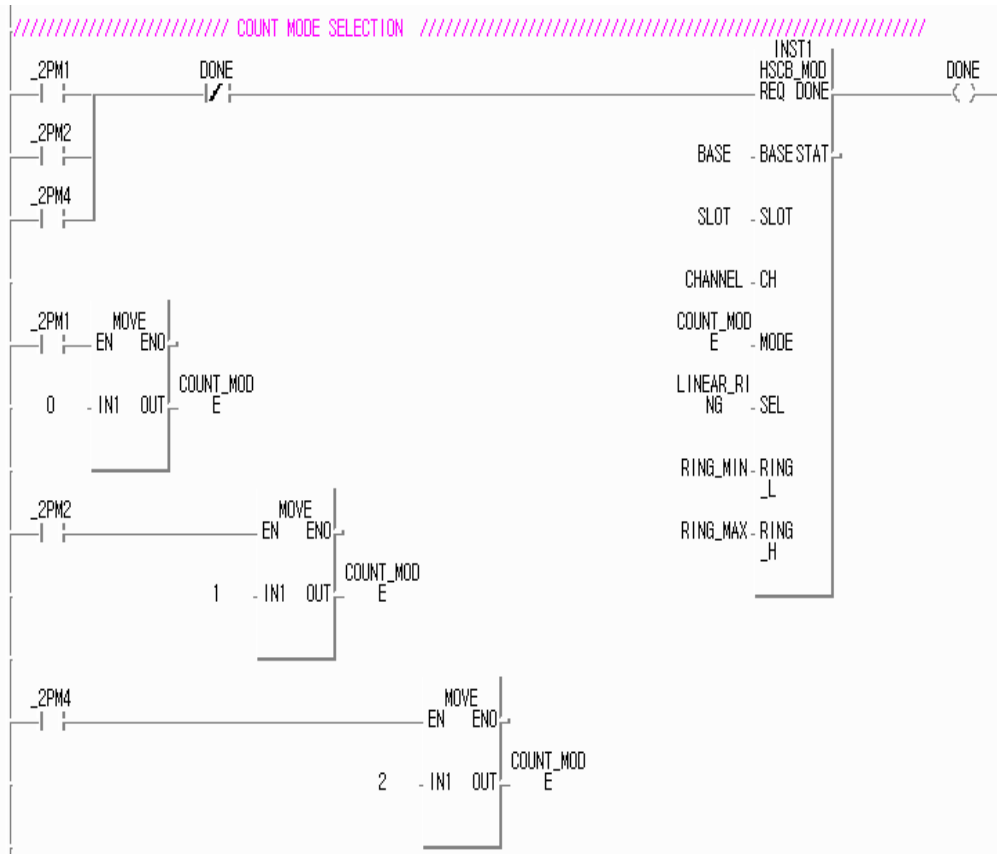

Remark
 After setting the count mode , if PLC is off, the setting is initialized and PLC is executed as the 2phase multiple of 1..

5.1.6 Count reading

- Function block : HSCB_CNT,HSCB_WR
- To read the current count value, count enable command should be turned on.
- Operating procedure: CNT_START ON -> CNT_ENABLE ON , HSCB_CNT function block enable.

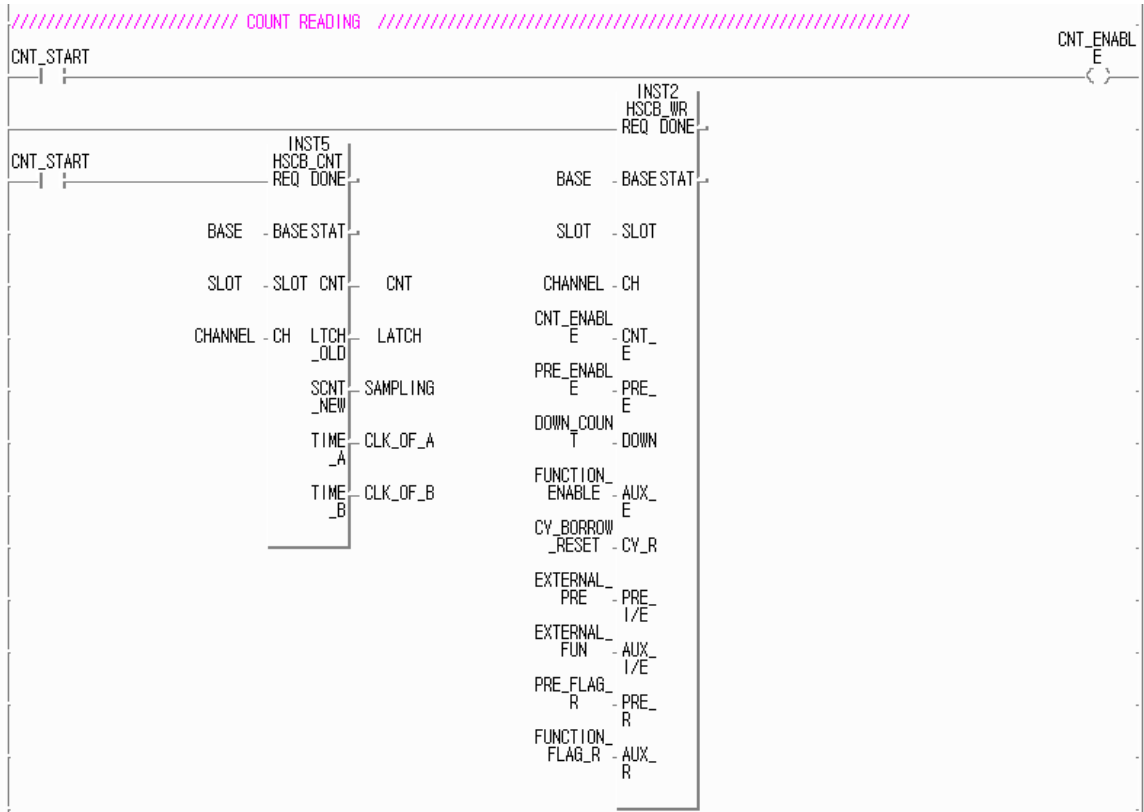

Remark

Before reading the current count, count mode and linear/ring count should be set. If count mode and linear/ring count is not set, High-Speed Counter Module is executed as a default (2 phase multiple of 1 and linear count).

5.1.7 Comparing enable and Coincidence output enable

- Function block: HSCB_OUT
- Coincidence output condition and user-defined value should be set before Comparing enable command and coincidence output enable command is turned on.
- If comparing enable command is ON but coincidence output enable command is OFF, only LED is turned on.
For physical output, coincidence output enable command should be ON.
- EQ0_R ~ EQ3_R are the commands to reset the output occurred in case of "equal condition".
- Operating procedure: PHYSICAL_OUTPUT ON -> CMP_ENABLE ON, OUT_ENABLE ON.

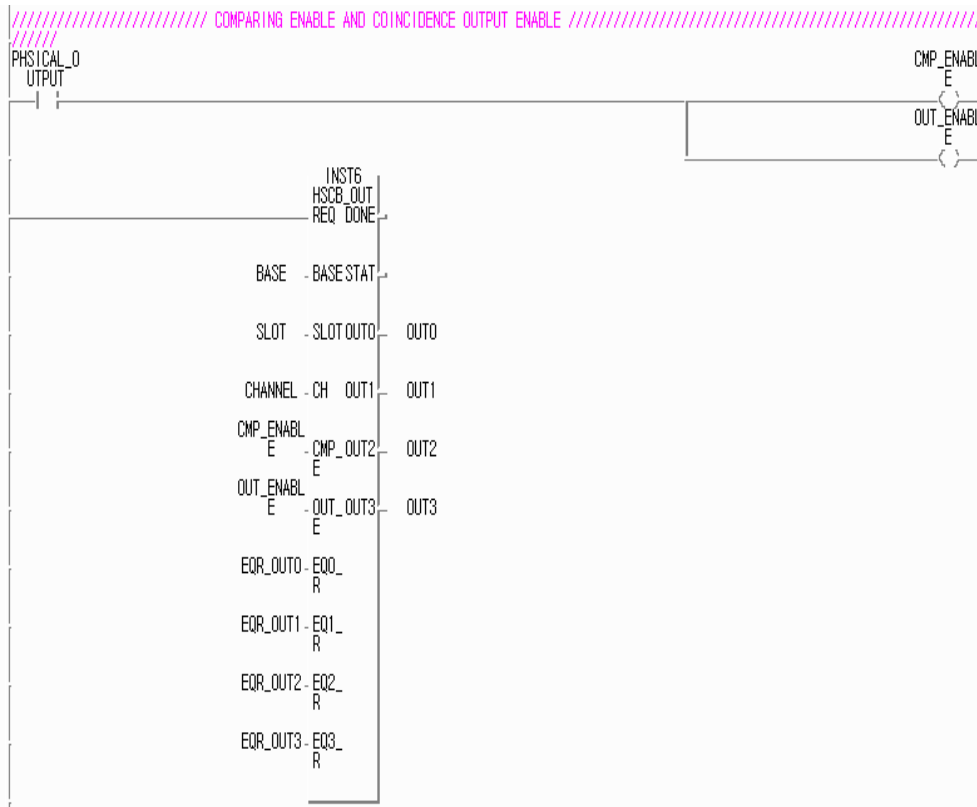

5.1.8 Carry / Borrow reset

- Function block : HSCB_WR
- To reset carry or borrow the carry/borrow reset command(function block HSCB_WR's CY_R) should be ON.
- For linear count, when carry or borrow occurs, count stops but for ring count , count doesn't stops.

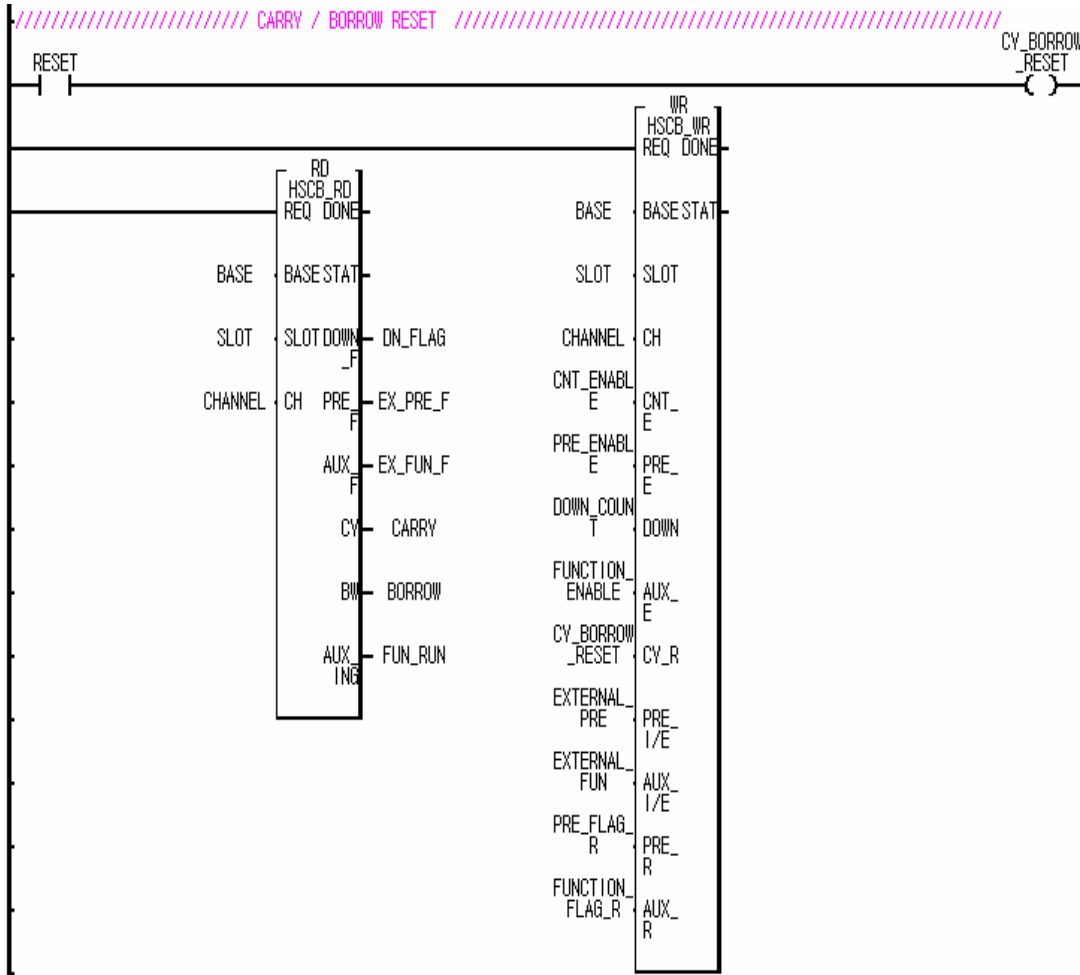

5.1.9 Function setting

1) Count clear

■ Function block : HSCB_AUX,HSCB_WR

■ This function clears the current count value when the function enable command is ON.

■ Operating procedure: CNT_CLEAR ON -> Function selection =1, function enable command ON.

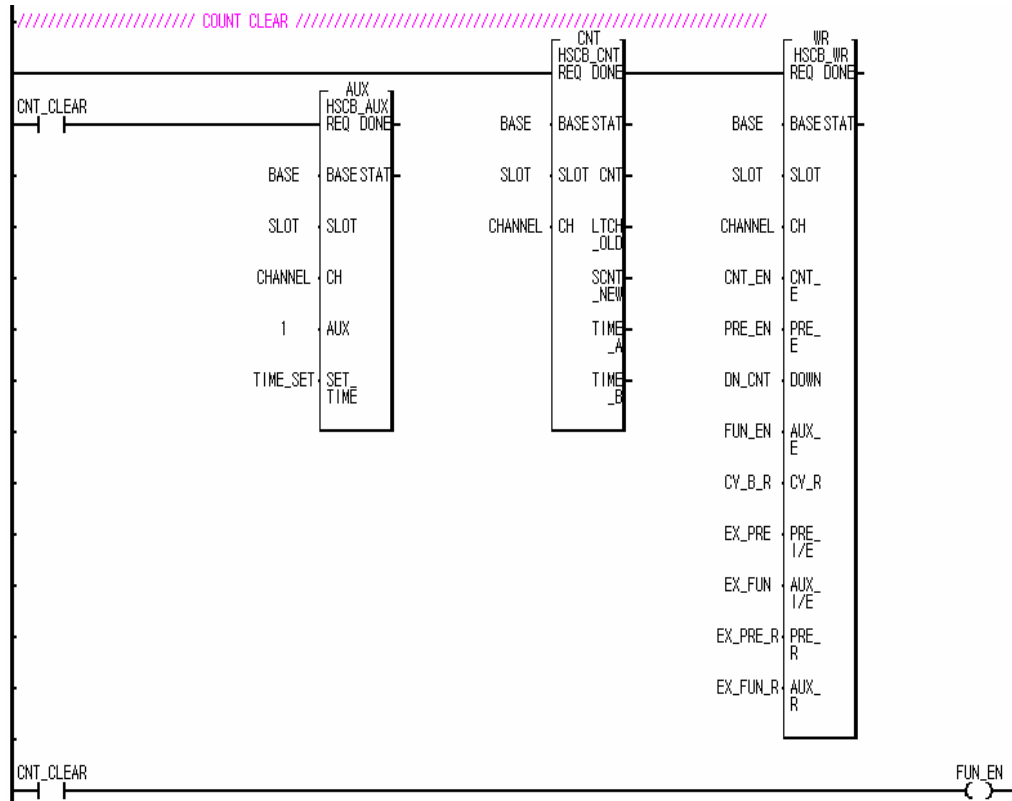

Remark

Count clear function is executed at every rising of the function enable command.

2) Count latch

- Function block : HSCB_AUX,HSCB_WR,HSCB_CNT
- This function latches the current count value and stores in the buffer ti when the function enable command is ON.
- The latched value is dispalyed at the function block HSCB_OUT's LATCH.
- Operating procedure: CNT_LATCH ON -> Function selection = 2 , function enable command ON.

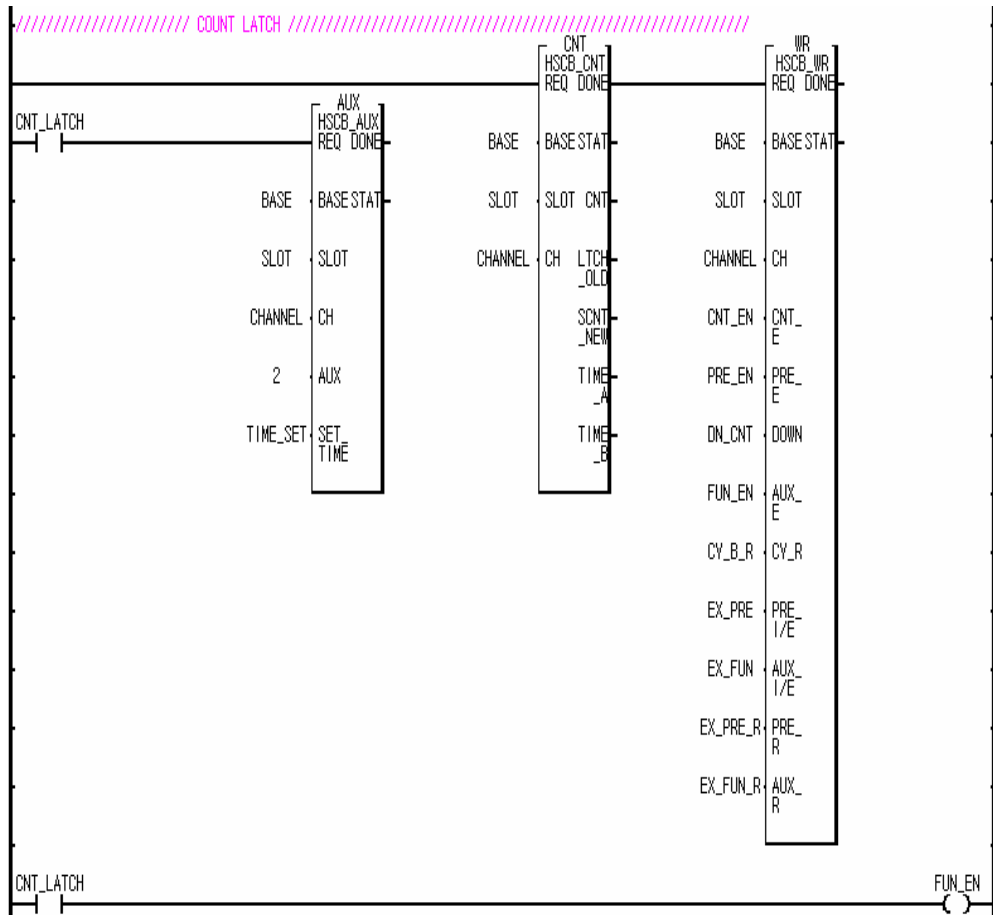

Remark
 Count latch function is executed at every rising of the function enable command.

3) Sampling count

- Function block : HSCB_AUX,HSCB_WR,HSCB_CNT
- This function counts during the preset time and stores in the buffer it when the function enable command is ON.
- During the sampling count, the sampling count value is displayed at the function block HSCB_CNT's LTCH_NEW.
- Operating procedure: SAMPL_CNT ON -> Function selection(AUX) = 3, Preset time = 3second,

function enable command(AUX_E) ON.

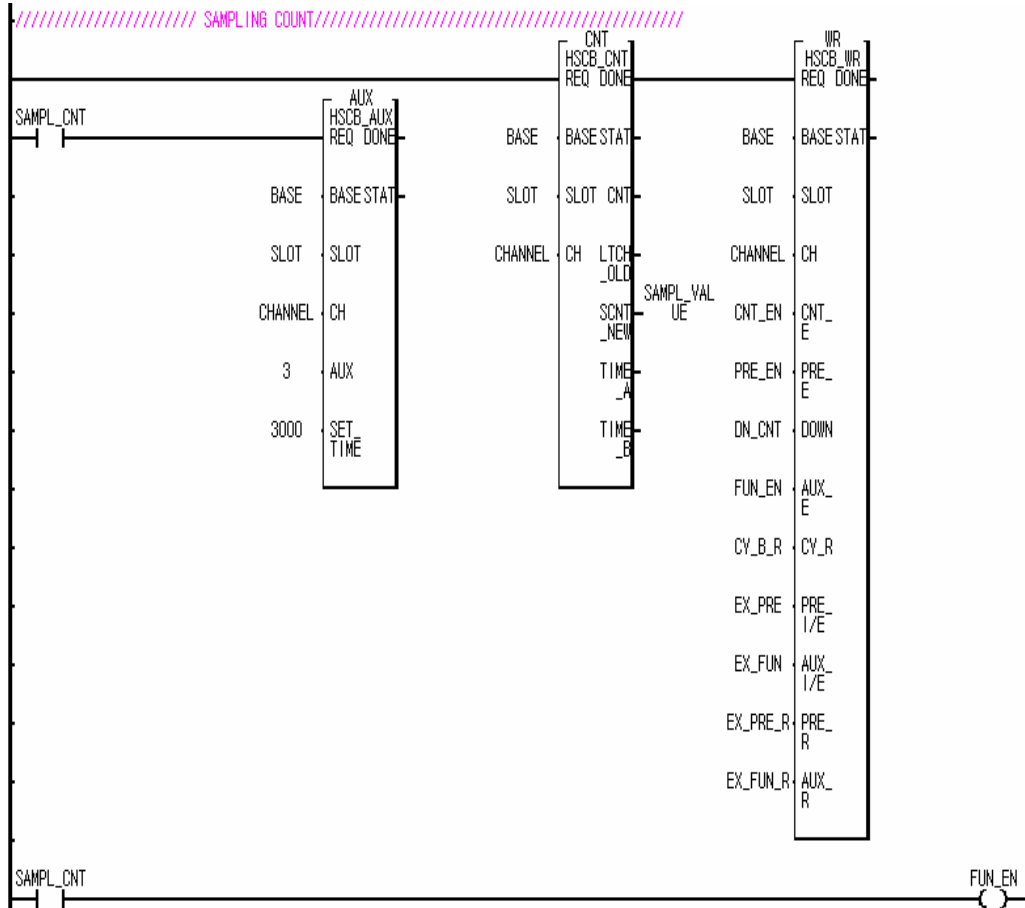

Remark

Sampling count function is executed at every rising of the function enable command during the preset time.

4) Pulse frequency count

- Function block : HSCB_AUX,HSCBWR,HSCB_CNT
- This function counts the phase A/B clocks and stores in the buffer it at every second during the function enable command is ON.
- Operating procedure: FREQ_CNT ON -> Function selection(AUX) =4,function enable command(AUX_E) ON.

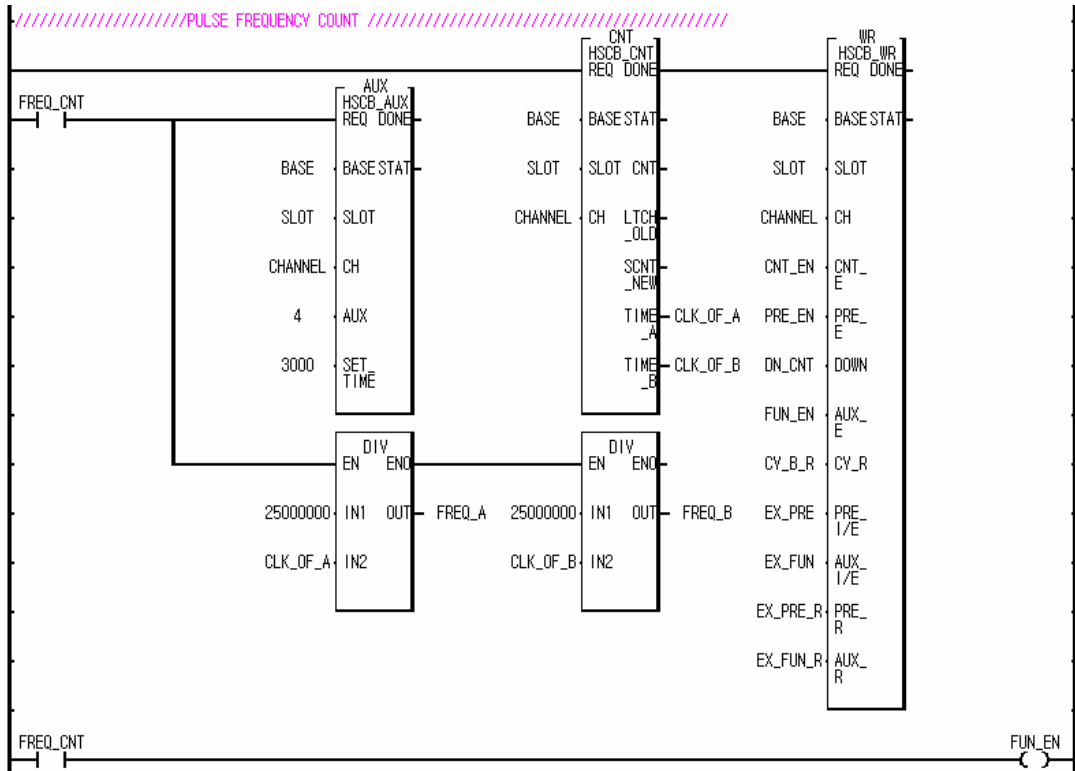

Remark

Pulse frequency count function is executed at every second during the function enable command is ON.

5) Periodic pulse count

- Function block : HSCB_AUX,HSCB_WR,HSCB_CNT
- This function counts the periodic pulse and stores in the buffer it at every preset time during the function enable command is ON.
- Operating procedure: PERIODIC_CNT ON -> Function selection(AUX) =5, Preset time = 3second,

function enable command(AUX_E) ON.

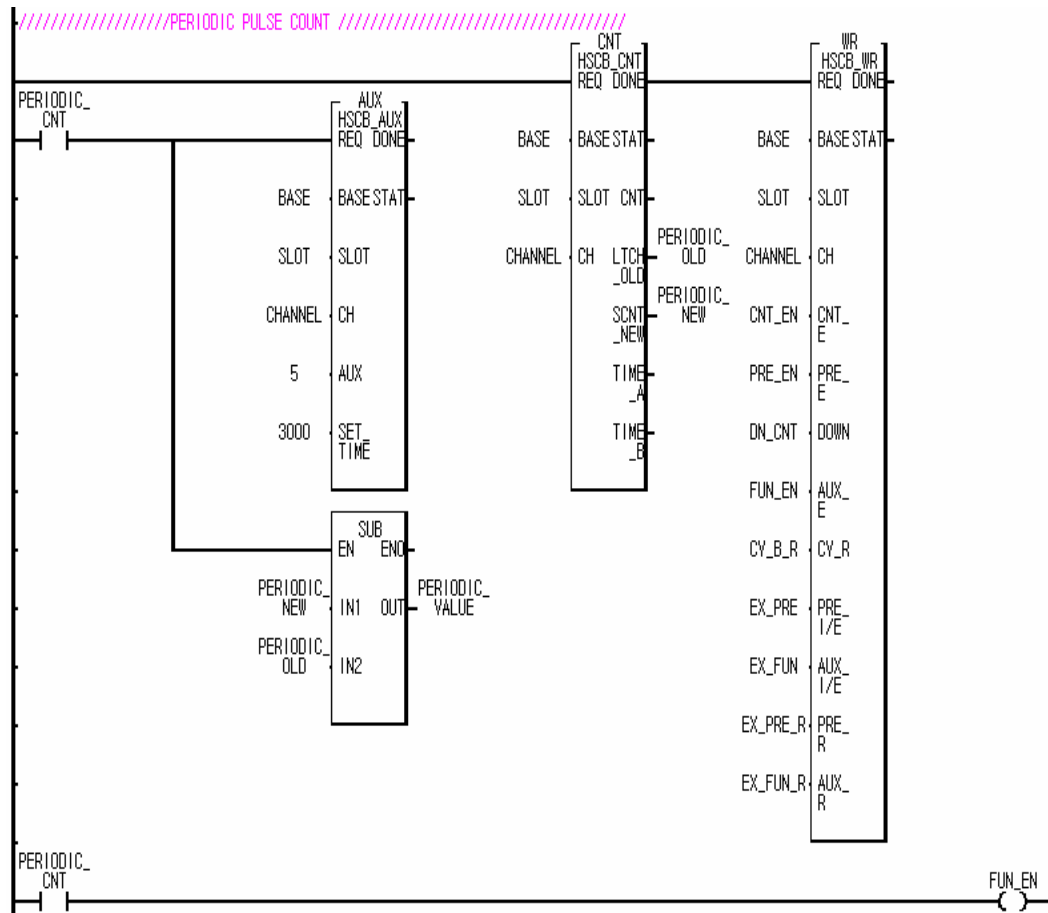

Remark

Periodic pulse count function is executed at every preset time during the function enable command is ON.

5.2 Read/ Write High-Speed Counter Module mounted onto the remote station

■ System configuration

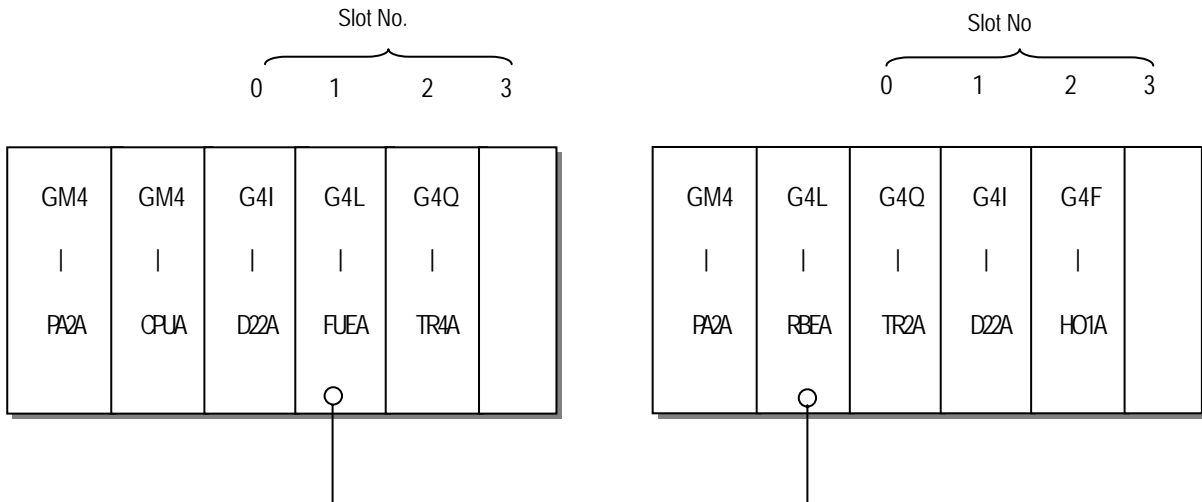

NET_NO : The slot number where the G4L – FUEA is mounted = 1

ST_NO : G4L-RBEA Station No. = 3

BASE : The base number where the G4F – HSCA is mounted = 1

SLOT : The slot number where the G4F – HSCA is mounted = 2

5.3 Application Examples

5.3.1 Program for moving the cart

■ System Configuration

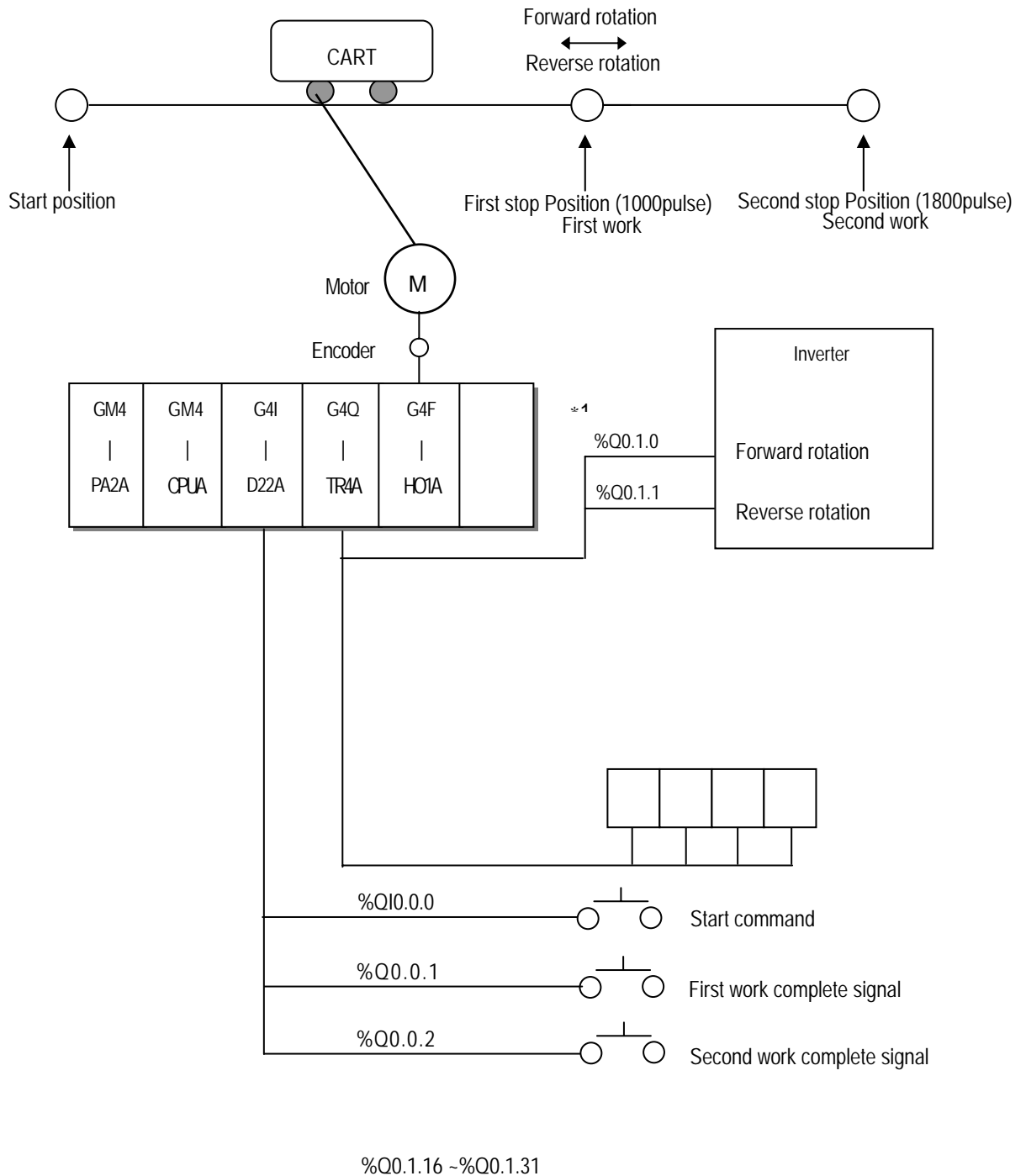

■ Operation Description

- The motor for moving the cart rotates with start command, and makes the cart stop at the first stop position with the High-speed count module counting the encoder signals from the motor.
- Then, if the first work complete signal turns ON, the motor moves the cart to stop at the second stop position. When the second work complete signal turns on, the motor return the cart to the start position.

■ Input/Output Signal Allocation

%I0.0.0 : Start Command
 %I0.0.1 : 1st Work Complete Signal
 %I0.0.2 : 2nd Work Complete Signal

} Input

%Q0.1.0 : Motor forward rotation signal (On : forward rotation , Off : Stop)
 %Q0.1.1 : Motor reverse rotation Signal (On : Backward rotation, Off : Stop)
 %Q0.1.16 - %Q0.1.31 : Indicates the current count value(BCD) of the High-speed counting module.

} Output

■ Driving figure

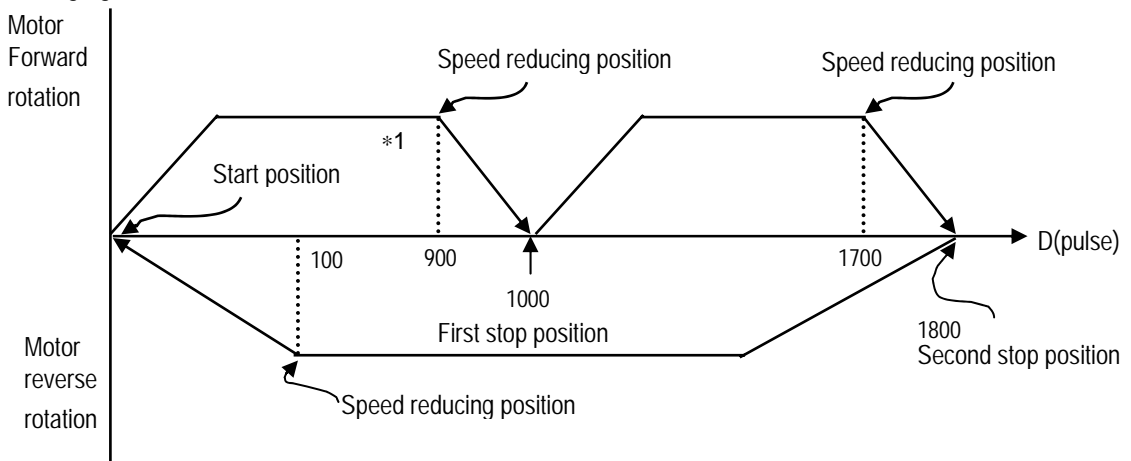

*1 ▶ 100(Difference between stop position and speed reducing position) is an interval delayed by reducing timing of the inverter

■ Operation Timing

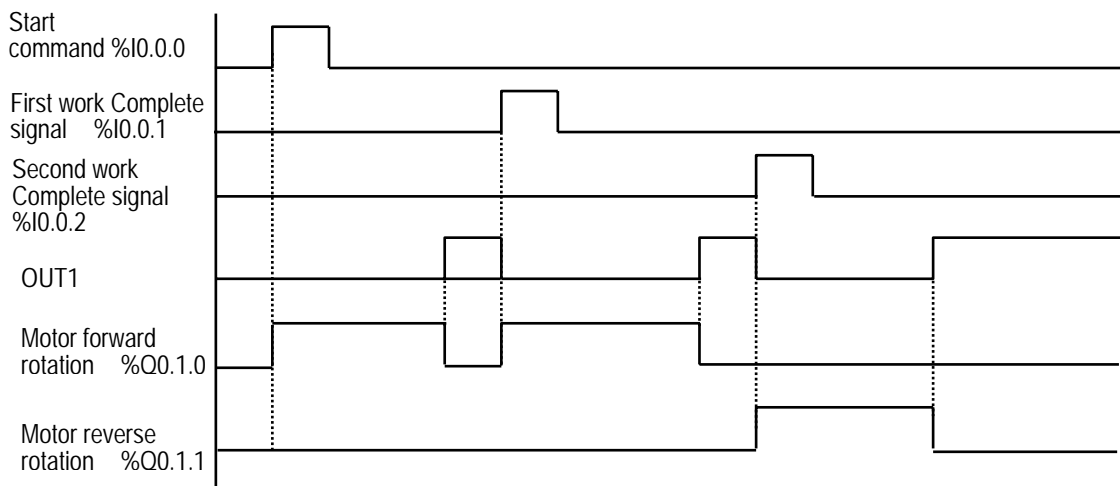

■ Program

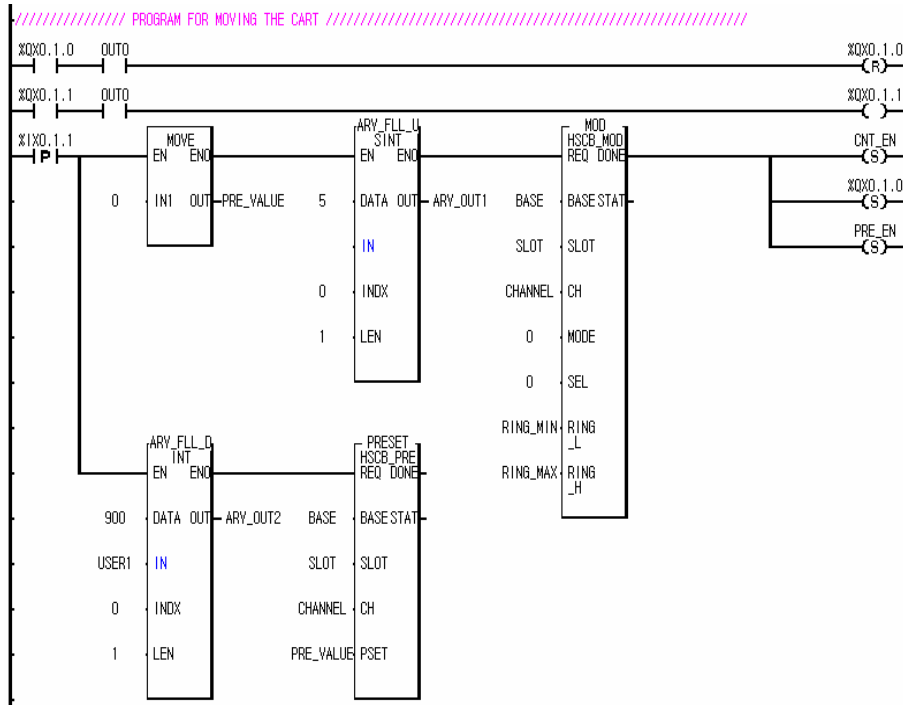

Motor forward rotation stops when speed-reducing position is passed
 Motor reverse rotation stops when speed-reducing position is passed

If start command is ON,
 PRE_VALUE=0
 USER1 = 900

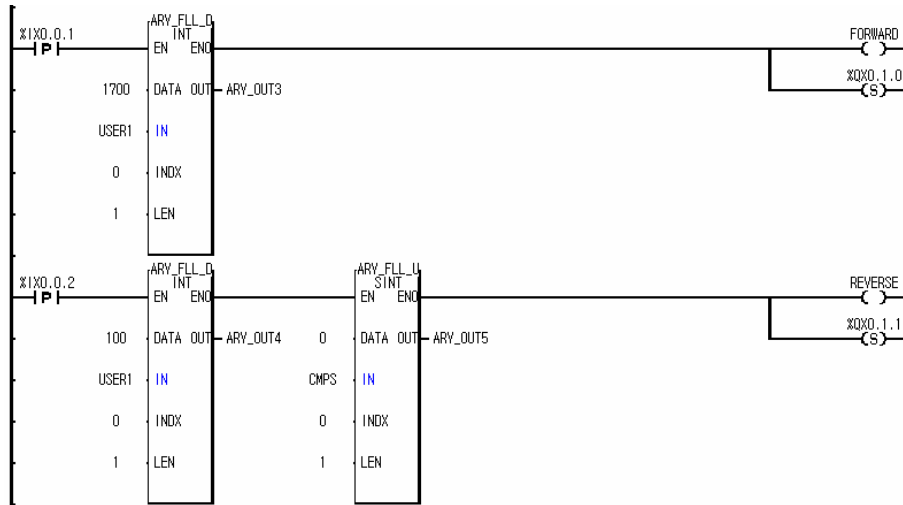

When the first work is completed, USER1=1700 and the motor starts forward rotation.

When the first work is completed, USER1=100 and the motor starts reverse rotation.

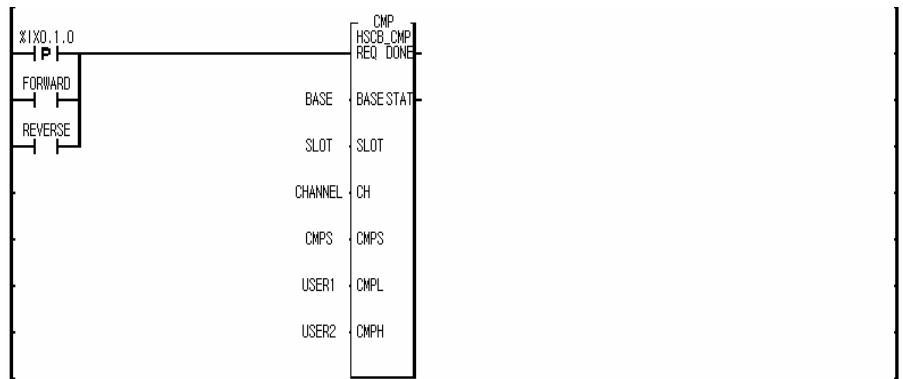

When first or second works or start command is completed, USER1 is changed.

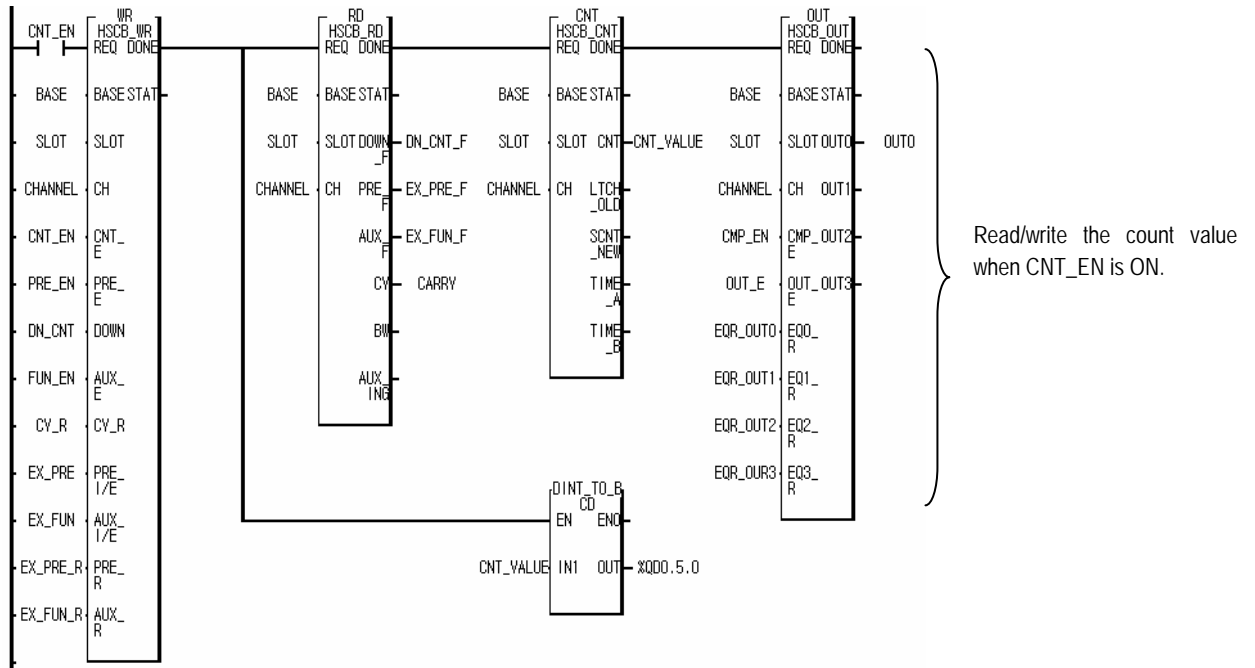

5.3.2 Turntable control program

■ System configuration

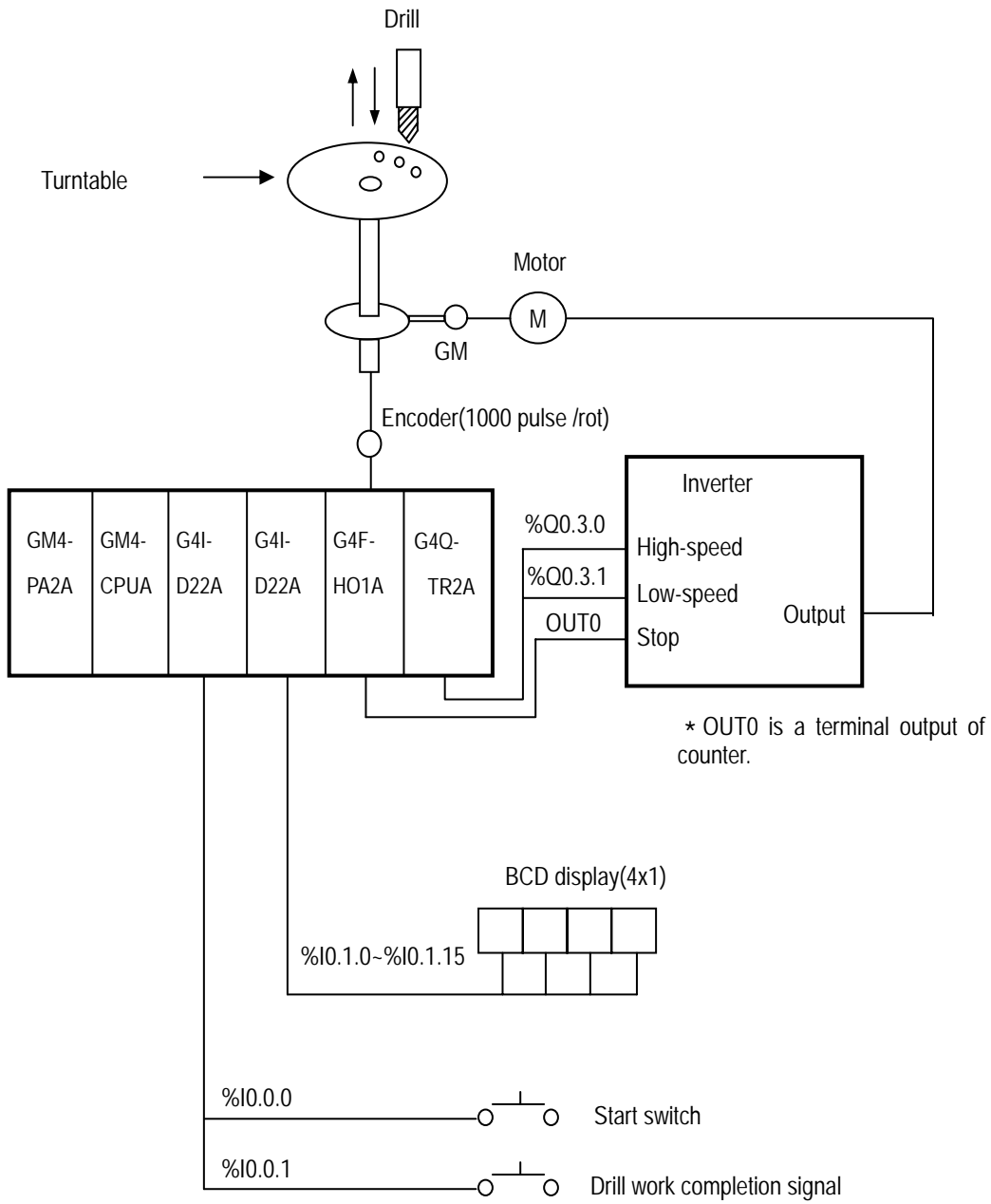

■ Operation description

If the start switch is pushed, the turntable rotates the preset angle(60 °) and stops.

When the first drill work completion signal is ON, again the turntable rotates 60 ° . 6 times work like this is repeated

■ Driving figure

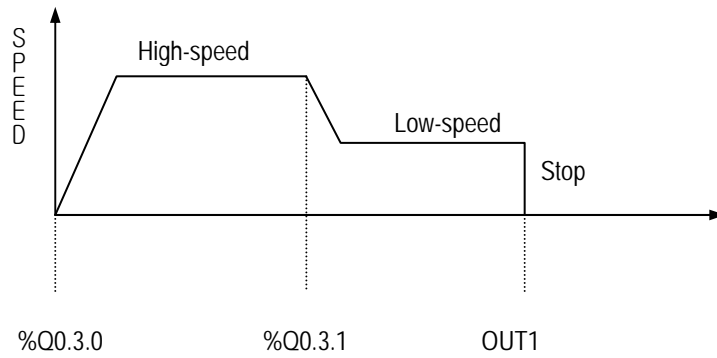

■ Program

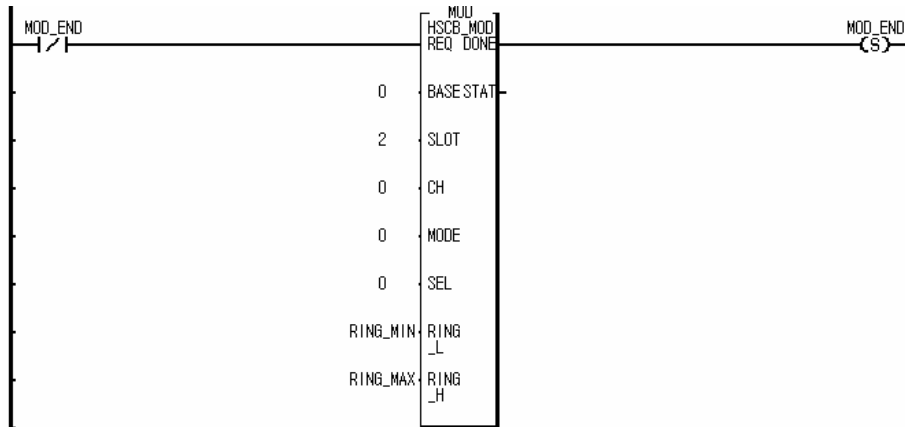

- 1.Count mode=0
(2phase multiple of1)
- 2.Linear count

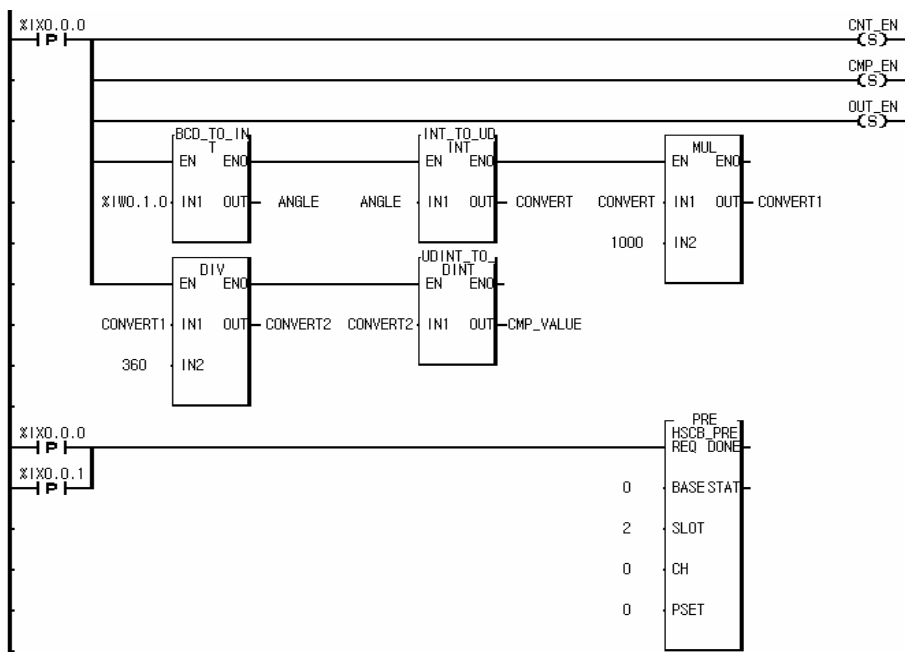

- 1.Count enable command ON
- 2.Compare enable command ON.
- 3.Output enable command ON.

$360^\circ : 1000\text{pulse} = 60^\circ : x$
 $x = 166$

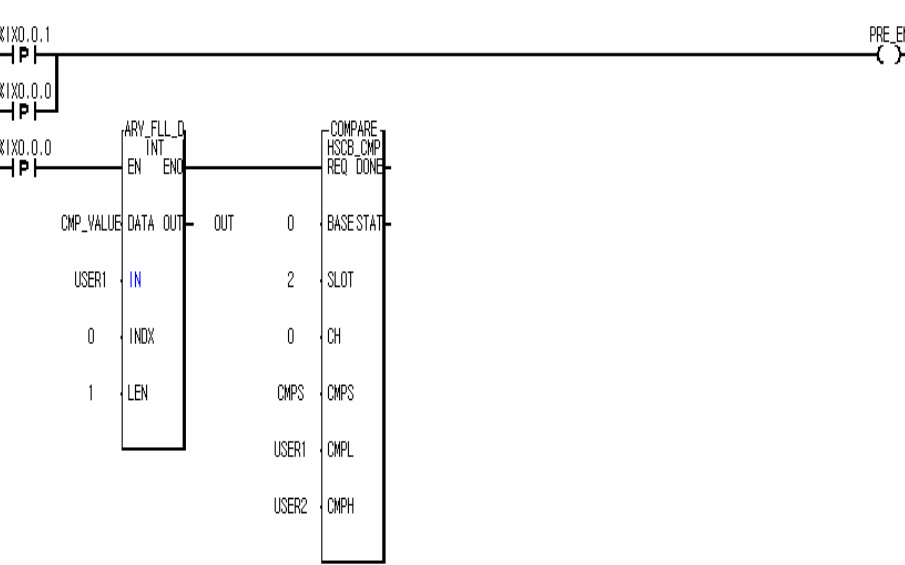

Preset value=0

Preset enable command ON

CMPS = 2
 USER1=166

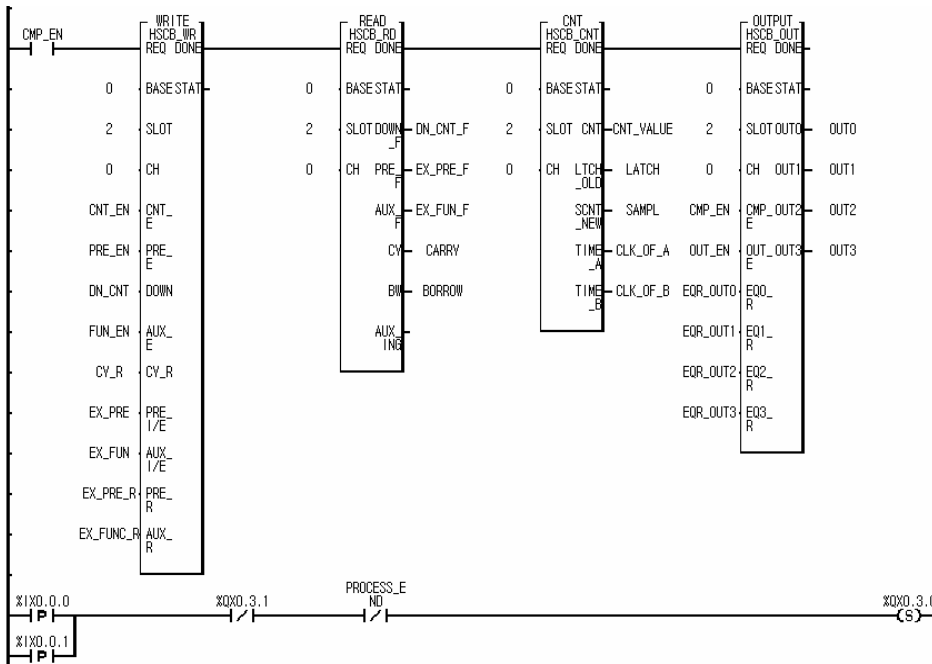

Module information
read/write and
Count read

High-speed operation

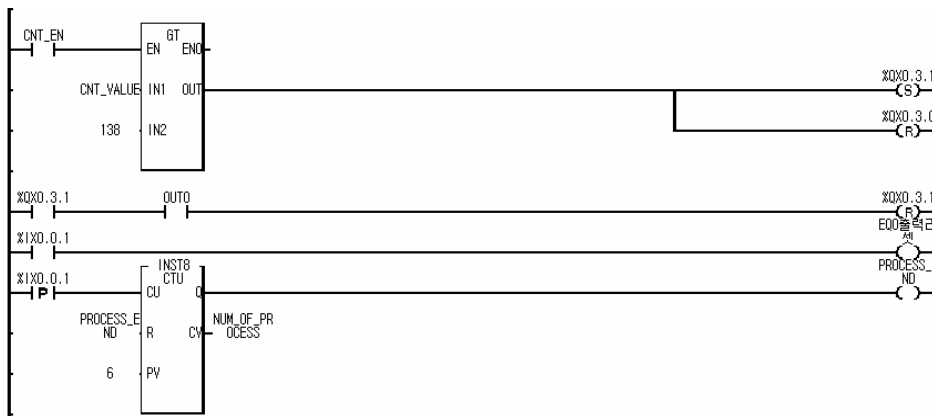

If the angle is 50,
Motor is executed as
low speed

If the angle is 60,
Motor is stopped by
coincidence output.(=)

After 6times is repeated,
All procedure is completed.

Chapter 6 Buffer memory and I/O signal

6.1 Block diagram

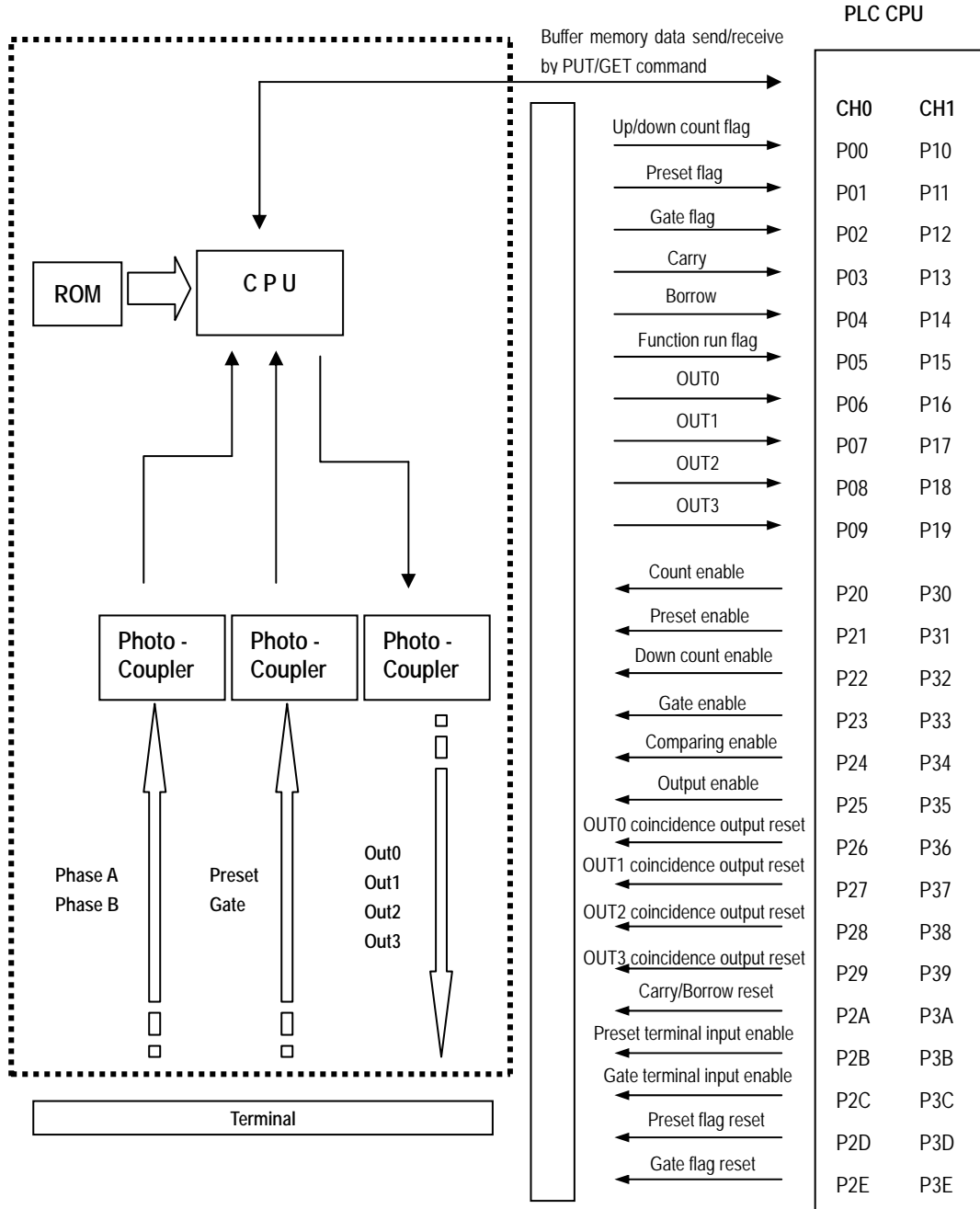

※ The above shows the operation block diagram which the I/O word number is 0 and G4F-HO1A/HD1A, G6F-HO1A/HD1A are all same.

6.2 Buffer memory configuration

■ The high speed counter module has a Buffer Memory for data write/read to/from the PLC CPU. The PUT and PUTP command write data from the PLC CPU to the Buffer Memory. The GET and GETP command read data. (Refer to the Manuals relating to the instructions.)

6.2.1 Buffer memory configuration

1) Input area

Ch0	Ch1	Description
0000	0032	Count mode selection
0001	0033	Linear / Ring count selection
0002	0034	Function selection
0003	0035	OUT0 coincidence output selection
0004	0036	OUT1 coincidence output selection
0005	0037	OUT2 coincidence output selection
0006	0038	OUT3 coincidence output selection
0007	0039	Preset value setting
0008	0040	
0009	0041	User-defined maximum value setting for ring count
0010	0042	
0011	0043	User-defined minimum value setting for ring count
0012	0044	
0013	0045	Time setting for Sampling count or Time setting for periodic pulse count.
0014	0046	-
0015	0047	OUT0 coincidence output value for selection 0,1,2,3,4
0016	0048	OUT0 coincidence output user-defined minimum value for selection 5,6
0017	0049	OUT0 coincidence output user-defined maximum value for selection 5,6
0018	0050	
0019	0051	OUT1 coincidence output value for selection 0,1,2,3,4
0020	0052	OUT1 coincidence output user-defined minimum value for selection 5,6
0021	0053	OUT1 coincidence output user-defined maximum value for selection 5,6
0022	0054	
0023	0055	OUT2 coincidence output value for selection 0,1,2,3,4
0024	0056	OUT2 coincidence output user-defined minimum value for selection 5,6
0025	0057	OUT2 coincidence output user-defined maximum value for selection 5,6
0026	0058	
0027	0059	OUT3 coincidence output value for selection 0,1,2,3,4
0028	0060	OUT3 coincidence output user-defined minimum value for selection 5,6
0029	0061	OUT3 coincidence output user-defined maximum value for selection 5,6
0030	0062	

2) Output area

Ch0	Ch1	Description
64	80	Current count value
65	81	
66	82	Latch count value or Periodic pulse count previous value
67	83	
68	84	Sampling count value or Periodic pulse count current value
69	85	
70	86	Number of the phase A
71	87	
72	88	Number of the phase B
73	89	

6.2.2 Detail data configuration

1) Count mode selection (CH0: address 0, CH1: address 32) : 1WORD

Value(decimal)	Description
0	2 phase multiple of 1
1	2 phase multiple of 2
2	2 phase multiple of 4
3	CW / CCW
4	1 phase multiple of 1 (Up/down count by program)
5	1 phase multiple of 2 (Up/down count by program)
6	1 phase multiple of 1 (Up/down count by phase B)
7	1 phase multiple of 2 (Up/down count by phase B)

2) Ring/Linear count selection (CH0: address1,CH1:address 33) : 1WORD

Value(decimal)	Description
0	Linear count
1	Ring count

3) Function selection (CH0: address 2, CH1: address 34) : 1WORD

Value(decimal)	Description
0	-
1	Count clear function
2	Count latch function
3	Sampling count function
4	Pulse frequency count function
5	Periodic pulse count function

4) Coincidence output selection

Item	Address		Value	Description
	Ch0	Ch1		
			0	When current count < User-defined value, OUT is turned on.
OUT0	3	35	1	When current count =< User-defined value, OUT is turned on.
OUT1	4	36	2	When current count = User-defined value, OUT is turned on.
OUT2	5	37	3	When current count >= User-defined value, OUT is turned on
OUT3	6	38	4	When current count > User-defined value, OUT is turned on
-	-	-	5	When User-defined value1=<Current value =<User-defined value2, OUT is turned on.
-	-	-	6	When User-defined value1>= Current value or Current value >= User-defined value2 , OUT is turned on.

6.2.3 Status display

Ch 0 : address 76, Ch 1 : address 77.

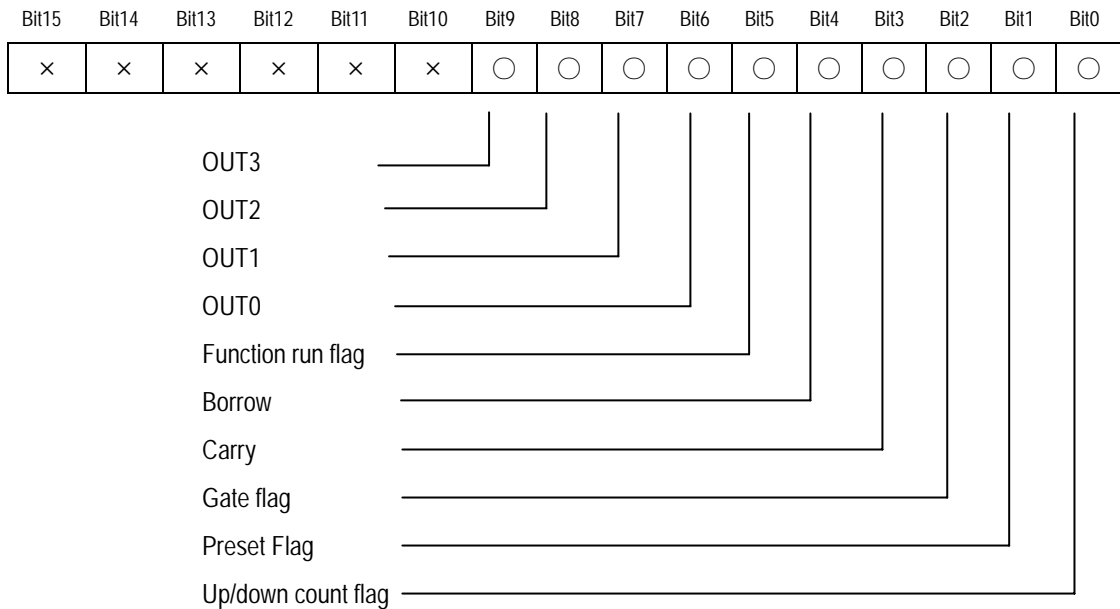

6.3 Input/Output signal

PLC <- High-Speed Counter Module			PLC -> High-Speed Counter Module		
Ch	Signal	Description	Ch	Signal	Description
0	P(N)0	Up/down count flag(ON:Down count)	0	P(N+2)0	Count enable (Level)
	P(N)1	Preset Flag		P(N+2)1	Preset enable (Edge)
	P(N)2	Gate Flag		P(N+2)2	Down count enable(Level)
	P(N)3	Carry		P(N+2)3	Function enable command (Edge, Level)
	P(N)4	Borrow		P(N+2)4	Comparison enable(Level)
	P(N)5	Function run flag		P(N+2)5	Output enable(Level)
	P(N)6	OUT0		P(N+2)6	OUT0 coincidence output reset(Edge)
	P(N)7	OUT1		P(N+2)7	OUT1 coincidence output reset (Edge)
	P(N)8	OUT2		P(N+2)8	OUT2 coincidence output reset (Edge)
	P(N)9	OUT3		P(N+2)9	OUT3 coincidence output reset (Edge)
	P(N)A	-		P(N+2)A	Carry/Borrow reset (Edge)
	P(N)B	-		P(N+2)B	Preset terminal input enable
	P(N)C	-		P(N+2)C	Gate terminal input enable
	P(N)D	-		P(N+2)D	Preset flag reset
	P(N)E	-		P(N+2)E	Gate flag reset
	P(N)F	-		P(N+2)F	-
1	P(N+1)0	Up/down count flag(ON:Down count)	1	P(N+3)0	Count enable (Level)
	P(N+1)1	Preset Flag		P(N+3)1	Preset enable (Edge)
	P(N+1)2	Gate Flag		P(N+3)2	Down count enable(Level)
	P(N+1)3	Carry		P(N+3)3	Function enable command (Edge, Level)
	P(N+1)4	Borrow		P(N+3)4	Comparison enable(Level)
	P(N+1)5	Function run flag		P(N+3)5	Output enable(Level)
	P(N+1)6	OUT0		P(N+3)6	OUT0 coincidence output reset(Edge)
	P(N+1)7	OUT1		P(N+3)7	OUT1 coincidence output reset (Edge)
	P(N+1)8	OUT2		P(N+3)8	OUT2 coincidence output reset (Edge)
	P(N+1)9	OUT3		P(N+3)9	OUT3 coincidence output reset (Edge)
	P(N+1)A	-		P(N+3)A	Carry/Borrow reset (Edge)
	P(N+1)B	-		P(N+3)B	Preset terminal input enable
	P(N+1)C	-		P(N+3)C	Gate terminal input enable
	P(N+1)D	-		P(N+3)D	Preset flag reset
	P(N+1)E	-		P(N+3)E	Gate flag reset
	P(N+1)F	-		P(N+3)F	-

※ 'N' is the I/O word number of the High Speed Counter module.

Remark

Gate is a same term with Function. Gate is used only for the terminal.

Chapter 7 MK Programming

7.1 Buffer memory read/write

7.1.1 Buffer memory read

- The commands given below are used to read data from the buffer memory of the high speed counter module to the CPU. The data read can be stored to the CPU memory (F area is not excluded.).

1) GET/GETP

Always execution during the execution condition On.		GET
Execution when the execution condition rises.		GETP

2) GET/GETP command configuration

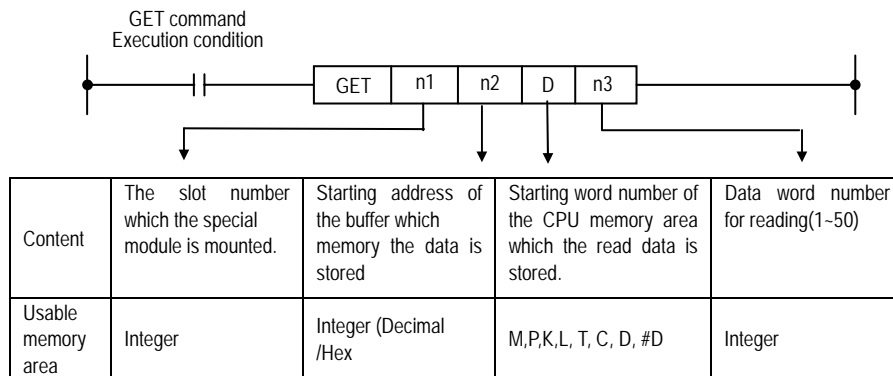

3) n1 setting method

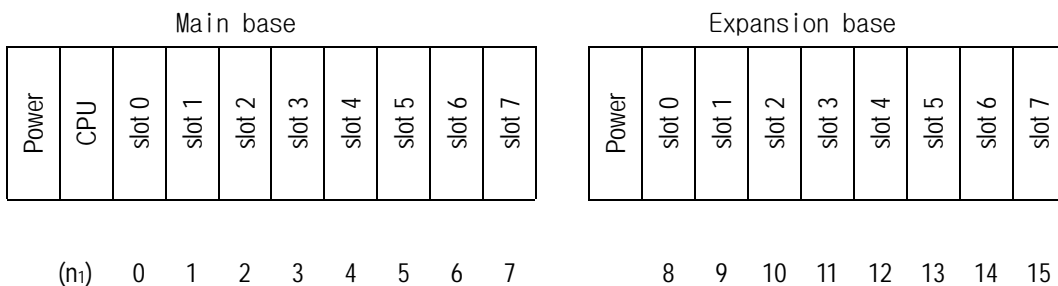

4) GET/GETP using example

Example1

In case, the high speed counter module is mounted on the first expansion base and CPU reads buffer memory address 5 and stores two words in the D15 and D16.

(D area) CPU

D15 (Data)
D16 (Data)

High-Speed Counter Module

Buffer memory (address)

(Data) 5
(Data) 6

Read ←

Execution condition

[GET 8 5 D0015 2]

Example2

In case ,the same data area of the example 1 is read at the execution condition's rise.

Execution condition

[D M0008]

[GET 8 5 D0015 2]

M0008

Example3

In case,High-Speed Counter Module is mounted in the slot 4(main base) and CPU reads 6words(from buffer memory 10, stores the data to D0001~D0006.

CPU

D0001	Data 1
D0002	Data 2
D0003	Data 3
D0004	Data 4
D0005	Data 5
D0006	Data 6

High-Speed Counter Module

Data 1	10
Data 2	11
Data 3	12
Data 4	13
Data 5	14
Data 6	15



GET ←
Read

Execution condition

[GET 4 10 D1 6]

7.1.2 Buffer memory write

1) PUT/PUTP

Always execution during the execution condition On.		PUT
Execution when the execution condition rises.		PUTP

2) PUT/PUTP command configuration

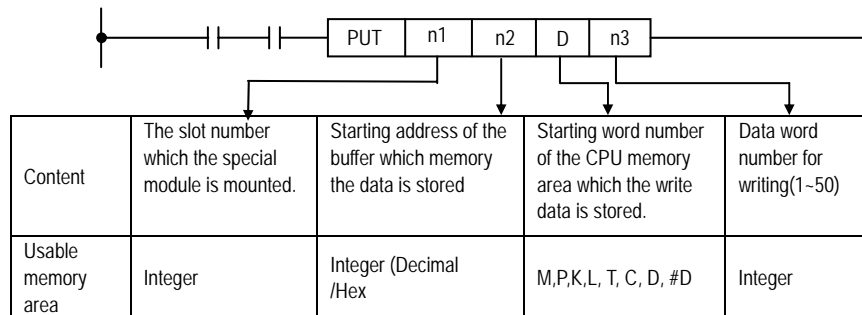

3) n1 setting method

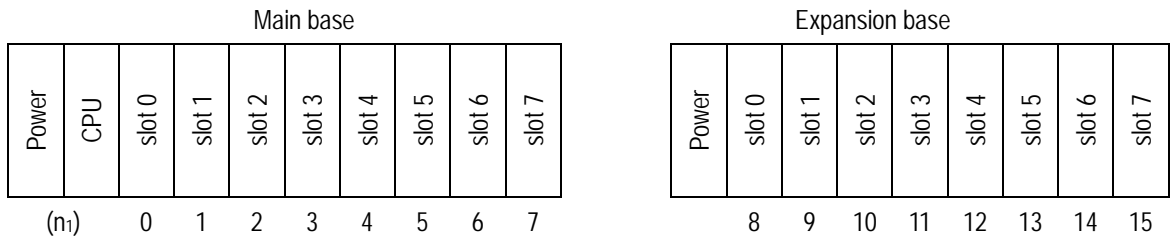

4) PUT/PUTP using example

Example1

● 16 bit data write

In case, the high speed counter module is mounted on the first expansion base's slot2 and CPU writes the data of D0090 to buffer memory address 0.

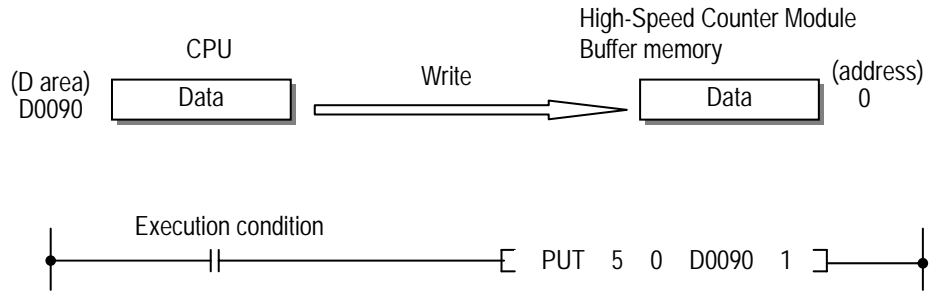

Example2

● 32-bit data write

In case, the high speed counter module is mounted on the first expansion base's slot5 and CPU writes the data of D0051/ 52 to buffer memory address 2/3.

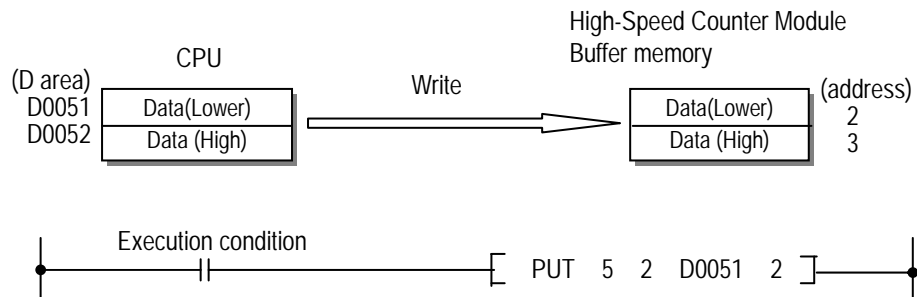

Example3

● Integer write

In case, the high speed counter module is mounted on the main base's slot5 and writes h0401 to buffer memory address4

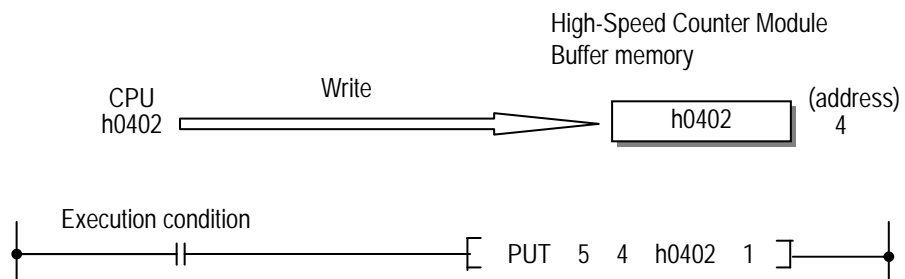

7.2 Programming example

■ If not especially mentioned, this section explains programming examples in reference with G4F-HO1A that is mounted on the system as below.

■ System configuration

GM4-	K4P-	G4I-	G4Q-	G4F-	G4Q-
PA2A	15AS	D22A	RY2A	HO1A	TR2A
Power	CPU	Slot0	Slot1	Slot2	Slot3

P00 P01 P02 P03 P04 P05 P06 } I/O Word number

7.2.1 Linear/Ring count selection

■ If linear/ring count is not selected, High-Speed counter Module is executed as linear count.

The following is a program example that ring count is selected and CPU writes user-defined max/min value to buffer memory.

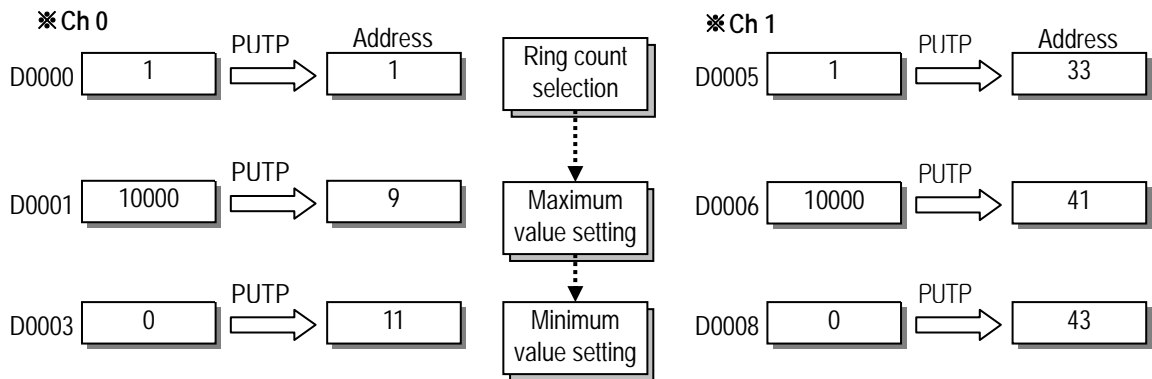

7.2.2 Count mode selection

■ The following is a program example how to set count mode(2phase multiple of1, 2phase multiple of2, 2phase multiple of4, 1phase multiple of1(up/down count by program), 1phase multiple of2(up/down count by program), 1phase multiple of1(up/down count by phase B), 1phase multiple of2(up/down count by phase B).

If count mode is not selected, High-Speed counter Module is executed as 2phase multiple of1.

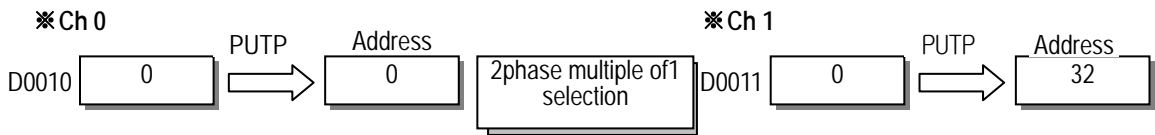
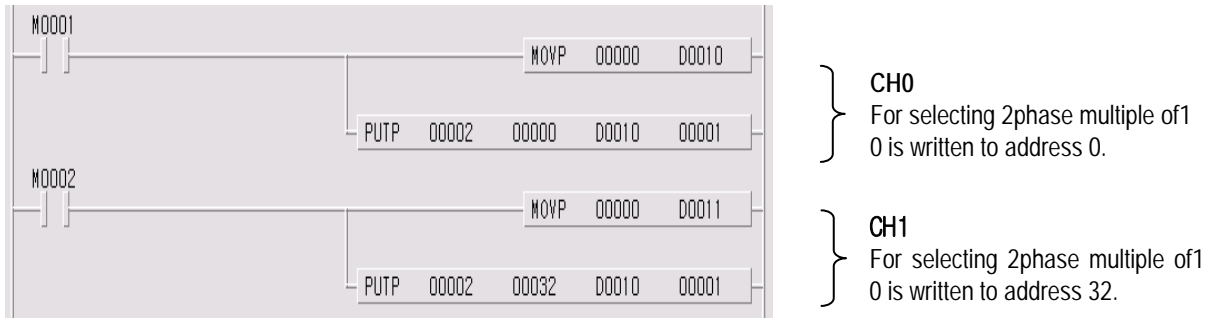

7.2.3 Count enable

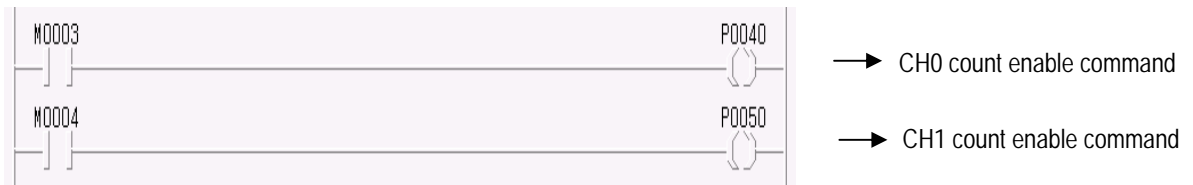

7.2.4 Preset enable(by program)

■ The following is a program example writing the preset value 10000 to buffer memory.

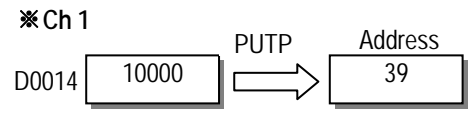
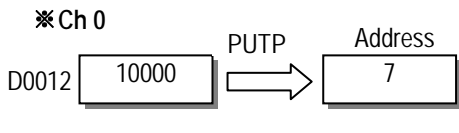
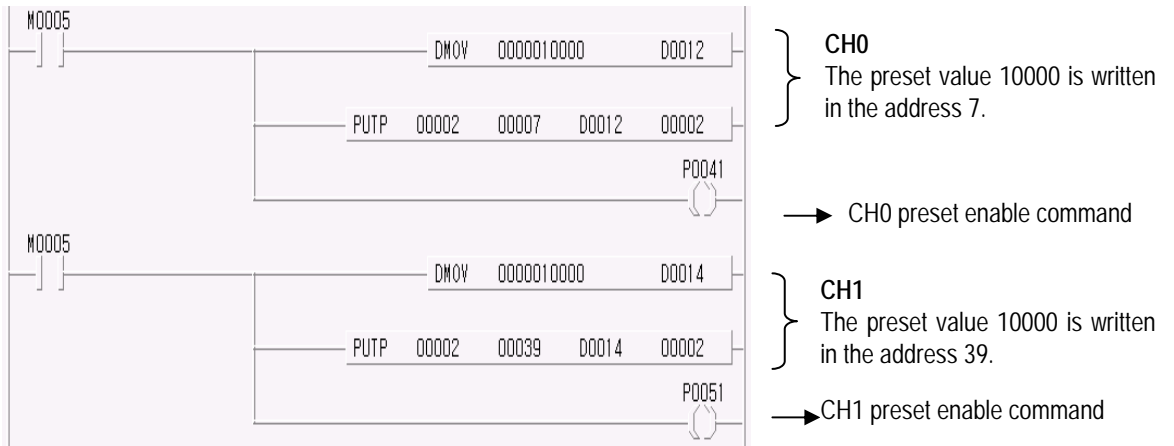

7.2.5 Count reading

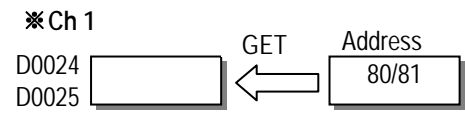
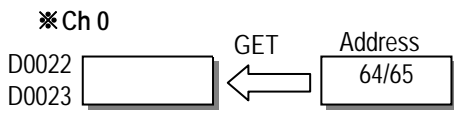
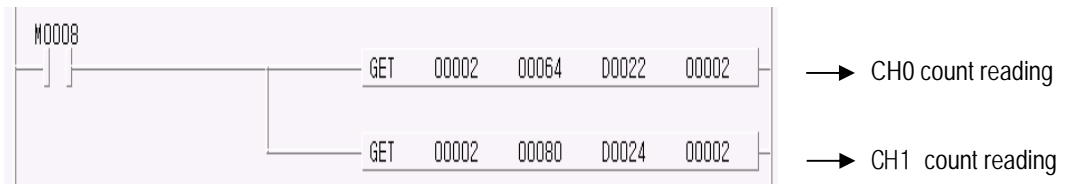

7.2.6 Coincidence output selection and setting

■ The following is a program example selecting the coincidence output mode4 and writing user-defined value 500 to buffer memory.

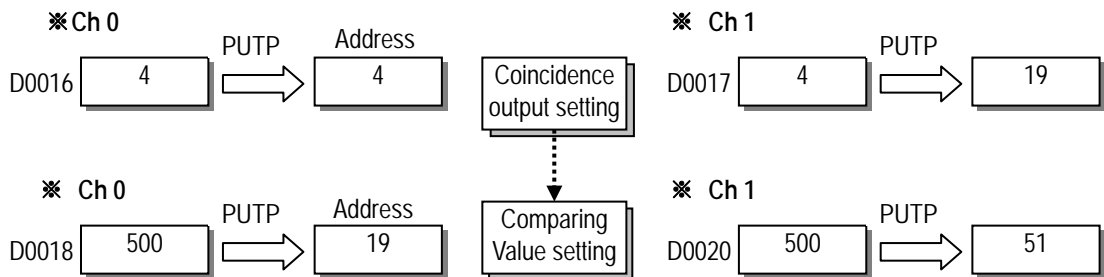
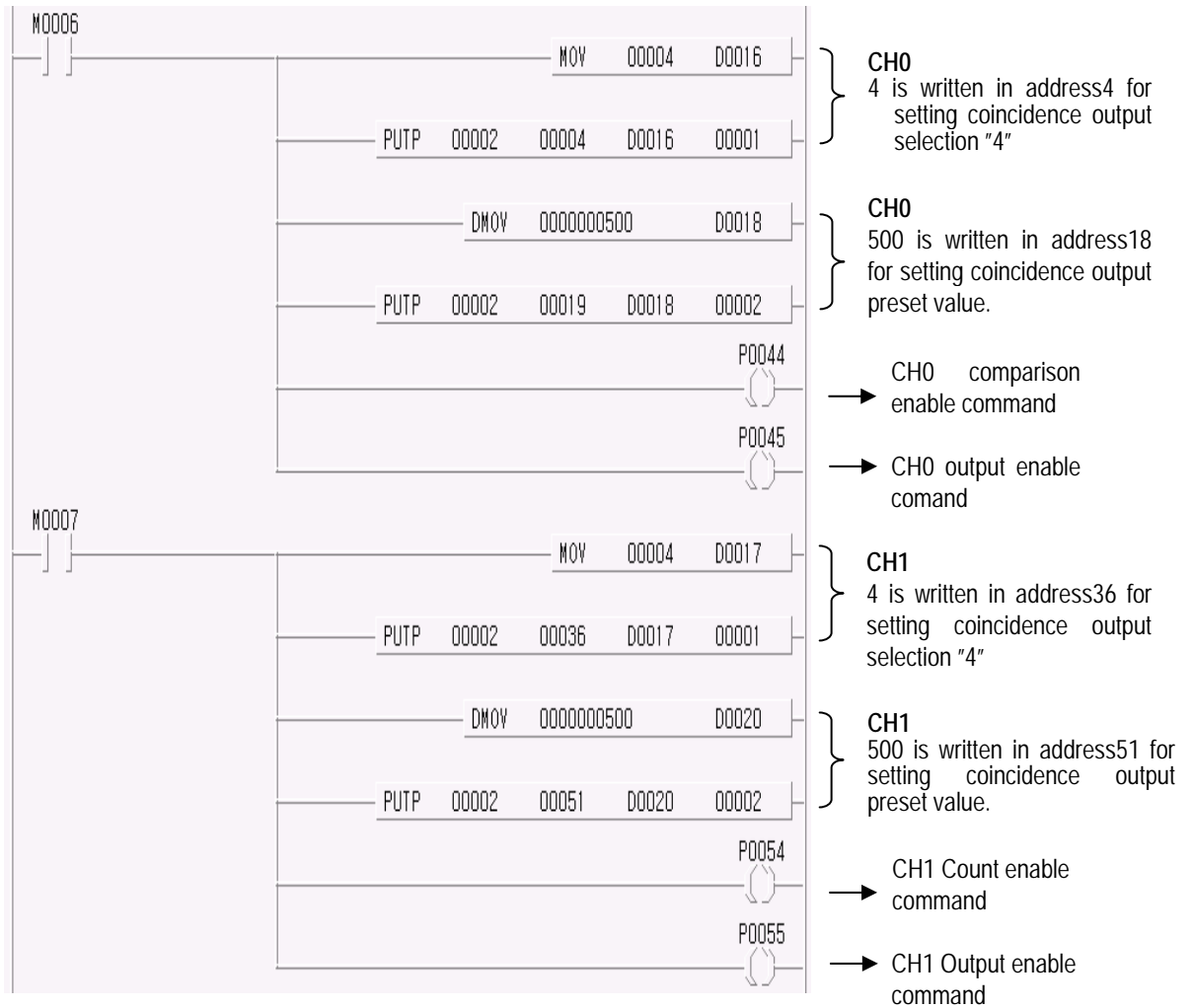

7.2.7 Carry/Borrow reset

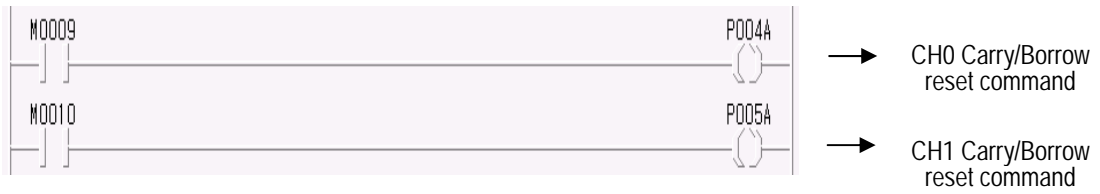

7.2.8 Supplementary functions

1) Count clear

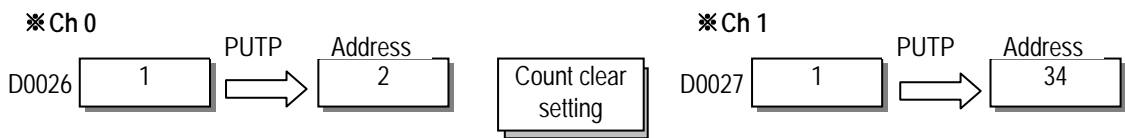
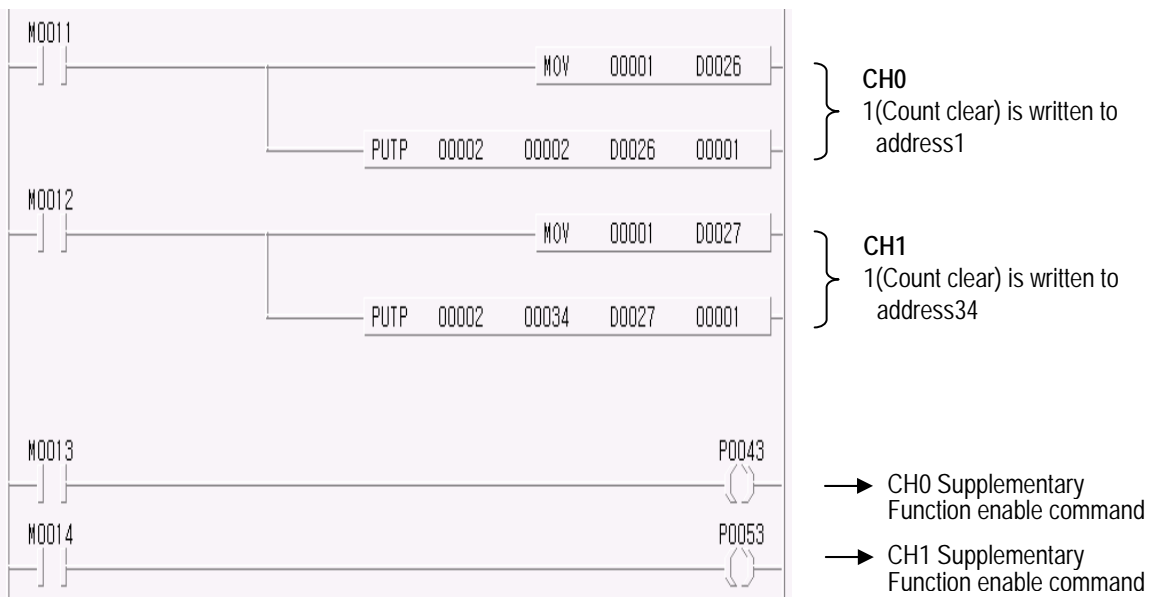

2) Count latch

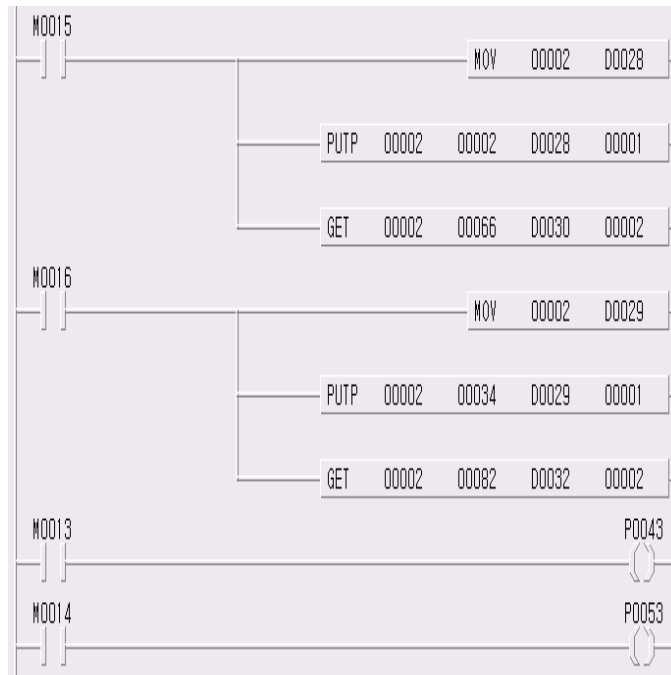

CH0
 1.2(Count latch) is written to address 2
 2.Count latch value is read from address 66.

CH1
 1. 2(Count latch) is written to address 34
 2. Count latch value is read from address 82.

→ CH0 Supplementary enable command
 → CH1 Supplementary enable command

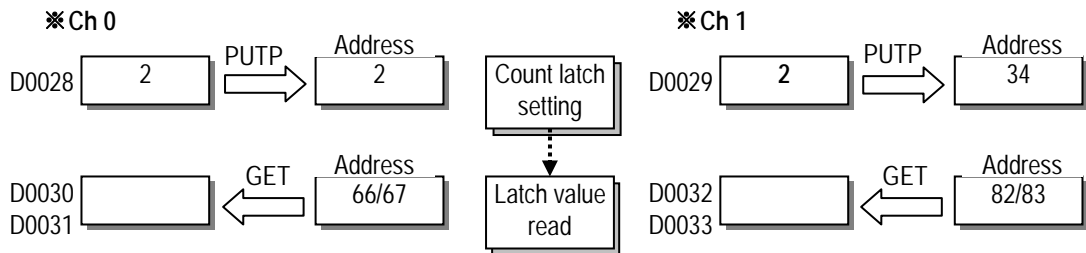

3) Sampling count

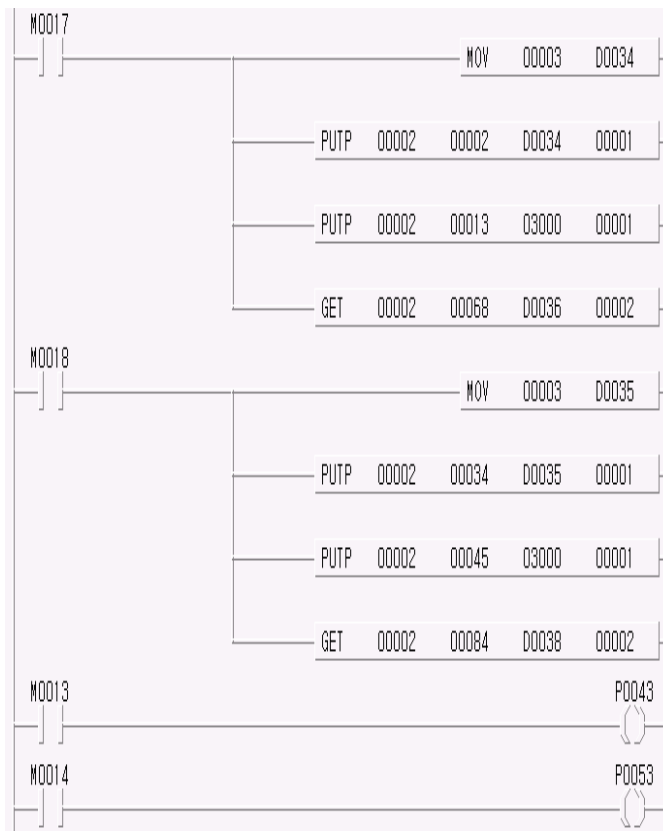

CH0
 1.3(Sampling count) is written to address 2.
 2.3000(ms) is written to address13.
 3.Sampling count value is read from address 68.

CH1
 1.3(Sampling count) is written to address 34.
 2.3000(ms) is written to address35.
 3.Sampling count value is read from address 68.

→ CH0 Supplementary function enable command
 → CH1 Supplementary function enable command

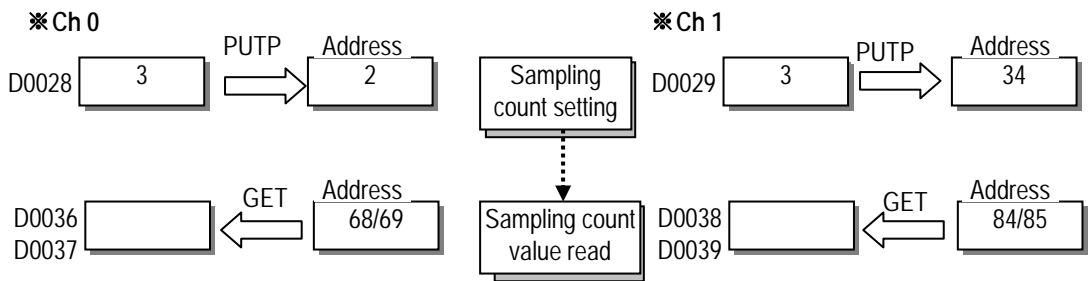

4) Pulse frequency count

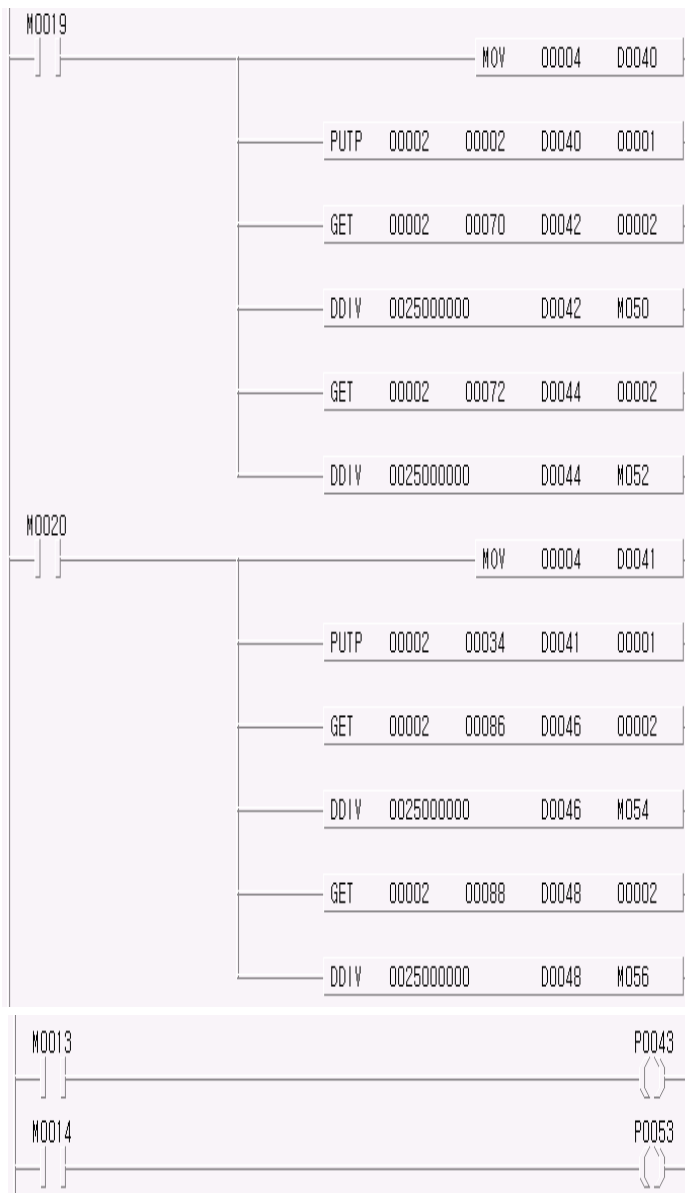

- CH0**
1. 4(Pulse frequency count) is written to address 2.
 2. Phase A clock is read from address 70.
 3. Phase A clock is converted to the cycle.
 4. Phase B clock is read from address 72.
 5. Phase B clock is converted to the cycle.

- CH1**
1. 4(Pulse frequency count) is written to address 34.
 2. Phase A clock is read from address 86.
 3. Phase A clock is converted to the cycle.
 4. Phase B clock is read from address 88.
 5. Phase B clock is converted to the cycle.

→ CH0 Supplementary function enable command
 → CH1 CH0 Supplementary function enable command

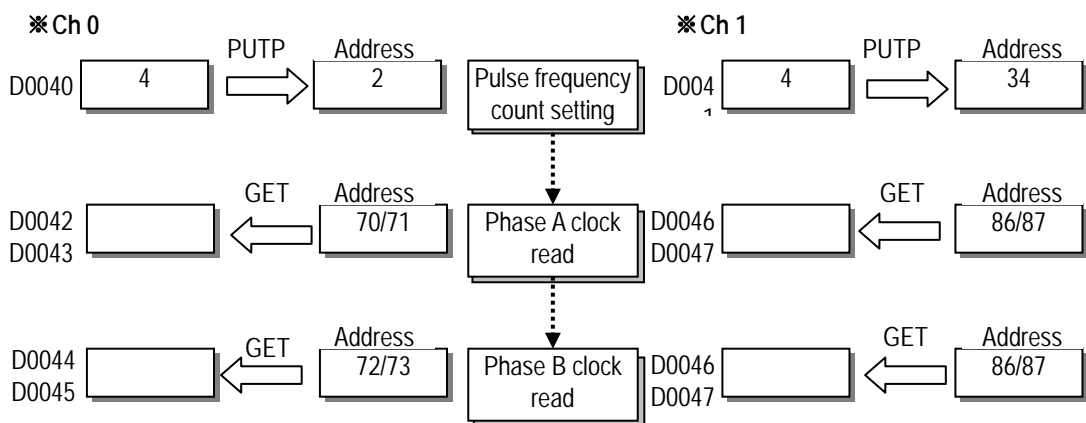

5) Periodic pulse count

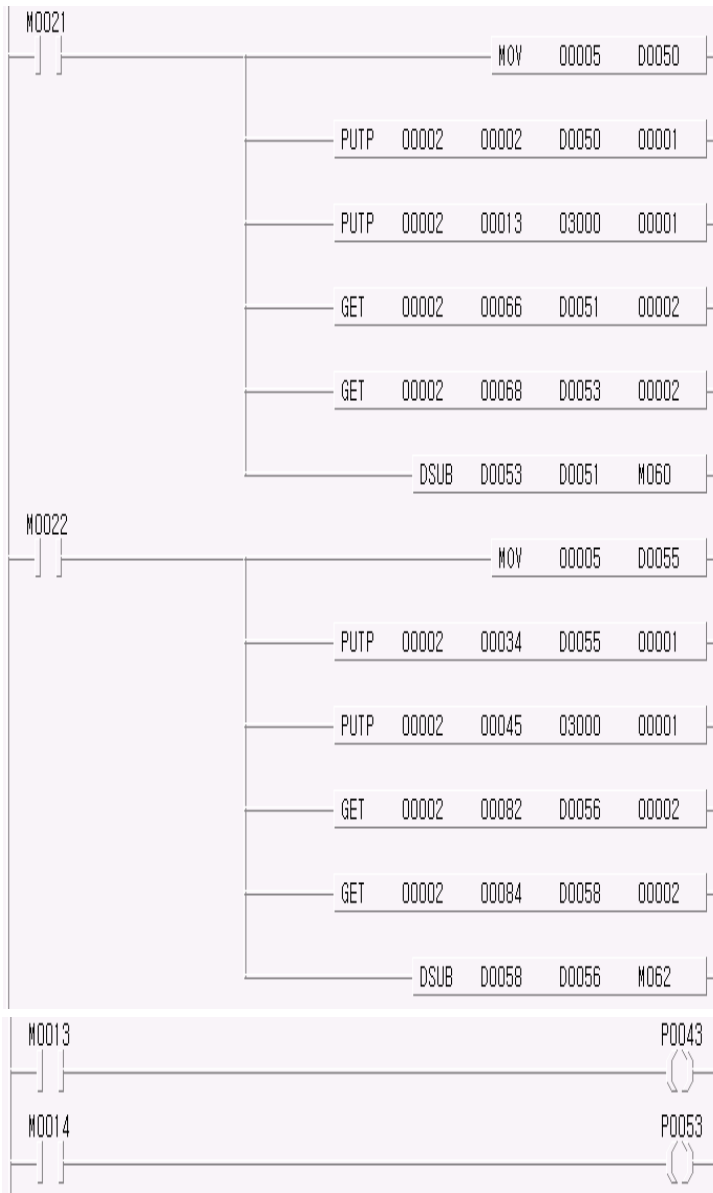

- CH0**
- 1.5(Periodic pulse count) is written to address 2
 - 3000(ms) is written to address 3.
 - Previous count value is read from address 66.
 - Current count value is read from address 68.
 - Current value-Previous value = Periodic pulse count value

- CH1**
- 5(Periodic pulse count) is written to address 34.
 - 3000(ms) is written to address 45
 - Previous count value is read from address 82.
 - Current count value is read from address 84.
 - Current value-Previous value = Periodic pulse count value

- CH0 Supplementary function enable command
- CH1 Supplementary function enable command

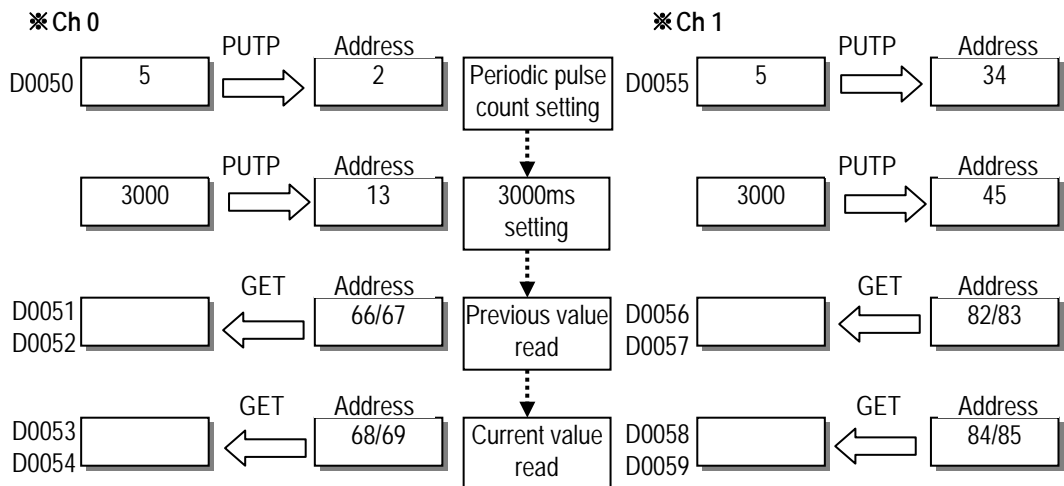

7.3 Application example

7.3.1 Cart moving program

■ System configuration

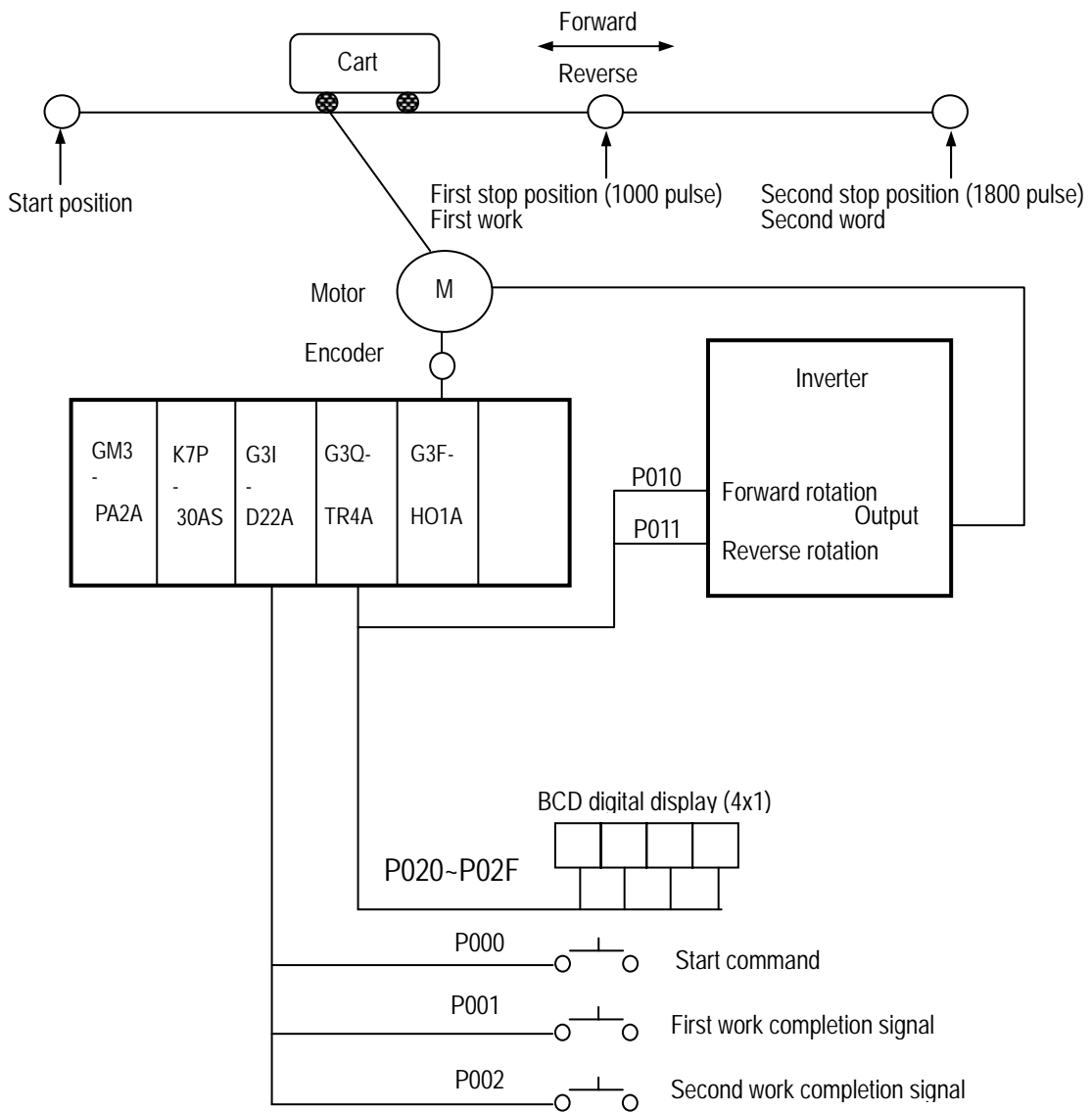

■ Operation explanation

The motor for moving the cart rotates with start command, and makes the cart stop at the first stop position with the High Speed Counter Module counting the encoder signals from the motor.

Then, if the first work complete signal turns On, the motor moves the cart to stop at the second stop position. When the second work complete signal turns On, the motor return the cart to the start position.

■ Input/Output Signal Allocation

P000 : Start Command
P001 : 1st Work Completion Signal
P002 : 2nd Work Completion Signal

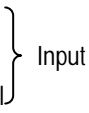

P010 : Motor forward rotation signal (On : Forward rotation , Off : Stop)
P011 : Motor reverse rotation Signal (On : Reverse rotation, Off : Stop)
P020~P02F : Indicates the current count value(BCD) of the High Speed Counter Module

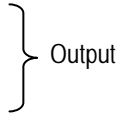

P030~P04F : High-speed counter Input Signal
P050~P06F : High-speed counter Output Signal

■ D Register Allocation

D0000~D0001 : High-speed counter Current count Value

■ Operation pattern

*1. 100(Difference between stop position and speed reducing position) is an interval delayed by reducing timing of the inverter.

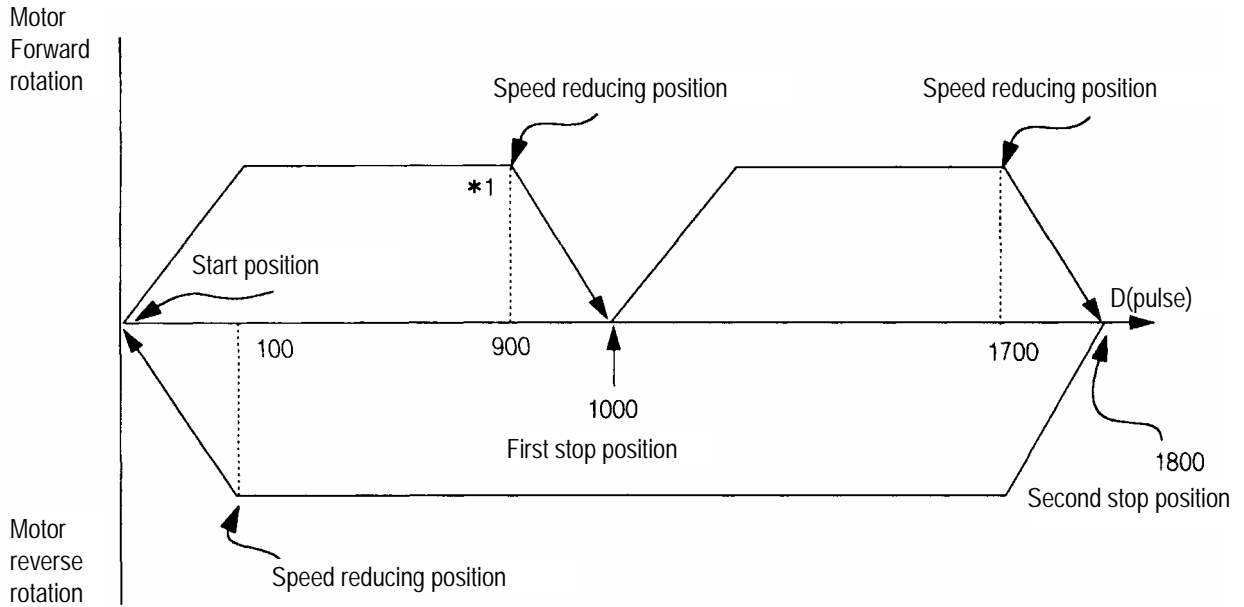

■ Operation timing Diagram

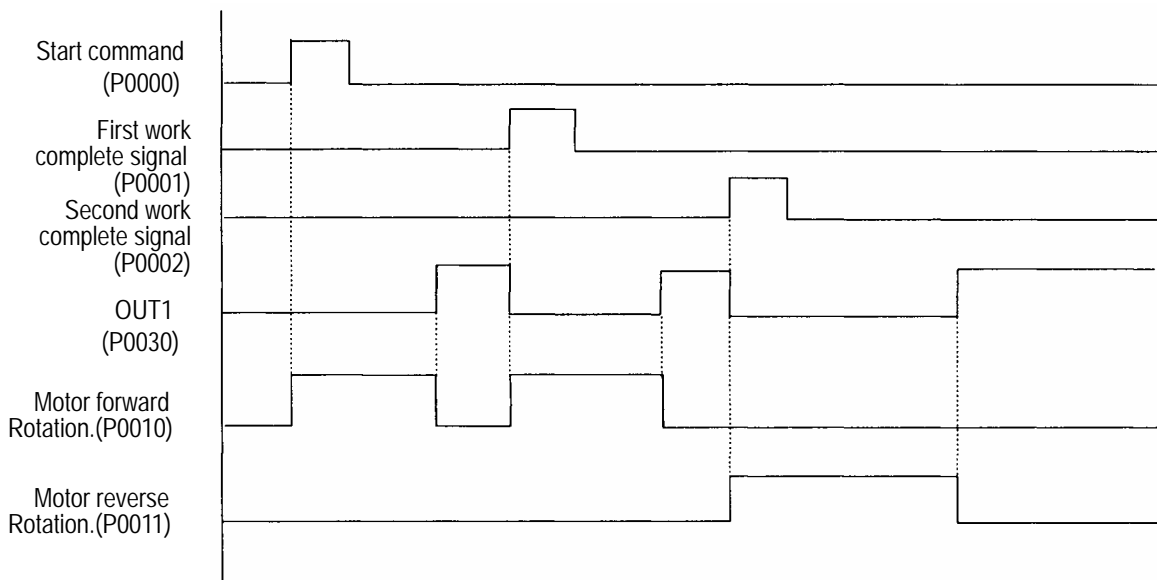

■ Program

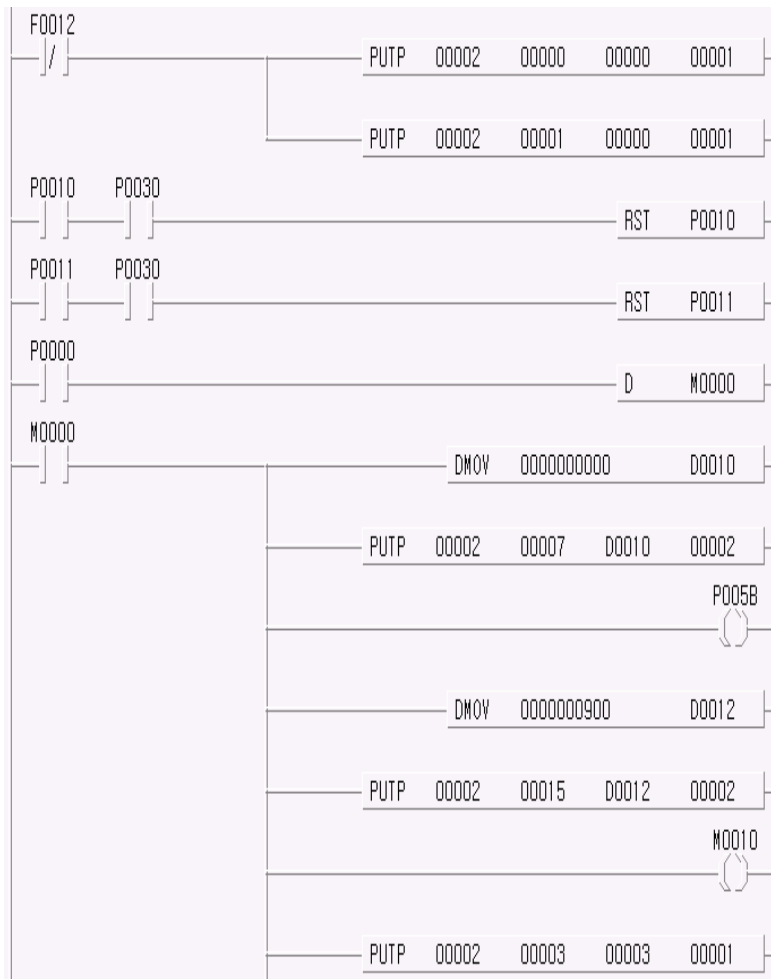

2Phase multiple of 2 setting

Linear count setting

After passing the speed reducing position, the forwardly rotating motor stops
After passing the speed reducing position, the reversely rotating motor stops

Start

} Start position initial value=0
(Preset setting)

External preset input enable

} Comparing value for stopping the first work=900

SET signal auxiliary output

OUT0 : " > "

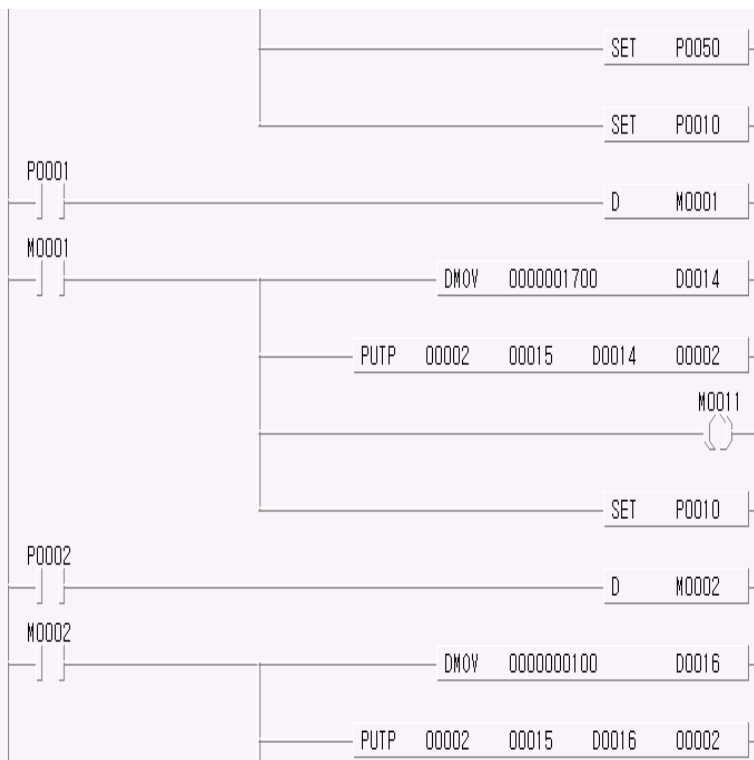

Count enable signal

The signal for motor's forward rotation

} Comparing value for stopping the first work=1700

SET signal auxiliary output

} Comparing value for stopping the start position=100

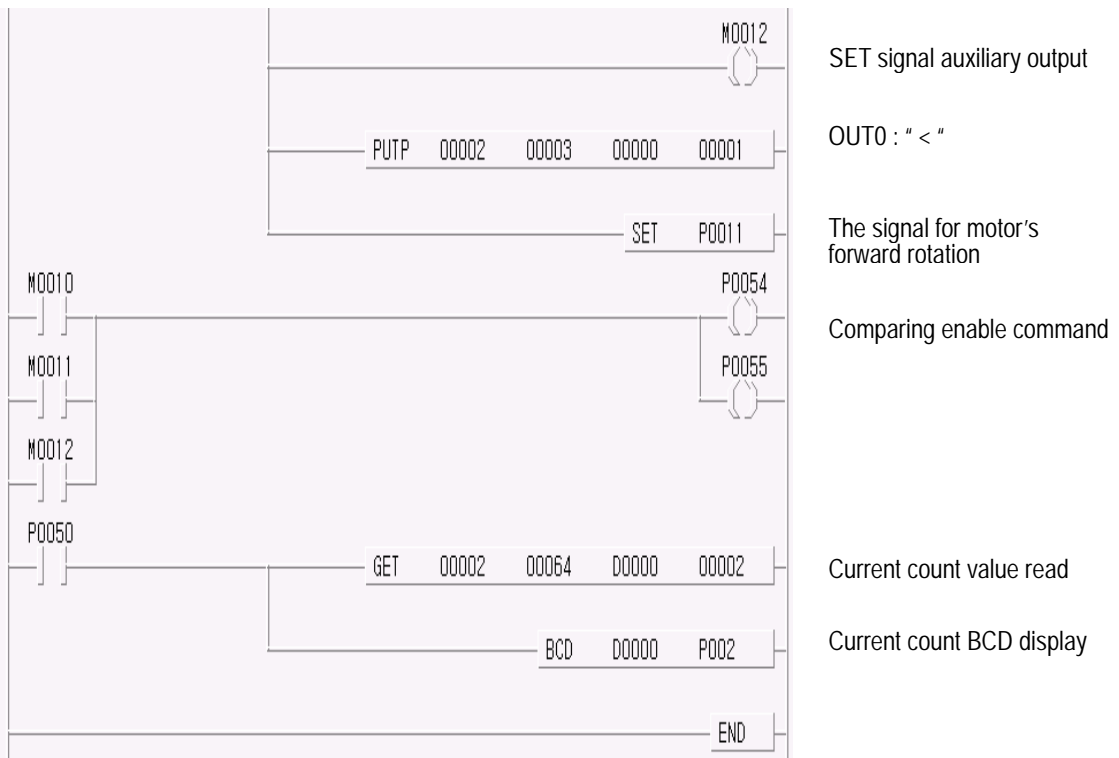

7.3.2 Program for Control of the Constant Angle rotation of the Turntable.

■ System configuration

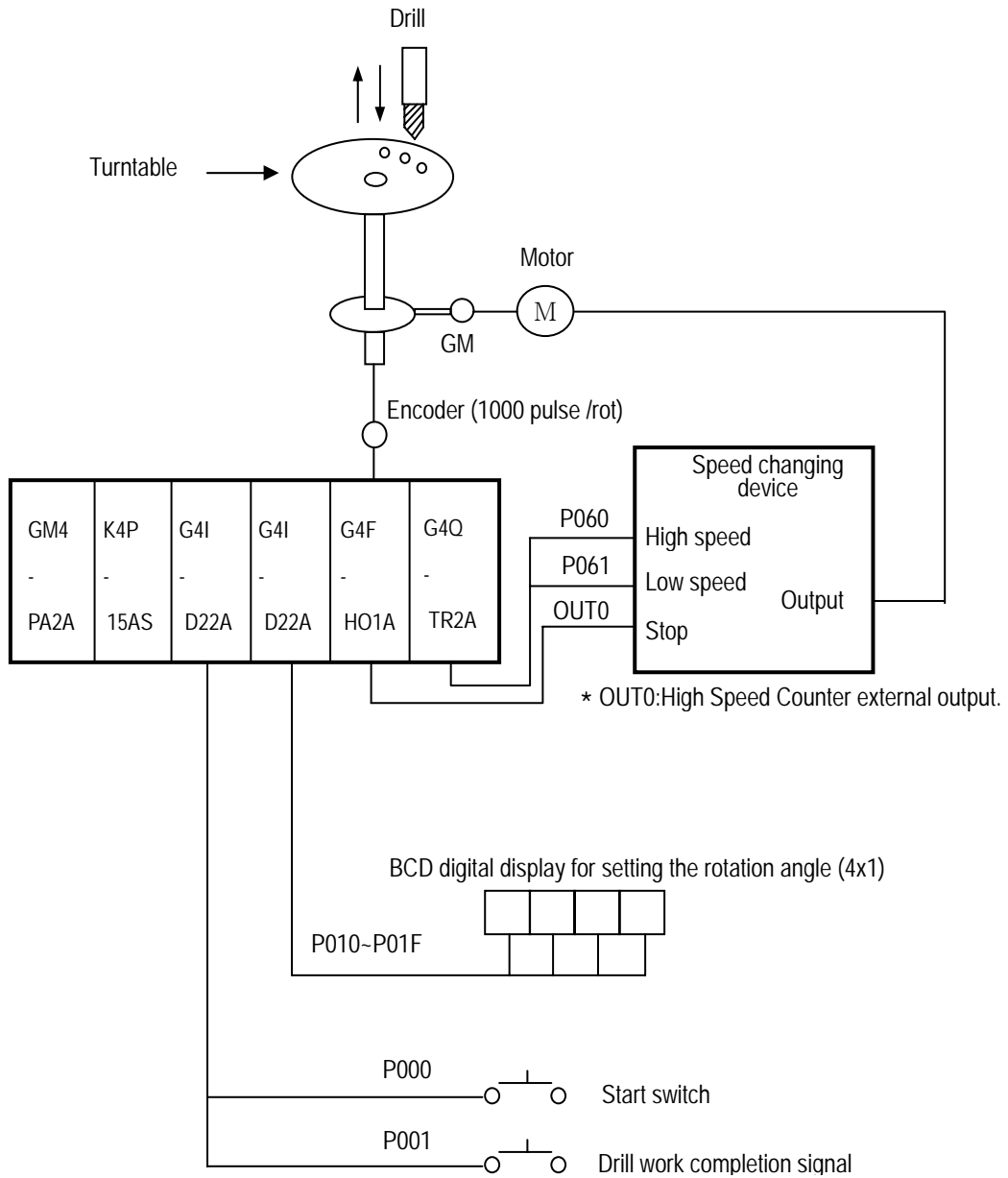

K4P-15AS : MK300S CPU

G4I-D22A : DC input Module (16 points)

G4F-HO1A : High speed counter Module (64 points)

G4Q-TR2A : TR output Module (16 points)

■ Operation Description

If the start switch is pushed, the turntable rotates as much as the rotation angle set (60°) and completes drilling.

If the drilling work completion signal turns On, it rotates again 60°. If repeating the above operations has finished six drilling works, all processing will be finished.

■ Operation Format

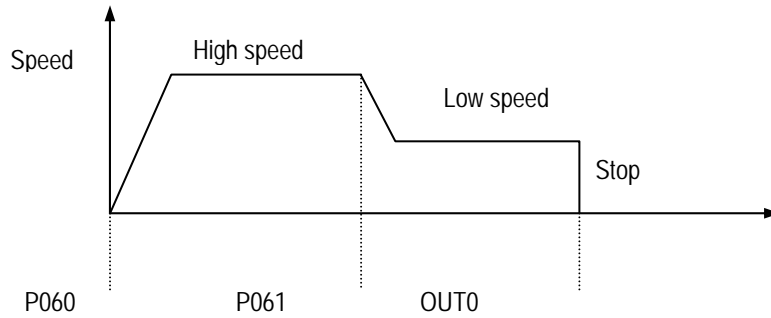

■ Program

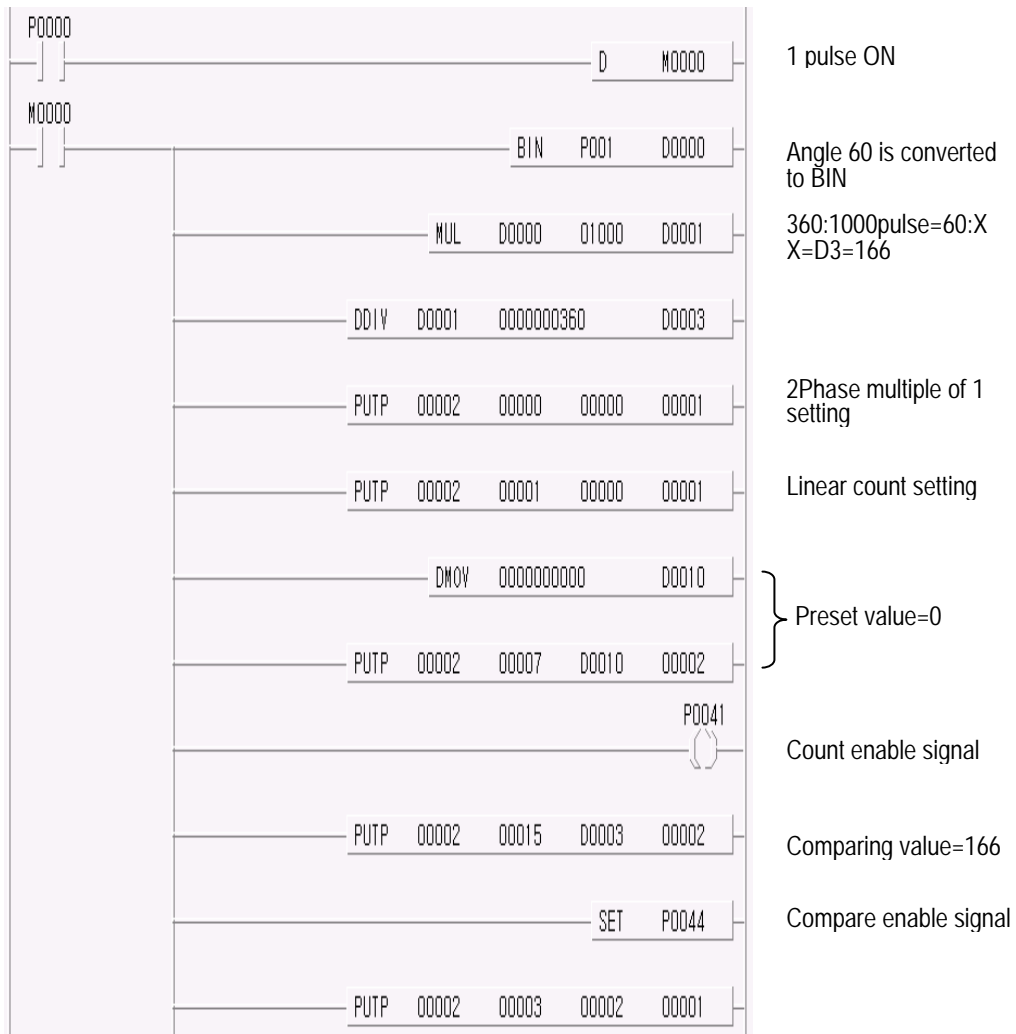

Chapter 7 MK Programming

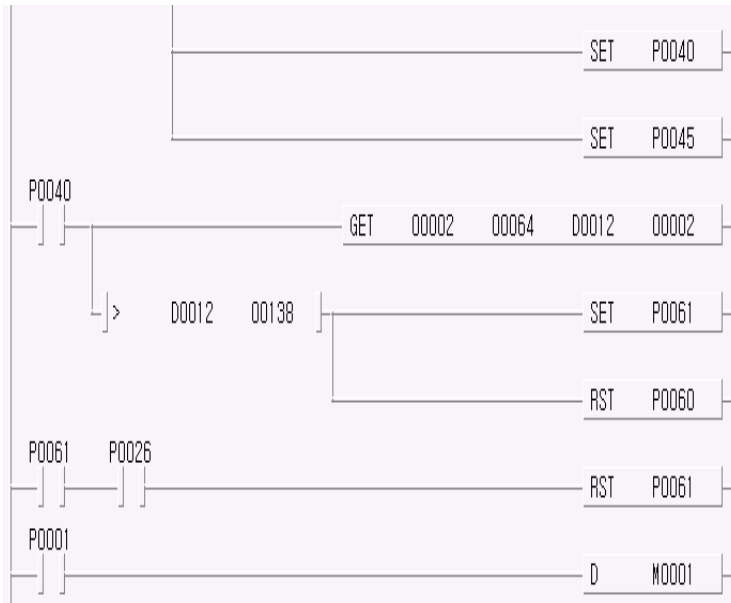

Count value is transferred to D0010,D0012

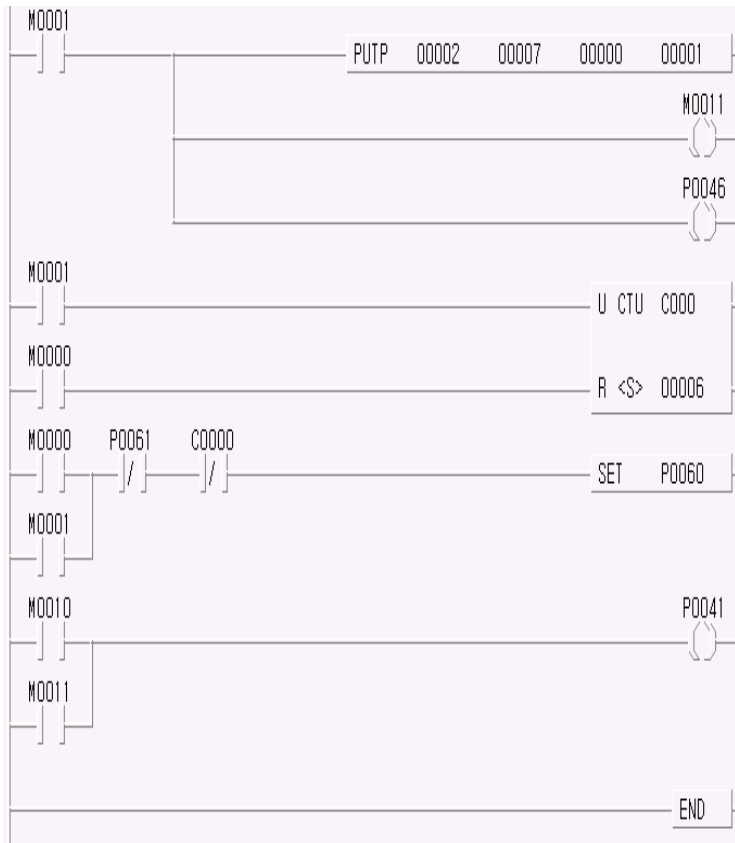

Chapter 8 Troubleshooting

- ▷ The following explains troubles and corrections when using the High Speed Count Module.
For troubleshooting relating to the CPU module, refer to the CPU module user's manual.

8.1 Troubleshooting

8.1.1 The LED status of High Speed Counter Module

PWR LED is turned off  See Section 8.2.1

8.1.2 The counting status of High Speed Counter Module

No changes of count value  See Section 8.2.2

Changes of count value do not conform to the operation status.  See Section 8.2.3

8.1.3 The output status of High Speed Counter Module

Output is not executed.  See Section 8.2.4

Output does not match with the operation status.

8.2 Troubleshooting Procedure

8.2.1 Incorrect LED status

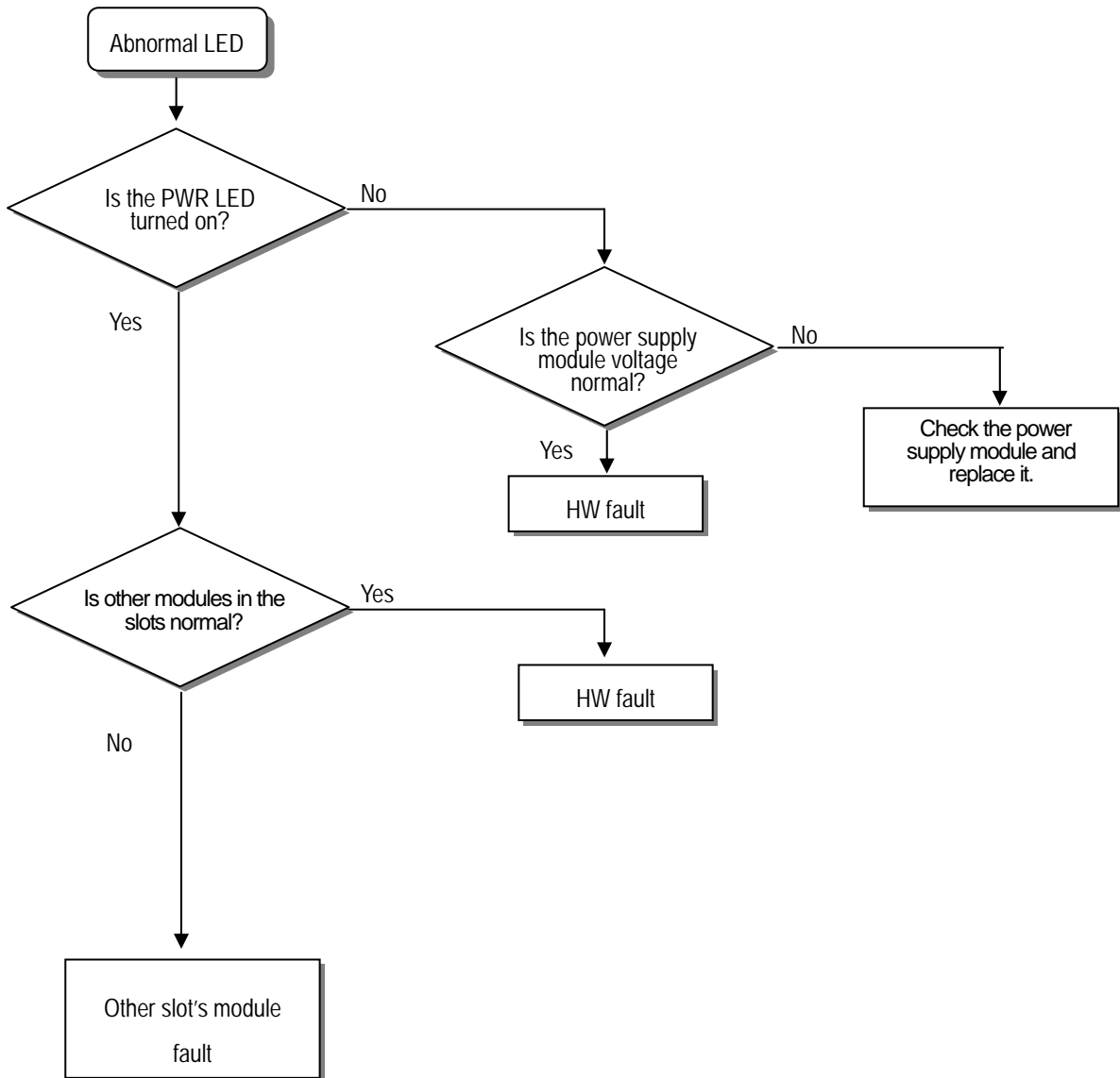

8.2.2 Abnormal count operation

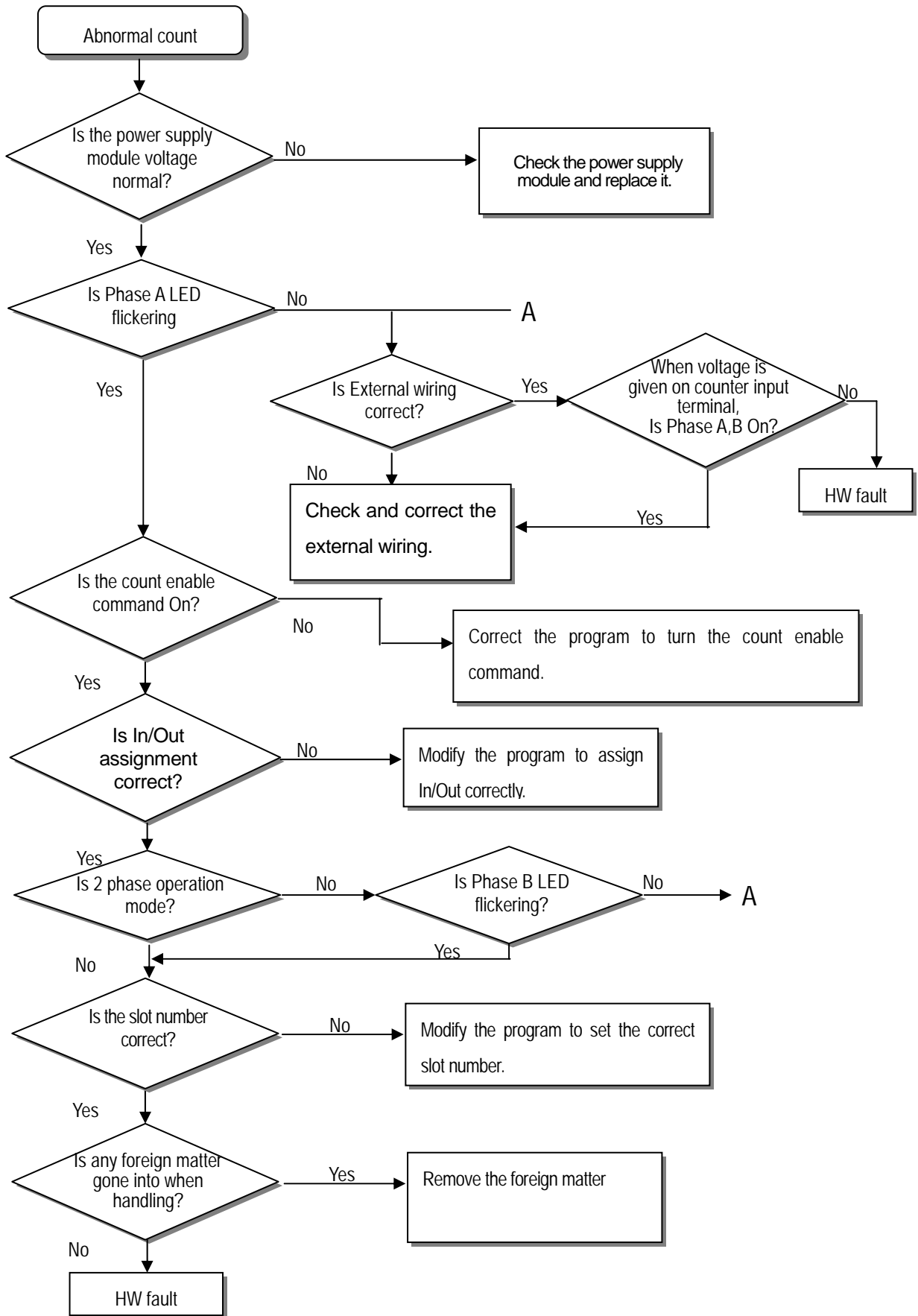

8.2.3 Abnormal count value

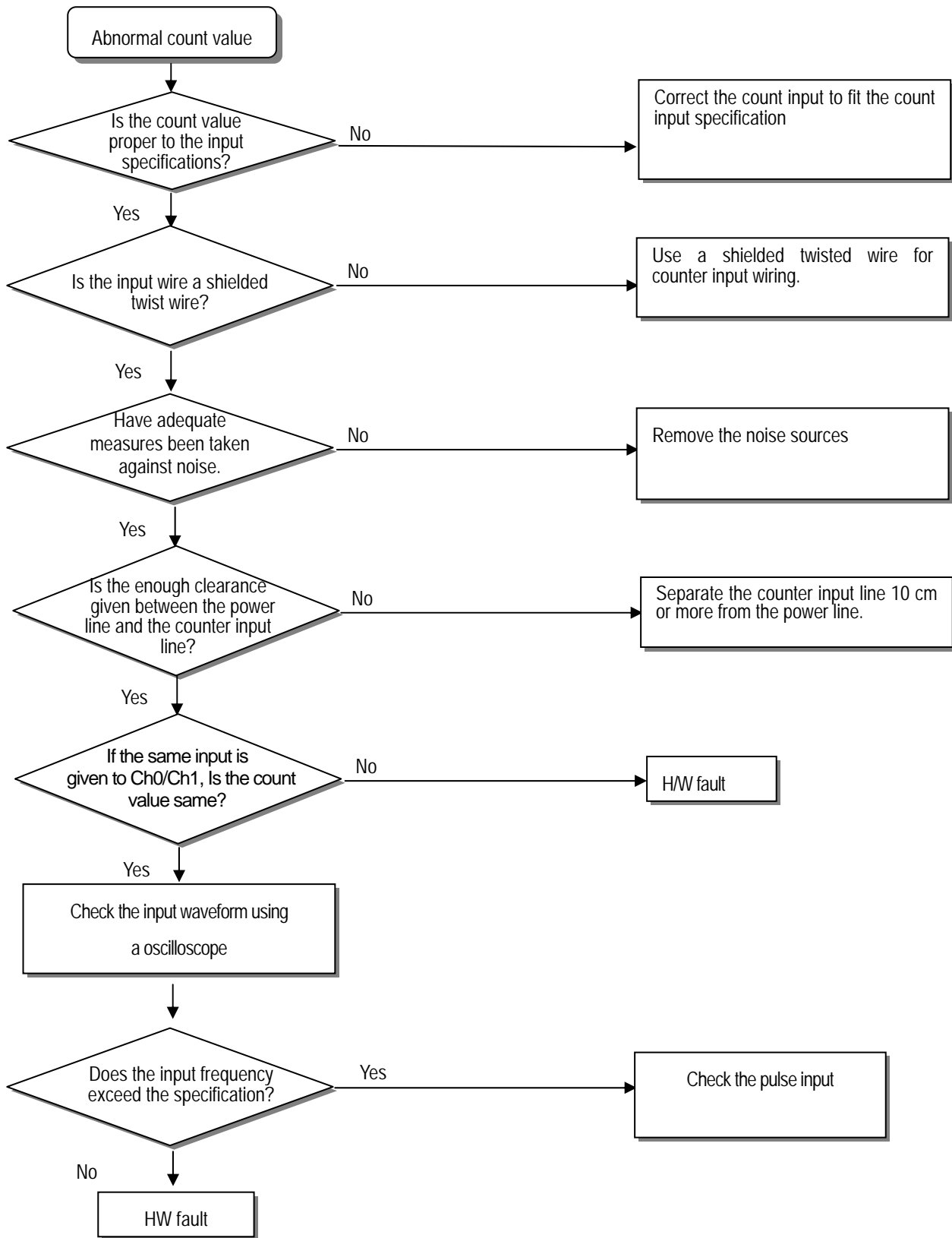

8.2.4 Abnormal output

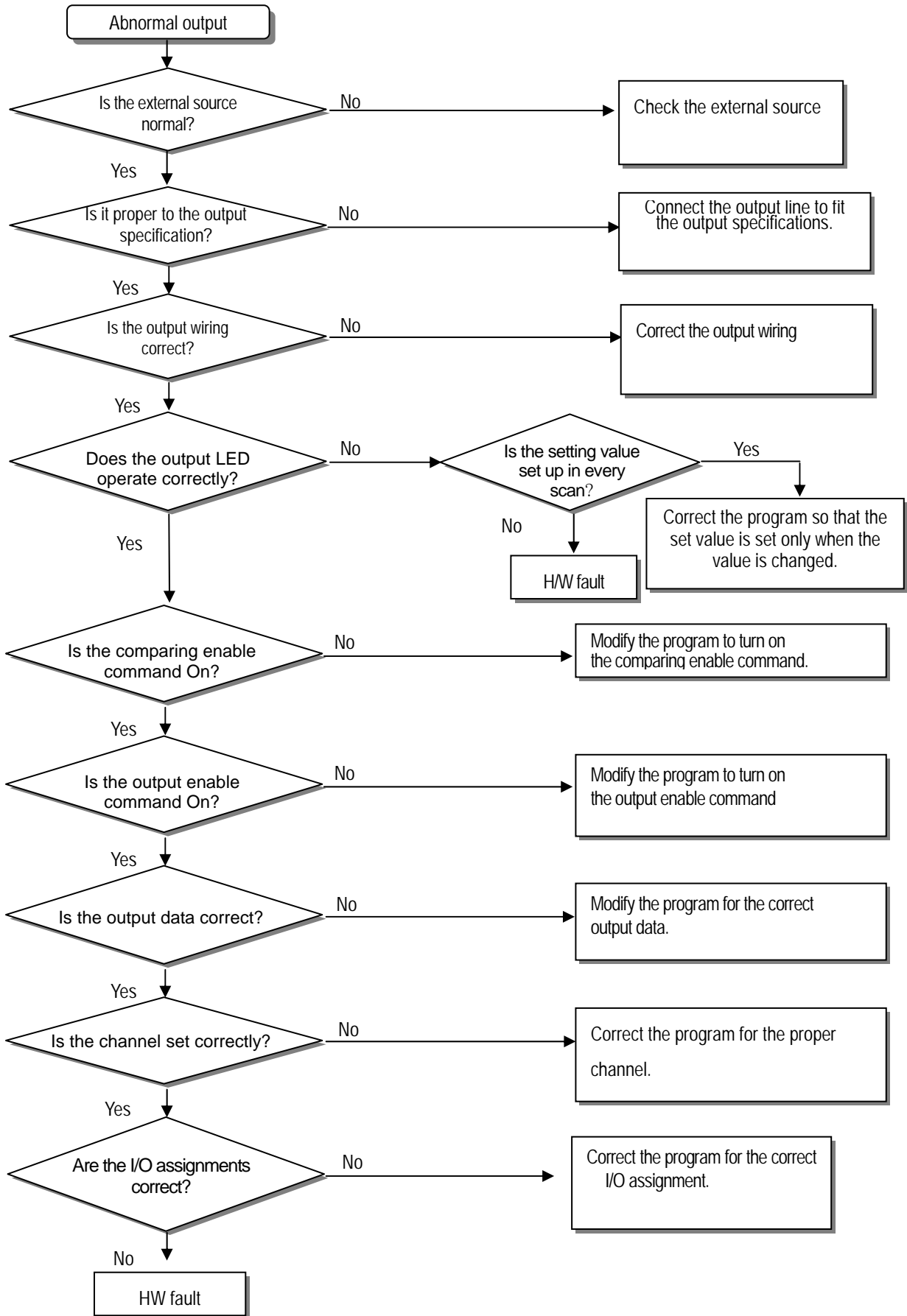

Index

- I*
- 1 Phase2-7
 - 1 phase multiple of 12-7, 2-8
 - 1 phase multiple of 22-7, 2-8
- 2*
- 2 phase multiple of 12-8
 - 2 phase multiple of 22-9
 - 2 phase multiple of 42-9
- A*
- arry2-17
- B*
- Borrow2-17
 - Buffer memory6-1, 6-2
 - Buffer memory read7-1
 - Buffer memory write.....7-3
- C*
- CCW2-9
 - Coincidence output2-13
 - Coincidence output mode 02-13
 - Coincidence output mode 12-14
 - Coincidence output mode 22-14
 - Coincidence output mode 32-15
 - Coincidence output mode 42-15
 - Coincidence output mode 52-16
 - Coincidence output mode 62-16
 - Count Clear2-18,7-9
 - Coincidence output selection.....6-4
 - Count Latch2-19,7-10
 - CW2-9
 - Coincidence output function block4-9, 4-17
 - Carry/Borrow reset7-9
 - Coincidence output selection and setting7-8
 - Count enable7-6
 - Count mode selection7-6
 - Count reading7-7
- D*
- DC12V NPN Open collector type 3-3
 - DC24V PNP Open collector type 3-4
 - DC5V Output type 3-2
- F*
- Function setting function block4-4, 4-12
 - Function selection 6-3
- G*
- GET/GETP 7-1
 - GET/GETP command configuration 7-1
- I*
- Input/Output signal 6-5
- L*
- Linear count.....2-10
 - Line driver type..... 3-5
 - Linear/Ring count selection 7-5
- O*
- Operating information reading function block.....4-8, 4-16
 - Operating information writing function block4-7, 4-15
- P*
- Periodic pulse count2-22,7-13
 - Pulse frequency count.....2-21,7-12
 - Pulse input modes 2-7
 - Preset setting function block 4-2, 4-10
 - Preset enable 7-7
 - PUT/PUTP..... 7-3
 - PUT/PUTP command configuration 7-3

Index

R

Ring count	2-10
Ring/Linear count selection	6-3

S

Sampling Count	2-20,7-11
Status display	6-4
Supplementary functions	7-9