



Page 13-2

MINIATURE CIRCUIT BREAKERS UP TO 63A

- 1P, 1P+N, 2P, 3P and 4P versions
- IEC rated current I_n : 1...63A
- IEC short-circuit breaking capacity I_{cn} : 10kA (6kA for 1P+N)
- Trip characteristic curve: Type B, C, D
- UL 1077 or UL 489 certified versions.



Page 13-10

MINIATURE CIRCUIT BREAKERS 80...125A

- 1P, 2P, 3P and 4P versions
- IEC rated current I_n : 80...125A
- IEC short-circuit breaking capacity I_{cn} : 10kA
- Trip characteristic curve: Type C, D
- UL 1077 certified versions.



Page 13-11

ADD-ON BLOCKS AND ACCESSORIES

- Auxiliary and indicator contacts
- Undervoltage trip releases
- Shunt trip releases
- Connection accessories
- UL 1077 or UL 489 certified versions
- Modular 16A socket.



Page 13-12

RESIDUAL BLOCKS FOR CIRCUIT BREAKERS UP TO 63A

- 2P, 3P and 4P versions
- IEC rated current I_n : 40 and 63A
- Residual current: 30 and 300mA
- Residual current operating characteristic: Type A.



Page 13-12

RESIDUAL CURRENT OPERATED CIRCUIT BREAKERS 25...63A

- 2P and 4P versions
- IEC rated current I_n : 25, 40 and 63A
- IEC rated residual operating current $I_{\Delta n}$: 30mA and 300mA
- Residual current operating characteristic: Type A, B and AC.



Page 13-13

RESIDUAL CURRENT OPERATED CIRCUIT BREAKERS WITH OVERCURRENT PROTECTION UP TO 40A

- 1P+N versions
- IEC rated current I_n : 6...40A
- IEC rated short-circuit capacity I_{cn} : 10kA
- Trip characteristic curve: Type C
- Residual current: 30 and 300mA
- Residual current operating characteristic: Type AC and A.



- UL 1077 and UL 489 certified versions
- High breaking capacity
- Various trip characteristic curves: Type B, C or D
- Wide 1...125A current range
- Residuals with trip characteristic curves type A, AC and B
- Accessories available.

Miniature circuit breakers 1...63A, UL 1077

	SEC. - PAGE
1P - 10kA, 1 module, curve types B, C and D	13 - 2
1P+N - 6kA, 1 module, curve type C	13 - 3
1P+N - 6kA, 2 modules, curve type C	13 - 3
2P - 10kA, 2 modules, curve types B, C and D	13 - 4
3P - 10kA, 3 modules, curve types B, C and D	13 - 5
4P - 10kA, 4 modules, curve types B, C and D	13 - 6

Miniature circuit breakers 1...63A, UL 489

1P - 10kA, 1 module	13 - 7
2P - 10kA, 2 modules	13 - 8
3P - 10kA, 3 modules	13 - 9

Miniature circuit breakers 80...125A, UL 1077

1P, 2P, 3P and 4P - 10kA, curve type C	13 - 10
3P and 4P - 10kA, curve type D	13 - 10

Add-on blocks and accessories	13 - 11
--------------------------------------------	----------------

Residual blocks	13 - 12
------------------------------	----------------

Residual current operated circuit breakers	13 - 12
---------------------------------------------------------	----------------

Residual current operated circuit breakers with overcurrent protection	13 - 13
-------------------------------------------------------------------------------------	----------------

Dimensions	13 - 14
-------------------------	----------------

Wiring diagrams	13 - 14
------------------------------	----------------

Technical characteristics	13 - 15
----------------------------------------	----------------

1P - 10kA 1 module



P1 MB 1P...



Order code	Curve	IEC In	IEC Icn	N° of DIN module	Qty per pkg	Wt
	Type	[A]	[kA]	n°	n°	[kg]

Single pole, thermal and magnetic trip type, B-curve characteristic.

P1 MB 1P B01	B	1	10	1	12	0.115
P1 MB 1P B02	B	2	10	1	12	0.115
P1 MB 1P B04	B	4	10	1	12	0.115
P1 MB 1P B06	B	6	10	1	12	0.115
P1 MB 1P B10	B	10	10	1	12	0.115
P1 MB 1P B13	B	13	10	1	12	0.115
P1 MB 1P B16	B	16	10	1	12	0.115
P1 MB 1P B20	B	20	10	1	12	0.115
P1 MB 1P B25	B	25	10	1	12	0.115
P1 MB 1P B32	B	32	10	1	12	0.115
P1 MB 1P B40	B	40	10	1	12	0.115
P1 MB 1P B50	B	50	10	1	12	0.115
P1 MB 1P B63	B	63	10	1	12	0.115

Single pole, thermal and magnetic trip type, C-curve characteristic.

P1 MB 1P C01	C	1	10	1	12	0.115
P1 MB 1P C02	C	2	10	1	12	0.115
P1 MB 1P C04	C	4	10	1	12	0.115
P1 MB 1P C06	C	6	10	1	12	0.115
P1 MB 1P C10	C	10	10	1	12	0.115
P1 MB 1P C13	C	13	10	1	12	0.115
P1 MB 1P C16	C	16	10	1	12	0.115
P1 MB 1P C20	C	20	10	1	12	0.115
P1 MB 1P C25	C	25	10	1	12	0.115
P1 MB 1P C32	C	32	10	1	12	0.115
P1 MB 1P C40	C	40	10	1	12	0.115
P1 MB 1P C50	C	50	10	1	12	0.115
P1 MB 1P C63	C	63	10	1	12	0.115

Single pole, thermal and magnetic trip type, D-curve characteristic.

P1 MB 1P D01	D	1	10	1	12	0.115
P1 MB 1P D02	D	2	10	1	12	0.115
P1 MB 1P D04	D	4	10	1	12	0.115
P1 MB 1P D06	D	6	10	1	12	0.115
P1 MB 1P D10	D	10	10	1	12	0.115
P1 MB 1P D13	D	13	10	1	12	0.115
P1 MB 1P D16	D	16	10	1	12	0.115
P1 MB 1P D20	D	20	10	1	12	0.115
P1 MB 1P D25	D	25	10	1	12	0.115
P1 MB 1P D32	D	32	10	1	12	0.115
P1 MB 1P D40	D	40	10	1	12	0.115
P1 MB 1P D50	D	50	10	1	12	0.115
P1 MB 1P D63	D	63	10	1	12	0.115

General characteristics

These devices are used to protect against short circuits and overloads of wiring installations and loads in panel boards, office buildings, stores and similar applications. Their purpose is circuit protection, circuit isolation and load operation controls. They have instantaneous trip characteristics defined as follows:

- B-curve: instantaneous trip 3...5 times I_n for non-inductive or low inductive loads (heating resistors, generators, very long wire lines)
- C-curve: instantaneous trip 5...10 times I_n for inductive loads (mixed and inductive resistive loads with low inrush current)
- D-curve: instantaneous trip 10...14 times I_n for highly inductive loads (loads with high inrush and current such as motors).

Main features include:

- IEC rated current I_n : 1...63A
- Pole width: 17.5mm / 0.69"
- Contact status with flag indicator
- Trip characteristic: Curve type B, C and D
- Auxiliary contacts and trip releases mounted on MCB left side
- Fixing on 35mm DIN rail (IEC/EN 60715).

Operational characteristics

- Dissipation per pole: 3...13W
- IEC rated insulation voltage U_i : 440V
- IEC rated impulse voltage U_{imp} : 4kV
- IEC rated operational voltage U_e : 230/400VAC.

Certifications and compliance

Certifications obtained: TÜV – Rheinland; UL Recognized for USA and Canada (cURus – File E359585) as "Supplementary Protectors", designated as Overcurrent type, for general industrial use, suitable for factory wiring only with 125-135% tripping current of amp rating. Products having this type of marking are intended for use as components of complete workshop- assembled equipment.

Compliant with standards: IEC/EN 60898-1, IEC/EN 60947-2, UL 1077, CSA C22.2 n°235.

1P+N - 6kA 1 module



P1 MB 1M...

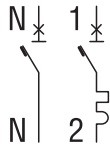

Order code	Curve	IEC In	IEC Icn	N° of DIN module	Qty per pkg	Wt
	Type	[A]	[kA]	n°	n°	[kg]

Single pole + neutral, thermal and magnetic trip type, B-curve characteristic.

P1 MB 1M B06	B	6	6	1	12	0.115
P1 MB 1M B10	B	10	6	1	12	0.115
P1 MB 1M B16	B	16	6	1	12	0.115
P1 MB 1M B20	B	20	6	1	12	0.115
P1 MB 1M B25	B	25	6	1	12	0.115
P1 MB 1M B32	B	32	6	1	12	0.115

Single pole + neutral, thermal and magnetic trip type, C-curve characteristic.

P1 MB 1M C02	C	2	6	1	12	0.115
P1 MB 1M C04	C	4	6	1	12	0.115
P1 MB 1M C06	C	6	6	1	12	0.115
P1 MB 1M C10	C	10	6	1	12	0.115
P1 MB 1M C13	C	13	6	1	12	0.115
P1 MB 1M C16	C	16	6	1	12	0.115
P1 MB 1M C20	C	20	6	1	12	0.115
P1 MB 1M C25	C	25	6	1	12	0.115
P1 MB 1M C32	C	32	6	1	12	0.115
P1 MB 1M C40	C	40	6	1	12	0.115

General characteristics

These devices are used to protect against short circuits and overloads of wiring installations and loads in panel boards, office buildings, stores and similar applications. Their purpose is circuit protection, circuit isolation and load operation controls. They have characteristics of instantaneous trip defined as follows:

- B-curve: instantaneous trip 3...5 times I_n for non-inductive or low inductive loads (heating resistors, generators, very long wire lines)
- C-curve: instantaneous trip 5...10 times I_n for inductive loads (mixed loads, resistive and inductive with low inrush current)
- D-curve: instantaneous trip 10...14 times I_n for highly inductive loads (loads with high inrush and current such as motors).

Main features include:

- IEC rated current I_n : 2...40A
- Pole width: 9mm/0.35" (0.5 module)
- Contact status with flag indicator
- Trip characteristic: Curve type B and C
- Auxiliary contacts and trip releases mounted on left side
- Fixing on 35mm DIN rail (IEC/EN 60715).

Operational characteristics

- Dissipation per pole: 3...7.5W
- IEC rated insulation voltage U_i : 440V
- IEC rated impulse voltage U_{imp} : 4kV
- IE rated operational voltage U_e : 230VAC.

Certifications and compliance

Certifications obtained: TÜV Rheinland.
Compliant with standards: IEC/EN 60898-1, IEC/EN 60947-2.

1P+N - 6kA 2 modules



P1 MB 1N...



Order code	Curve	IEC In	IEC Icn	N° of DIN module	Qty per pkg	Wt
	Type	[A]	[kA]	no.	n°	[kg]

Single pole + neutral, thermal and magnetic trip type, C-curve characteristic.

P1 MB 1N C01	C	1	6	2	6	0.190
P1 MB 1N C02	C	2	6	2	6	0.190
P1 MB 1N C04	C	4	6	2	6	0.190
P1 MB 1N C06	C	6	6	2	6	0.190
P1 MB 1N C10	C	10	6	2	6	0.190
P1 MB 1N C16	C	16	6	2	6	0.190
P1 MB 1N C20	C	20	6	2	6	0.190
P1 MB 1N C25	C	25	6	2	6	0.190
P1 MB 1N C32	C	32	6	2	6	0.190
P1 MB 1N C40	C	40	6	2	6	0.190
P1 MB 1N C50	C	50	6	2	6	0.190
P1 MB 1N C63	C	63	6	2	6	0.190

General characteristics

- IEC rated current I_n : 1...63A
- Pole width: 17.5mm / 0.69"
- Contact status with flag indicator
- Trip characteristic: Curve type C
- Auxiliary contacts and trip releases mounted on left side
- Fixing on 35mm DIN rail (IEC/EN 60715).

Operational characteristics

- Dissipation per pole: 3...13W
- IEC rated insulation voltage U_i : 440V
- IEC rated impulse voltage U_{imp} : 4kV
- IEC rated operational voltage U_e : 230/400VAC.

Certifications and compliance

Certifications obtained: TÜV Rheinland.
Compliant with standards: IEC/EN 60898-1, IEC/EN 60947-2.

2P - 10kA 2 modules



P1 MB 2P...

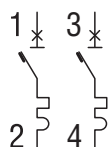

Order code	Curve	IEC In	IEC Icn	N° of DIN module	Qty per pkg	Wt
	Type	[A]	[kA]	n°	n°	[kg]

Two pole, thermal and magnetic trip type, B-curve characteristic.

P1 MB 2P B01	B	1	10	2	6	0.230
P1 MB 2P B02	B	2	10	2	6	0.230
P1 MB 2P B04	B	4	10	2	6	0.230
P1 MB 2P B06	B	6	10	2	6	0.230
P1 MB 2P B10	B	10	10	2	6	0.230
P1 MB 2P B13	B	13	10	2	6	0.230
P1 MB 2P B16	B	16	10	2	6	0.230
P1 MB 2P B20	B	20	10	2	6	0.230
P1 MB 2P B25	B	25	10	2	6	0.230
P1 MB 2P B32	B	32	10	2	6	0.230
P1 MB 2P B40	B	40	10	2	6	0.230
P1 MB 2P B50	B	50	10	2	6	0.230
P1 MB 2P B63	B	63	10	2	6	0.230

Two pole, thermal and magnetic trip type, C-curve characteristic.

P1 MB 2P C01	C	1	10	2	6	0.230
P1 MB 2P C02	C	2	10	2	6	0.230
P1 MB 2P C04	C	4	10	2	6	0.230
P1 MB 2P C06	C	6	10	2	6	0.230
P1 MB 2P C10	C	10	10	2	6	0.230
P1 MB 2P C13	C	13	10	2	6	0.230
P1 MB 2P C16	C	16	10	2	6	0.230
P1 MB 2P C20	C	20	10	2	6	0.230
P1 MB 2P C25	C	25	10	2	6	0.230
P1 MB 2P C32	C	32	10	2	6	0.230
P1 MB 2P C40	C	40	10	2	6	0.230
P1 MB 2P C50	C	50	10	2	6	0.230
P1 MB 2P C63	C	63	10	2	6	0.230

Two pole, thermal and magnetic trip type, D-curve characteristic.

P1 MB 2P D01	D	1	10	2	6	0.230
P1 MB 2P D02	D	2	10	2	6	0.230
P1 MB 2P D04	D	4	10	2	6	0.230
P1 MB 2P D06	D	6	10	2	6	0.230
P1 MB 2P D10	D	10	10	2	6	0.230
P1 MB 2P D13	D	13	10	2	6	0.230
P1 MB 2P D16	D	16	10	2	6	0.230
P1 MB 2P D20	D	20	10	2	6	0.230
P1 MB 2P D25	D	25	10	2	6	0.230
P1 MB 2P D32	D	32	10	2	6	0.230
P1 MB 2P D40	D	40	10	2	6	0.230
P1 MB 2P D50	D	50	10	2	6	0.230
P1 MB 2P D63	D	63	10	2	6	0.230

General characteristics

These devices are used to protect against short circuits and overloads of wiring installations and loads in panel boards, office buildings, stores and similar applications. Their purpose is circuit protection, circuit isolation and load operation controls. They have characteristics of instantaneous trip defined as follows:

- B-curve: instantaneous trip 3...5 times In for non-inductive or low inductive loads (heating resistors, generators, very long wire lines)
- C-curve: instantaneous trip 5...10 times In for inductive loads (mixed loads, resistive and inductive with low inrush current)
- D-curve: instantaneous trip 10...14 times In for highly inductive loads (loads with high inrush and current such as motors).

Main features include:

- IEC rated current In: 1...63A
- Pole width: 17.5mm / 0.69"
- Contact status with flag indicator
- Trip characteristic: Curve type B, C and D
- Auxiliary contacts and trip releases mounted on left side
- Fixing on 35mm DIN rail (IEC/EN 60715).

Operational characteristics

- Dissipation per pole: 3...13W
- IEC rated insulation voltage Ui: 440V
- IEC rated impulse voltage Uimp: 4kV
- IEC rated operational voltage Ue: 230/400VAC.

Certifications and compliance

Certifications obtained: TÜV – Rheinland; UL Recognized for USA and Canada (cURus – File E359585) as "Supplementary Protectors", designated as Overcurrent type, for general industrial use, suitable for factory wiring only with 125-135% tripping current of amp rating. Products having this type of marking are intended for use as components of complete workshop- assembled equipment.

Compliant with standards: IEC/EN 60898-1, IEC/EN 60947-2, UL 1077, CSA C22.2 n°235.

3P - 10kA 3 modules



P1 MB 3P...

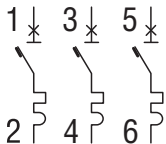

Order code	Curve	IEC In	IEC Icn	N° of DIN module	Qty per pkg	Wt
	Type	[A]	[kA]	n°	n°	[kg]

Three pole, thermal and magnetic trip type, B-curve characteristic.

P1 MB 3P B01	B	1	10	3	4	0.345
P1 MB 3P B02	B	2	10	3	4	0.345
P1 MB 3P B04	B	4	10	3	4	0.345
P1 MB 3P B06	B	6	10	3	4	0.345
P1 MB 3P B10	B	10	10	3	4	0.345
P1 MB 3P B13	B	13	10	3	4	0.345
P1 MB 3P B16	B	16	10	3	4	0.345
P1 MB 3P B20	B	20	10	3	4	0.345
P1 MB 3P B25	B	25	10	3	4	0.345
P1 MB 3P B32	B	32	10	3	4	0.345
P1 MB 3P B40	B	40	10	3	4	0.345
P1 MB 3P B50	B	50	10	3	4	0.345
P1 MB 3P B63	B	63	10	3	4	0.345

Three pole, thermal and magnetic trip type, C-curve characteristic.

P1 MB 3P C01	C	1	10	3	4	0.345
P1 MB 3P C02	C	2	10	3	4	0.345
P1 MB 3P C04	C	4	10	3	4	0.345
P1 MB 3P C06	C	6	10	3	4	0.345
P1 MB 3P C10	C	10	10	3	4	0.345
P1 MB 3P C13	C	13	10	3	4	0.345
P1 MB 3P C16	C	16	10	3	4	0.345
P1 MB 3P C20	C	20	10	3	4	0.345
P1 MB 3P C25	C	25	10	3	4	0.345
P1 MB 3P C32	C	32	10	3	4	0.345
P1 MB 3P C40	C	40	10	3	4	0.345
P1 MB 3P C50	C	50	10	3	4	0.345
P1 MB 3P C63	C	63	10	3	4	0.345

Three pole, thermal and magnetic trip type, D-curve characteristic.

P1 MB 3P D01	D	1	10	3	4	0.345
P1 MB 3P D02	D	2	10	3	4	0.345
P1 MB 3P D04	D	4	10	3	4	0.345
P1 MB 3P D06	D	6	10	3	4	0.345
P1 MB 3P D10	D	10	10	3	4	0.345
P1 MB 3P D13	D	13	10	3	4	0.345
P1 MB 3P D16	D	16	10	3	4	0.345
P1 MB 3P D20	D	20	10	3	4	0.345
P1 MB 3P D25	D	25	10	3	4	0.345
P1 MB 3P D32	D	32	10	3	4	0.345
P1 MB 3P D40	D	40	10	3	4	0.345
P1 MB 3P D50	D	50	10	3	4	0.345
P1 MB 3P D63	D	63	10	3	4	0.345

General characteristics

These devices are used to protect against short circuits and overloads of wiring installations and loads in panel boards, office buildings, stores and similar applications. Their purpose is circuit protection, circuit isolation and load operation controls. They have characteristics of instantaneous trip defined as follows:

- B-curve: instantaneous trip 3...5 times In for non-inductive or low inductive loads (heating resistors, generators, very long wire lines)
- C-curve: instantaneous trip 5...10 times In for inductive loads (mixed loads, resistive and inductive with low inrush current)
- D-curve: instantaneous trip 10...14 times In for highly inductive loads (loads with high inrush and current such as motors).

Main features include:

- IEC rated current In: 1...63A
- Pole width: 17.5mm / 0.69"
- Contact status with flag indicator
- Trip characteristic: Curve type B, C and D
- Auxiliary contacts and trip releases mounted on left side
- Fixing on 35mm DIN rail (IEC/EN 60715).

Operational characteristics

- Dissipation per pole: 3...13W
- IEC rated insulation voltage Ui: 440V
- IEC rated impulse voltage Uimp: 4kV
- IEC rated operational voltage Ue: 230/400VAC.

Certifications and compliance

Certifications obtained: TÜV – Rheinland; UL Recognized for USA and Canada (cURus – File E359585) as "Supplementary Protectors", designated as Overcurrent type, for general industrial use, suitable for factory wiring only with 125-135% tripping current of amp rating. Products having this type of marking are intended for use as components of complete workshop- assembled equipment.

Compliant with standards: IEC/EN 60898-1, IEC/EN 60947-2, UL 1077, CSA C22.2 n°235.

4P - 10kA 4 modules



P1 MB 4P...

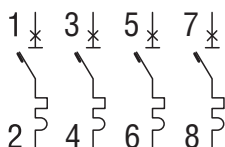

Order code	Curve	IEC In	IEC Icn	N° of DIN module	Qty per pkg	Wt
	Type	[A]	[kA]	n°	n°	[kg]

Four pole, thermal and magnetic trip type, B-curve characteristic.

P1 MB 4P B01	B	1	10	4	3	0.460
P1 MB 4P B02	B	2	10	4	3	0.460
P1 MB 4P B04	B	4	10	4	3	0.460
P1 MB 4P B06	B	6	10	4	3	0.460
P1 MB 4P B10	B	10	10	4	3	0.460
P1 MB 4P B13	B	13	10	4	3	0.460
P1 MB 4P B16	B	16	10	4	3	0.460
P1 MB 4P B20	B	20	10	4	3	0.460
P1 MB 4P B25	B	25	10	4	3	0.460
P1 MB 4P B32	B	32	10	4	3	0.460
P1 MB 4P B40	B	40	10	4	3	0.460
P1 MB 4P B50	B	50	10	4	3	0.460
P1 MB 4P B63	B	63	10	4	3	0.460

Four pole, thermal and magnetic trip type, C-curve characteristic.

P1 MB 4P C01	C	1	10	4	3	0.460
P1 MB 4P C02	C	2	10	4	3	0.460
P1 MB 4P C04	C	4	10	4	3	0.460
P1 MB 4P C06	C	6	10	4	3	0.460
P1 MB 4P C10	C	10	10	4	3	0.460
P1 MB 4P C13	C	13	10	4	3	0.460
P1 MB 4P C16	C	16	10	4	3	0.460
P1 MB 4P C20	C	20	10	4	3	0.460
P1 MB 4P C25	C	25	10	4	3	0.460
P1 MB 4P C32	C	32	10	4	3	0.460
P1 MB 4P C40	C	40	10	4	3	0.460
P1 MB 4P C50	C	50	10	4	3	0.460
P1 MB 4P C63	C	63	10	4	3	0.460

Four pole, thermal and magnetic trip type, D-curve characteristic.

P1 MB 4P D01	D	1	10	4	3	0.460
P1 MB 4P D02	D	2	10	4	3	0.460
P1 MB 4P D04	D	4	10	4	3	0.460
P1 MB 4P D06	D	6	10	4	3	0.460
P1 MB 4P D10	D	10	10	4	3	0.460
P1 MB 4P D13	D	13	10	4	3	0.460
P1 MB 4P D16	D	16	10	4	3	0.460
P1 MB 4P D20	D	20	10	4	3	0.460
P1 MB 4P D25	D	25	10	4	3	0.460
P1 MB 4P D32	D	32	10	4	3	0.460
P1 MB 4P D40	D	40	10	4	3	0.460
P1 MB 4P D50	D	50	10	4	3	0.460
P1 MB 4P D63	D	63	10	4	3	0.460

General characteristics

These devices are used to protect against short circuits and overloads of wiring installations and loads in panel boards, office buildings, stores and similar applications. Their purpose is circuit protection, circuit isolation and load operation controls. They have characteristics of instantaneous trip defined as follows:

- B-curve: instantaneous trip 3...5 times I_n for non-inductive or low inductive loads (heating resistors, generators, very long wire lines)
- C-curve: instantaneous trip 5...10 times I_n for inductive loads (mixed loads, resistive and inductive with low inrush current)
- D-curve: instantaneous trip 10...14 times I_n for highly inductive loads (loads with high inrush and current such as motors).

Main features include:

- IEC rated current I_n : 1...63A
- Pole width: 17.5mm / 0.69"
- Contact status with flag indicator
- Trip characteristic: Curve type B, C and D
- Auxiliary contacts and trip releases mounted on left side
- Fixing on 35mm DIN rail (IEC/EN 60715).

Operational characteristics

- Dissipation per pole: 3...13W
- IEC rated insulation voltage U_i : 440V
- IEC rated impulse voltage U_{imp} : 4kV
- IEC rated operational voltage U_e : 230/400VAC.

Certifications and compliance

Certifications obtained: TÜV – Rheinland; UL Recognized for USA and Canada (cURus – File E359585) as "Supplementary Protectors", designated as Overcurrent type, for general industrial use, suitable for factory wiring only with 125-135% tripping current of amp rating. Products having this type of marking are intended for use as components of complete workshop- assembled equipment.

Compliant with standards: IEC/EN 60898-1, IEC/EN 60947-2, UL 1077, CSA C22.2 n°235.

1P - 10kA 1 module



P1 MB... 1P...



new

Order code	Curve	IEC In	Rat. volt.	N° of DIN mod.	Qty per pkg	Wt
	Type	[A]	[V]	n°	n°	[kg]

One pole, thermal and magnetic trip type, C-curve characteristic.

P1 MB UH 1P C01	C	1	277	1	12	0.133
P1 MB UH 1P C01V6	C	1.6	277	1	12	0.133
P1 MB UH 1P C02	C	2	277	1	12	0.133
P1 MB UH 1P C03	C	3	277	1	12	0.133
P1 MB UH 1P C04	C	4	277	1	12	0.133
P1 MB UH 1P C05	C	5	277	1	12	0.133
P1 MB UH 1P C06	C	6	277	1	12	0.133
P1 MB UH 1P C07	C	7	277	1	12	0.133
P1 MB UH 1P C08	C	8	277	1	12	0.133
P1 MB UH 1P C10	C	10	277	1	12	0.133
P1 MB UH 1P C12	C	12	277	1	12	0.133
P1 MB UH 1P C13	C	13	277	1	12	0.133
P1 MB UH 1P C15	C	15	277	1	12	0.133
P1 MB UH 1P C16	C	16	277	1	12	0.133
P1 MB UH 1P C20	C	20	277	1	12	0.133
P1 MB UH 1P C25	C	25	277	1	12	0.133
P1 MB UH 1P C30	C	30	277	1	12	0.133
P1 MB UH 1P C32	C	32	277	1	12	0.133
P1 MB UL 1P C35	C	35	120	1	12	0.133
P1 MB UL 1P C40	C	40	120	1	12	0.133
P1 MB UL 1P C50	C	50	120	1	12	0.133
P1 MB UL 1P C60	C	60	120	1	12	0.133
P1 MB UL 1P C63	C	63	120	1	12	0.133

One pole, thermal and magnetic trip type, D-curve characteristic.

P1 MB UH 1P D01	D	1	277	1	12	0.133
P1 MB UH 1P D01V6	D	1.6	277	1	12	0.133
P1 MB UH 1P D02	D	2	277	1	12	0.133
P1 MB UH 1P D03	D	3	277	1	12	0.133
P1 MB UH 1P D04	D	4	277	1	12	0.133
P1 MB UH 1P D05	D	5	277	1	12	0.133
P1 MB UH 1P D06	D	6	277	1	12	0.133
P1 MB UH 1P D07	D	7	277	1	12	0.133
P1 MB UH 1P D08	D	8	277	1	12	0.133
P1 MB UH 1P D10	D	10	277	1	12	0.133
P1 MB UH 1P D12	D	12	277	1	12	0.133
P1 MB UH 1P D13	D	13	277	1	12	0.133
P1 MB UH 1P D15	D	15	277	1	12	0.133
P1 MB UH 1P D16	D	16	277	1	12	0.133
P1 MB UH 1P D20	D	20	277	1	12	0.133
P1 MB UH 1P D25	D	25	277	1	12	0.133
P1 MB UH 1P D30	D	30	277	1	12	0.133
P1 MB UH 1P D32	D	32	277	1	12	0.133
P1 MB UL 1P D35	D	35	120	1	12	0.133
P1 MB UL 1P D40	D	40	120	1	12	0.133
P1 MB UL 1P D50	D	50	120	1	12	0.133
P1 MB UL 1P D60	D	60	120	1	12	0.133
P1 MB UL 1P D63	D	63	120	1	12	0.133

new

General characteristics

These devices comply with the UL 489 standard, mostly used in the North American markets, are designed to protect feeder circuits, the part of the system from the network supply point to the protection device for a branch circuit. They can in any case be used on the international market thanks to compliance with the IEC/EN60947-2 standard as well.

They have characteristics of tripping instantaneously defined as follows:

- C-curve: instantaneous trip 5...10 times I_n for inductive loads (mixed loads, resistive and inductive with low inrush current)
- D-curve: instantaneous trip 10...14 times I_n for highly inductive loads (loads with high inrush and current such as motors).

Operational characteristics

- Dissipation per pole: 3...13W
- Rated voltage 1...32A: 277V (UL489)
- Rated voltage 35...63A: 120V (UL489)
- Rated insulation voltage U_i : 440V (IEC/EN60947-2)
- Rated impulse voltage U_{imp} : 4kV (IEC/EN60947-2)
- Rated operational voltage U_e : 230/400VAC (IEC/EN60947-2)
- DC operational voltage: 60V

Certifications and compliance

Certifications obtained: cULus.

Compliant with standards: UL 489, IEC/EN 60947-2.

2P - 10kA 2 modules



P1 MB... 2P...

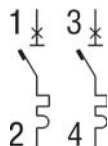

Order code	Curve	IEC In	Rated voltage	N° of DIN mod.	Qty per pkg	Wt
	Type	[A]	[V]	n°	n°	[kg]

Two pole, thermal and magnetic trip type, C-curve characteristic.

P1 MB UH 2P C01	C	1	480Y/277	2	6	0.255
P1 MB UH 2P C01V6	C	1.6	480Y/277	2	6	0.255
P1 MB UH 2P C02	C	2	480Y/277	2	6	0.255
P1 MB UH 2P C03	C	3	480Y/277	2	6	0.255
P1 MB UH 2P C04	C	4	480Y/277	2	6	0.255
P1 MB UH 2P C05	C	5	480Y/277	2	6	0.255
P1 MB UH 2P C06	C	6	480Y/277	2	6	0.255
P1 MB UH 2P C07	C	7	480Y/277	2	6	0.255
P1 MB UH 2P C08	C	8	480Y/277	2	6	0.255
P1 MB UH 2P C10	C	10	480Y/277	2	6	0.255
P1 MB UH 2P C12	C	12	480Y/277	2	6	0.255
P1 MB UH 2P C13	C	13	480Y/277	2	6	0.255
P1 MB UH 2P C15	C	15	480Y/277	2	6	0.255
P1 MB UH 2P C16	C	16	480Y/277	2	6	0.255
P1 MB UH 2P C20	C	20	480Y/277	2	6	0.255
P1 MB UH 2P C25	C	25	480Y/277	2	6	0.255
P1 MB UH 2P C30	C	30	480Y/277	2	6	0.255
P1 MB UH 2P C32	C	32	480Y/277	2	6	0.255
P1 MB UL 2P C35	C	35	240	2	6	0.255
P1 MB UL 2P C40	C	40	240	2	6	0.255
P1 MB UL 2P C50	C	50	240	2	6	0.255
P1 MB UL 2P C60	C	60	240	2	6	0.255
P1 MB UL 2P C63	C	63	240	2	6	0.255

Two pole, thermal and magnetic trip type, D-curve characteristic.

P1 MB UH 2P D01	D	1	480Y/277	2	6	0.255
P1 MB UH 2P D01V6	D	1.6	480Y/277	2	6	0.255
P1 MB UH 2P D02	D	2	480Y/277	2	6	0.255
P1 MB UH 2P D03	D	3	480Y/277	2	6	0.255
P1 MB UH 2P D04	D	4	480Y/277	2	6	0.255
P1 MB UH 2P D05	D	5	480Y/277	2	6	0.255
P1 MB UH 2P D06	D	6	480Y/277	2	6	0.255
P1 MB UH 2P D07	D	7	480Y/277	2	6	0.255
P1 MB UH 2P D08	D	8	480Y/277	2	6	0.255
P1 MB UH 2P D10	D	10	480Y/277	2	6	0.255
P1 MB UH 2P D12	D	12	480Y/277	2	6	0.255
P1 MB UH 2P D13	D	13	480Y/277	2	6	0.255
P1 MB UH 2P D15	D	15	480Y/277	2	6	0.255
P1 MB UH 2P D16	D	16	480Y/277	2	6	0.255
P1 MB UH 2P D20	D	20	480Y/277	2	6	0.255
P1 MB UH 2P D25	D	25	480Y/277	2	6	0.255
P1 MB UH 2P D30	D	30	480Y/277	2	6	0.255
P1 MB UH 2P D32	D	32	480Y/277	2	6	0.255
P1 MB UL 2P D35	D	35	240	2	6	0.255
P1 MB UL 2P D40	D	40	240	2	6	0.255
P1 MB UL 2P D50	D	50	240	2	6	0.255
P1 MB UL 2P D60	D	60	240	2	6	0.255
P1 MB UL 2P D63	D	63	240	2	6	0.255

General characteristics

These devices comply with the UL 489 standard, mostly used in the North American markets, are designed to protect feeder circuits, the part of the system from the network supply point to the protection device for a branch circuit. They can in any case be used on the international market thanks to compliance with the IEC/EN60947-2 standard as well.

They have characteristics of tripping instantaneously defined as follows:

- C-curve: instantaneous trip 5...10 times I_n for inductive loads (mixed loads, resistive and inductive with low inrush current)
- D-curve: instantaneous trip 10...14 times I_n for highly inductive loads (loads with high inrush and current such as motors).

Operational characteristics

- Rated voltage 1...32A: 480Y/277V (UL489)
- Rated voltage 40...63A: 240V (UL489)
- Rated insulation voltage U_i : 440V (IEC/EN60947-2)
- Rated impulse voltage U_{imp} : 4kV (IEC/EN60947-2)
- Rated operational voltage U_e : 230/400VAC (IEC/EN60947-2)
- DC operational voltage: 125V

Certifications and compliance

Certifications obtained: cULus.
Compliant with standards: UL 489, IEC/EN 60947-2.

3P - 10kA 3 modules



P1 MB... 3P...

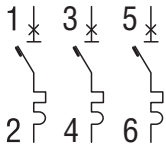

Order code	Curve	IEC In	Rated voltage	N° of DIN mod.	Qty per pkg	Wt
	Type	[A]	[V]	n°	n°	[kg]

Three pole, thermal and magnetic trip type, C-curve characteristic.

P1 MB UH 3P C01	C	1	480V/277	3	4	0.388
P1 MB UH 3P C01V6	C	1.6	480V/277	3	4	0.388
P1 MB UH 3P C02	C	2	480V/277	3	4	0.388
P1 MB UH 3P C03	C	3	480V/277	3	4	0.388
P1 MB UH 3P C04	C	4	480V/277	3	4	0.388
P1 MB UH 3P C05	C	5	480V/277	3	4	0.388
P1 MB UH 3P C06	C	6	480V/277	3	4	0.388
P1 MB UH 3P C07	C	7	480V/277	3	4	0.388
P1 MB UH 3P C08	C	8	480V/277	3	4	0.388
P1 MB UH 3P C10	C	10	480V/277	3	4	0.388
P1 MB UH 3P C12	C	12	480V/277	3	4	0.388
P1 MB UH 3P C13	C	13	480V/277	3	4	0.388
P1 MB UH 3P C15	C	15	480V/277	3	4	0.388
P1 MB UH 3P C16	C	16	480V/277	3	4	0.388
P1 MB UH 3P C20	C	20	480V/277	3	4	0.388
P1 MB UH 3P C25	C	25	480V/277	3	4	0.388
P1 MB UH 3P C30	C	30	480V/277	3	4	0.388
P1 MB UH 3P C32	C	32	480V/277	3	4	0.388
P1 MB UL 3P C35	C	35	240	3	4	0.388
P1 MB UL 3P C40	C	40	240	3	4	0.388
P1 MB UL 3P C50	C	50	240	3	4	0.388
P1 MB UL 3P C60	C	60	240	3	4	0.388
P1 MB UL 3P C63	C	63	240	3	4	0.388

Three pole, thermal and magnetic trip type, D-curve characteristic.

P1 MB UH 3P D01	D	1	480V/277	3	4	0.388
P1 MB UH 3P D01V6	D	1,6	480V/277	3	4	0.388
P1 MB UH 3P D02	D	2	480V/277	3	4	0.388
P1 MB UH 3P D03	D	3	480V/277	3	4	0.388
P1 MB UH 3P D04	D	4	480V/277	3	4	0.388
P1 MB UH 3P D05	D	5	480V/277	3	4	0.388
P1 MB UH 3P D06	D	6	480V/277	3	4	0.388
P1 MB UH 3P D07	D	7	480V/277	3	4	0.388
P1 MB UH 3P D08	D	8	480V/277	3	4	0.388
P1 MB UH 3P D10	D	10	480V/277	3	4	0.388
P1 MB UH 3P D12	D	12	480V/277	3	4	0.388
P1 MB UH 3P D13	D	13	480V/277	3	4	0.388
P1 MB UH 3P D15	D	15	480V/277	3	4	0.388
P1 MB UH 3P D16	D	16	480V/277	3	4	0.388
P1 MB UH 3P D20	D	20	480V/277	3	4	0.388
P1 MB UH 3P D25	D	25	480V/277	3	4	0.388
P1 MB UH 3P D30	D	30	480V/277	3	4	0.388
P1 MB UH 3P D32	D	32	480V/277	3	4	0.388
P1 MB UL 3P D35	D	35	240	3	4	0.388
P1 MB UL 3P D40	D	40	240	3	4	0.388
P1 MB UL 3P D50	D	50	240	3	4	0.388
P1 MB UL 3P D60	D	60	240	3	4	0.388
P1 MB UL 3P D63	D	63	240	3	4	0.388

General characteristics

These devices comply with the UL 489 standard, mostly used in the North American markets, are designed to protect feeder circuits, the part of the system from the network supply point to the protection device for a branch circuit. They can in any case be used on the international market thanks to compliance with the IEC/EN60947-2 standard as well.

They have characteristics of tripping instantaneously defined as follows:

- C-curve: instantaneous trip 5...10 times I_n for inductive loads (mixed loads, resistive and inductive with low inrush current)
- D-curve: instantaneous trip 10...14 times I_n for highly inductive loads (loads with high inrush and current such as motors).

Operational characteristics

- Rated voltage 1...32A: 480V/277V (UL 489)
- Rated voltage 40...63A: 240V (UL 489)
- Rated insulation voltage U_i : 440V (IEC/EN60947-2)
- Rated impulse voltage U_{imp} : 4kV (IEC/EN60947-2)
- Rated operational voltage U_e : 230/400VAC (IEC/EN60947-2)
- DC operational voltage: 125V

Certifications and compliance

Certifications obtained: cULus.

Compliant with standards: UL 489, IEC/EN 60947-2.

1P, 2P, 3P and 4P - 10kA



P2 MB 1P...



P2 MB 2P...

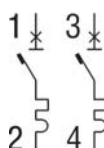

P2 MB 3P...

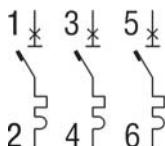

P2 MB 4P...

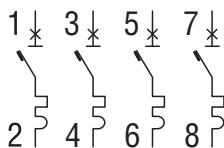

Order code	Curve	IEC In	IEC Icn	N° of DIN module	Qty per pkg	Wt
	Type	[A]	[kA]	no.	no.	[kg]

One pole, thermal and magnetic trip type, C-curve characteristic.

P2 MB 1P C080	C	80	10 [ⓘ]	1.5	9	0.166
P2 MB 1P C100	C	100	10 [ⓘ]	1.5	9	0.166
P2 MB 1P C125	C	125	10 [ⓘ]	1.5	9	0.166

Two pole, thermal and magnetic trip type, C-curve characteristic.

P2 MB 2P C080	C	80	10	3	4	0.340
P2 MB 2P C100	C	100	10	3	4	0.340
P2 MB 2P C125	C	125	10	3	4	0.340

Three pole, thermal and magnetic trip type, C-curve characteristic.

P2 MB 3P C080	C	80	10	4.5	3	0.510
P2 MB 3P C100	C	100	10	4.5	3	0.510
P2 MB 3P C125	C	125	10	4.5	3	0.510

Four pole, thermal and magnetic trip type, C-curve characteristic.

P2 MB 4P C080	C	80	10	6	2	0.680
P2 MB 4P C100	C	100	10	6	2	0.680
P2 MB 4P C125	C	125	10	6	2	0.680

Three pole, thermal and magnetic trip type, D-curve characteristic.

P2 MB 3P D080	D	80	10	4.5	3	0.510
P2 MB 3P D100	D	100	10	4.5	3	0.510
P2 MB 3P D125	D	125	10	4.5	3	0.510

Four pole, thermal and magnetic trip type, D-curve characteristic.

P2 MB 4P D080	D	80	10	6	2	0.510
P2 MB 4P D100	D	100	10	6	2	0.510
P2 MB 4P D125	D	125	10	6	2	0.510

[ⓘ] Icn at 230V.

General characteristics

These devices are used to protect against short circuits and overloads of wiring installations and loads in panel boards, office buildings, stores and similar applications. Their purpose is circuit protection, circuit isolation and load operation controls. They have characteristics of instantaneous trip defined as follows:

- C-curve: instantaneous trip 5...10 times In for inductive loads (mixed loads, resistive and inductive with low inrush current)
- D-curve: instantaneous trip 10...14 times In for highly inductive loads (loads with high inrush and current such as motors).

Main features include:

- IEC rated current In: 80...125A
- Pole width: 27mm / 1.06"
- Contact status with flag indicator
- Trip characteristic: Curve type C and D
- Fixing on 35mm DIN rail (IEC/EN 60715).

Operational characteristics

- Dissipation per pole: 15...20W
- IEC rated insulation voltage Ui: 400V
- IEC rated impulse voltage Uimp: 6kV
- IEC rated operational voltage Ue: 230/400VAC.

Certifications and compliance

Certifications obtained: TÜV – Rheinland; UL Recognized for USA and Canada (cURus – File E359585) as "Supplementary Protectors", designated as Overcurrent type, for general industrial use, suitable for factory wiring only with more than 135% tripping current of amp rating. Products having this type of marking are intended for use as components of complete workshop- assembled equipment.

Compliant with standards: IEC/EN 60898-1, IEC/EN 60947-2, UL 1077, CSA C22.2 n°235.

Add-on blocks for miniature circuit breakers 1...63A



P1X 1011

P1X 16230

new

Order code	Description	Qty per MCB	Qty per pkg	Wt
		n°	n°	[kg]
Auxiliary contact.				
P1X 1011	1 changeover contact	1	10	0.040
P1X 1011UH	1 changeover contact for P1 MB U	1	10	0.040
Indicator contact for thermal-magnetic trip.				
P1X 1311	1 changeover contact	1	10	0.040
Undervoltage trip release.				
P1X 14230	230V 50/60Hz	1	8	0.070
Shunt trip release.				
P1X 16230	110...415V 50/60Hz	1	8	0.070

❶ Not suitable for P1 MB U...

General characteristics

- Auxiliary and indicator contact width: 9mm/0.35" (0.5 module)
- Undervoltage and shunt trip release width: 18mm/0.71" (1 module)
- Maximum combination: 3 add-on blocks on MCB left side only of which 1 undervoltage or shunt release directly on MCB side and then 2 contacts of which 1 auxiliary and 1 indicator.

Operational characteristics

- IEC rated impulse voltage Uimp: 4kV
- IEC rated operational current in AC: 6A 230V; 3A 400V (auxiliary contacts).

Certifications and compliance

Certifications obtained: cURus (excluding P1X 14230), UL (only P1X 14230)
Compliant with standards: IEC/EN 60947-5-1, CSA C22.2 n° 5.

Add-on blocks for miniature circuit breakers 80...125A



P2X 1311

P2X 16230

new

Order code	Description	Qty per MCB	Qty per pkg	Wt
		n°	n°	[kg]
Auxiliary contact.				
P2X 1011	1 changeover contact	1	10	0.040
Indicator contact for thermal-magnetic trip.				
P2X 1311	1 changeover contact	1	10	0.040
Shunt trip release.				
P2X 16230	110...415V 50/60Hz	1	8	0.070

General characteristics

- Auxiliary and indicator contact width: 9mm/0.35" (0.5 module)
- Shunt trip release width: 17.5mm/0.69" (1 module)
- Maximum combination: 3 add-on blocks on MCB sides of which 1 undervoltage or shunt release on MCB right side and 2 contacts on the left of which 1 auxiliary and 1 indicator.

Operational characteristics

- Rated impulse voltage Uimp: 4kV
- Rated operational current in AC: 6A 230V; 3A 400V (auxiliary contacts).

Compliance

Compliant with standards: IEC/EN 60947-5-1.

Accessories for miniature circuit breakers



P1X 90 33



P1X 91 33



P1X 92 01



P1X 92 10

new

new

new



P1X 18 10



P2X 18 10

❶ Suitable for P1 MB...
Not suitable for P1 MB U...

Order code	Description	Qty per pkg	Wt
		n°	[kg]
P1X 90 31	Single-pole supply busbar	10	0.160
P1X 90 32	Two-pole supply busbar	10	0.320
P1X 90 33	Three-pole supply busbar	10	0.474
P1X 90 34	Four-pole supply busbar	10	0.600
P1X 91 30	Kit of 5 isolating covers for unused busbar terminals	10	0.030
P1X 91 31	End cap for P1X9031	50	0.001
P1X 91 32	End cap for P1X9032	50	0.001
P1X 91 33	End cap for P1X9033	50	0.001
P1X 91 34	End cap for P1X9034	50	0.001
P1X 92 01	Single-pole terminal for busbar supply; conductor cross section 25mm ² max.	25	0.010
P1X 92 10	1-pole terminal for supplying busbar; conductor cross section 25mm ² max.; left entry	25	0.010
P1X 92 02	Single-pole terminal for busbar supply; conductor cross section 50mm ² max.	25	0.022
P1X 18 10	Padlockable attachment for breaker control lever P1MB...	10	0.001
P2X 18 10	Padlockable attachment for breaker control lever P2MB...	10	0.002

General and operational characteristics

SINGLE-POLE SUPPLY BUSBAR

- Rated operational voltage Ue: 1000V
- Central point of power supply: 100A max.
- Side point of power supply: 63A max.
- Spacing: 17.5mm/0.69"
- Busbar section: 10mm²
- For paralleling connection
- For 57 modules, 1000mm/39.37" long (57 1P breakers).

TWO-POLE, THREE-POLE AND FOUR-POLE SUPPLY BUSBARS

- Rated operational voltage Ue: 690V
- Central point of power supply: 100A max.
- Side point of power supply: 63A max.
- Pitch: 18mm/0.71"
- Busbar section: 10mm²
- For paralleling connection
- Two-pole: for 56 modules, 1000mm/39.37" long (28 2P breakers)
- Three-pole: for 57 modules, 1012mm/39.84" long (19 3P breakers)
- Four-pole: for 56 modules, 1000mm/39.37" long (14 4P breakers).

PADLOCKABLE ATTACHMENT

- Max. padlock diameter 5mm/0.20"
- Padlockable in ON and OFF
- One can be fitted for each pole of the breaker.

Modular socket



P1X7

new

Order code	Description	Qty per pkg	Wt
		n°	[kg]
P1X7	Modular socket for Italy and Germany (Schuko); 16A.	5	0.123

General and operational characteristics

- Max. current: 16A
- Connectable section 1.5...10mm²
- Tightening torque: 1.8Nm
- Fixing on 35mm DIN rail (IEC/EN 60715)
- DIN modules: 2.5.

Compliance

Compliant with standards: IEC 60884-1.

Residual blocks



P1 RA 2P...

new



P1 RA 3P...

Order code	Type	IEC In	IEC IΔn	N° of DIN module	Qty per pkg	Wt
		[A]	[mA]	n°	n°	[kg]

Residual blocks – 2P – type A.

P1 RA 2P 40 A030	A	40	30	2	1	0.160
P1 RA 2P 40 A300	A	40	300	2	1	0.160
P1 RA 2P 63 A030	A	63	30	2	1	0.160
P1 RA 2P 63 A300	A	63	300	2	1	0.160

Residual blocks – 3P – type A.

P1 RA 3P 40 A030	A	40	30	3.5	1	0.205
P1 RA 3P 40 A300	A	40	300	3.5	1	0.205
P1 RA 3P 63 A030	A	63	30	3.5	1	0.205
P1 RA 3P 63 A300	A	63	300	3.5	1	0.205

Residual blocks – 4P – type A.

P1 RA 4P 40 A030	A	40	30	3.5	1	0.230
P1 RA 4P 40 A300	A	40	300	3.5	1	0.230
P1 RA 4P 63 A030	A	63	30	3.5	1	0.230
P1 RA 4P 63 A300	A	63	300	3.5	1	0.230

General characteristics

These devices are intended for the protection of people against indirect contact (electric shock) and of installations against fire hazards due to a persistent earth/ground fault current.

They snap onto the P1MB series thermal-magnetic circuit breakers; this combination forms a single device to protect people, protect against fire and protect lines.

Operational characteristics

- IEC rated insulation voltage U_i : 400V
- IEC rated impulse voltage U_{imp} : 4kV
- IEC rated frequency: 50/60Hz
- IEC rated operational voltage U_e : 230/400V
- IEC rated residual current for tripping $I_{\Delta n}$: 30mA; 300mA.

Certifications and compliance

Compliance with standards: IEC/EN 61009-1.

Residual current operated circuit breakers



P1 RC 2P...



P1 RC 4P...



P1 RC 4P B...

new

new

Order code	Type	IEC In	IEC IΔn	N° of DIN module	Qty per pkg	Wt
		[A]	[mA]	n°	n°	[kg]

Two pole RCCB type AC.

P1 RC 2P 25 AC030	AC	25	30	2	6	0.185
P1 RC 2P 25 AC300	AC	25	300	2	6	0.185
P1 RC 2P 40 AC030	AC	40	30	2	6	0.185
P1 RC 2P 40 AC300	AC	40	300	2	6	0.185
P1 RC 2P 63 AC030	AC	63	30	2	6	0.185
P1 RC 2P 63 AC300	AC	63	300	2	6	0.185

Two pole RCCB type A.

P1 RC 2P 25 A030	A	25	30	2	6	0.185
P1 RC 2P 25 A300	A	25	300	2	6	0.185
P1 RC 2P 40 A030	A	40	30	2	6	0.185
P1 RC 2P 40 A300	A	40	300	2	6	0.185
P1 RC 2P 63 A030	A	63	30	2	6	0.185
P1 RC 2P 63 A300	A	63	300	2	6	0.185

Four pole RCCB type AC.

P1 RC 4P 25 AC030	AC	25	30	4	3	0.326
P1 RC 4P 25 AC300	AC	25	300	4	3	0.326
P1 RC 4P 40 AC030	AC	40	30	4	3	0.326
P1 RC 4P 40 AC300	AC	40	300	4	3	0.326
P1 RC 4P 63 AC030	AC	63	30	4	3	0.326
P1 RC 4P 63 AC300	AC	63	300	4	3	0.326

Four pole RCCB type A.

P1 RC 4P 25 A030	A	25	30	4	3	0.326
P1 RC 4P 25 A300	A	25	300	4	3	0.326
P1 RC 4P 40 A030	A	40	30	4	3	0.326
P1 RC 4P 40 A300	A	40	300	4	3	0.326
P1 RC 4P 63 A030	A	63	30	4	3	0.326
P1 RC 4P 63 A300	A	63	300	4	3	0.326

Two pole RCCB type B.

P1 RC 2P 40 B030	B	40	30	4	3	0.280
P1 RC 2P 40 B300	B	40	300	4	3	0.280
P1 RC 2P 63 B030	B	63	30	4	3	0.280
P1 RC 2P 63 B300	B	63	300	4	3	0.280

Four pole RCCB type B.

P1 RC 4P 40 B030	B	40	30	4	3	0.335
P1 RC 4P 40 B300	B	40	300	4	3	0.335
P1 RC 4P 63 B030	B	63	30	4	3	0.335
P1 RC 4P 63 B300	B	63	300	4	3	0.335
P1 RC 4P 80 B030	B	80	30	4	3	0.335
P1 RC 4P 80 B300	B	80	300	4	3	0.335

General characteristics

These RCCBs are intended for the protection of people against indirect contact (electric shock) and of installations against fire hazards due to a persistent earth/ground fault current. Specifically to prevent electric shock, RCCBs must be rated with a rated residual current ($I_{\Delta n}$) not exceeding 30mA so that these devices trip in the case of earth/ground fault only. They usually are connected in series with thermal-magnetic breakers which assure short circuit and overcurrent protection too. P1RC types have a $I_{\Delta n}$ of either 30mA or 300mA and are available with three different versions of residual current tripping, as follows:

Type AC – Tripping for earth/ground fault is ensured “for residual sinusoidal alternating currents, suddenly applied or slowly rising”. It is identified by the symbol:

Type A – Tripping for earth/ground fault is ensured “for residual sinusoidal alternating currents and pulsating direct currents, suddenly applied or slowly rising”. In addition to the protection given by Type AC, this version protects against residual current with pulsating waveform. This can be caused by circuits connected with electronic equipment. The symbol identifying Type A is the following:

Type B – tripping is ensured for all conditions already covered by types AC and A. They also ensure tripping for high-frequency leakage currents up to 1000Hz and direct currents. They are particularly suitable for applications with inverters, UPSs and electric vehicle charging stations.

The symbol identifying Type B is the following:

Main features include:

- IEC rated current In: 25A, 40A and 63A
- Versions: 2P and 4P
- Type of operation: AC, A and B
- Pole width: 17.5mm / 0.69”
- Contact status with flag indicator
- Fixing on 35mm DIN rail (IEC/EN 60715).

Operational characteristics

- Dissipation per pole:
 - 1.1W for P1RC2/4 P25... type AC or A
 - 2.9W for P1RC2/4 P40... type AC, A or B
 - 7.2W for P1RC2/4P63... type AC, A or B
 - 9.7W for P1RC2/4P80... type B
- IEC rated insulation voltage U_i : 400V
- IEC rated impulse voltage U_{imp} : 4kV
- IEC rated frequency: 50/60Hz
- IEC rated operational voltage U_c : 230VAC for 2P; 230/400VAC for 4P
- IEC rated residual operating voltage U_e : $I_{\Delta n}$: 30mA; 300mA
- IEC short-circuit breaking capacity I_{cn} : 10kA

Certifications and compliance

Certifications obtained: TÜV SÜD (types AC and A); VDE (type B).
Compliant with standards: IEC/EN 61008-1 (all types); IEC/EN 62423 (type B).

1P+N - 10kA 2 modules



P1 RB 1N...

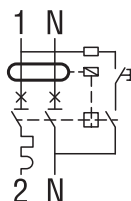

Order code	Curve	IEC In	IEC Icn	IEC IΔn	DIN n°	Qty per pkg	Wt [kg]
	Type	[A]	[kA]	[mA]	n°	n°	[kg]
Single pole + neutral RCBO type AC.							
P1 RB 1N C06 AC030	C	6	10	30	2	6	0.205
P1 RB 1N C06 AC300	C	6	10	300	2	6	0.205
P1 RB 1N C10 AC030	C	10	10	30	2	6	0.205
P1 RB 1N C10 AC300	C	10	10	300	2	6	0.205
P1 RB 1N C16 AC030	C	16	10	30	2	6	0.205
P1 RB 1N C16 AC300	C	16	10	300	2	6	0.205
P1 RB 1N C20 AC030	C	20	10	30	2	6	0.205
P1 RB 1N C20 AC300	C	20	10	300	2	6	0.205
P1 RB 1N C25 AC030	C	25	10	30	2	6	0.205
P1 RB 1N C25 AC300	C	25	10	300	2	6	0.205
P1 RB 1N C32 AC030	C	32	10	30	2	6	0.205
P1 RB 1N C32 AC300	C	32	10	300	2	6	0.205
P1 RB 1N C40 AC030	C	40	10	30	2	6	0.205
P1 RB 1N C40 AC300	C	40	10	300	2	6	0.205
Single pole + neutral RCBO type A.							
P1 RB 1N C06 A030	C	6	10	30	2	6	0.205
P1 RB 1N C06 A300	C	6	10	300	2	6	0.205
P1 RB 1N C10 A030	C	10	10	30	2	6	0.205
P1 RB 1N C10 A300	C	10	10	300	2	6	0.205
P1 RB 1N C13 A030	C	13	10	30	2	6	0.205
P1 RB 1N C16 A030	C	16	10	30	2	6	0.205
P1 RB 1N C16 A300	C	16	10	300	2	6	0.205
P1 RB 1N C20 A030	C	20	10	30	2	6	0.205
P1 RB 1N C20 A300	C	20	10	300	2	6	0.205
P1 RB 1N C25 A030	C	25	10	30	2	6	0.205
P1 RB 1N C25 A300	C	25	10	300	2	6	0.205
P1 RB 1N C32 A030	C	32	10	30	2	6	0.205
P1 RB 1N C32 A300	C	32	10	300	2	6	0.205
P1 RB 1N C40 A030	C	40	10	30	2	6	0.205
P1 RB 1N C40 A300	C	40	10	300	2	6	0.205

General characteristics

These devices both detect and trip in the event of residual current and protect circuits in the case of short circuits and overcurrent. From a practical point of view, they integrate both functions of MCB and of RCCB.

They have a C-type trip characteristic (instantaneous trip 5-10 times I_n) and are used for inductive loads (mixed loads, resistive and inductive with low inrush current). In addition, they have a rated residual current ($I_{\Delta n}$) of either 30mA or 300mA and are available with two different versions of residual current tripping type AC or A as described on page 13-12.

Its main features are:

- IEC rated current I_n : 6...40A
- Version: 1P+N
- Contact status with flag indicator
- Trip characteristic: Curve type C
- Fixing on 35mm DIN rail (IEC/EN 60715).

Operational characteristics

- Dissipation per pole: 3...13W
- Rated insulation voltage U_i : 400V
- Rated impulse voltage U_{imp} : 4kV
- Operating frequency: 50/60Hz
- Rated operational voltage U_e : 230VAC
- Rated residual operating voltage $I_{\Delta n}$: 30mA; 300mA
- IEC short-circuit breaking capacity I_{cn} : 10kA

Certifications and compliance

Certifications obtained: TÜV Rheinland.
Compliant with standards: IEC/EN 61009-1.

MINIATURE CIRCUIT BREAKERS

P1 MB...

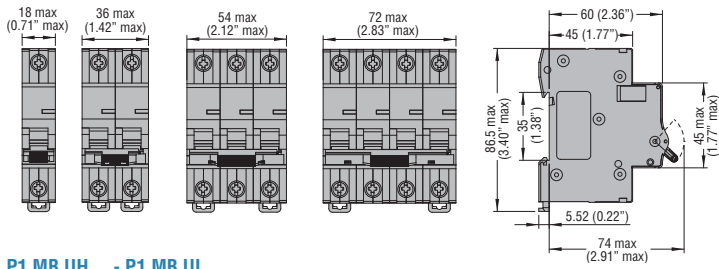

ACCESSORIES

Add-on contacts P1X 1011 - P1X 1011 UH - P1X 1311

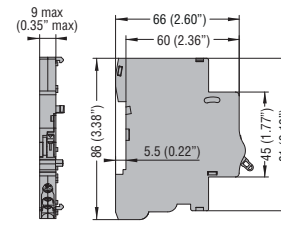

Undervoltage and shunt releases P1X 14230 - P1X 16230

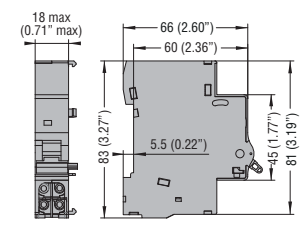

P1 MB UH... - P1 MB UL....

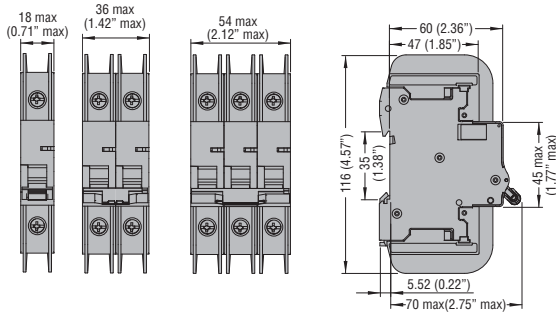

MINIATURE CIRCUIT BREAKERS

P2 MB...

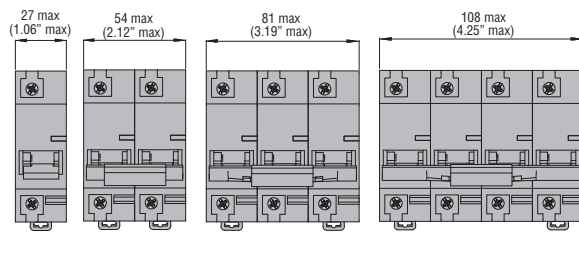

ACCESSORIES

Add-on contacts P2X 1011 - P2X 1311

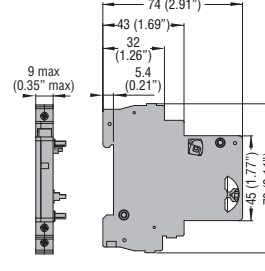

Shunt release P2X 16230

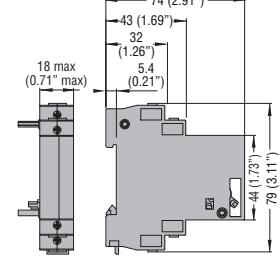

RESIDUAL BLOCKS

P1 RA

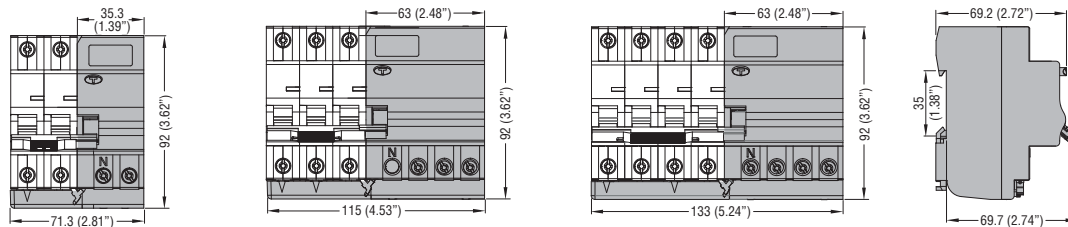

RESIDUAL CURRENT OPERATED CIRCUIT BREAKERS

P1 RC...

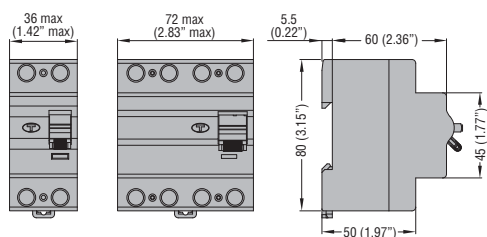

RESIDUAL CURRENT OPERATED CIRCUIT BREAKERS WITH OVERCURRENT PROTECTION

P1 RB...

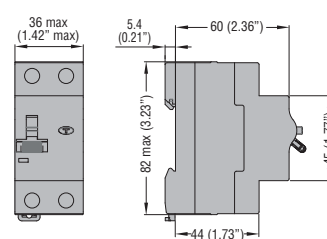

MODULAR SOCKET

P1X7

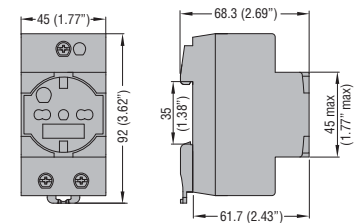

① 72mm for type-B residual current breakers.

Wiring diagrams

P1X 1011 - P1X 1011UH - P2X 1011

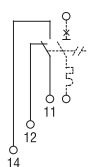

P1X 1311 - P2X 1311

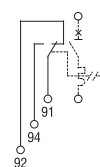

P1X 14230

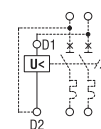

P1X 16230 - P2X 16230

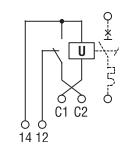

TYPE		P1 MB	P2 MB	P1 RA	P1 RC	P1 RB	
Description		Circuit breaker	Circuit breaker	Residual blocks	Residual current operated circuit breakers	Residual current operated circuit breakers w/ overcurrent prot.	
Standards		IEC/EN 60898, IEC/EN 60947-2 UL 1077 UL 489 ^①	IEC/EN 60947-2	IEC/EN 61008-1	IEC/EN 61008-1	IEC/EN 61009-1	
IEC rated insulation voltage U_i	V	440	400	400	400	400	
IEC rated impulse withstand voltage U_{imp}	kV	4	6	4	4	4	
IEC rated operational voltage U_e	in AC	230 (1P, 1P+N) / 230/400 (2P, 3P, 4P)	230 (1P) / 230/400 (2P, 3P, 4P)	230/400V	230 (2P) / 230/400(4P)	230	
	in DC	60 (1P) / 80 (2P)	60	—	—	—	
Rated frequency	Hz	50/60	50/60	50/60	50/60	50/60	
Maximum rated current	A	63	125	63	40	40	
Available rated current for types	A	1, 2, 4, 6, 10, 13, 16, 20, 25, 32, 40, 50, 63 ^②	80, 100, 125	40, 63	25, 40, 63 (80A only type B)	6, 10, 16, 20, 25, 32, 40	
Versions		1P, 1P+N, 2P, 3P, 4P	1P, 2P, 3P, 4P	2P, 3P, 4P	2P, 4P	1P+N	
Tripping characteristic	curve	B-C-D	C-D	—	—	C	
Instantaneous tripping		Curve B: 3...5I _n Curve C: 5...10I _n Curve D: 10...14I _n	Curve C: 5...10I _n Curve D: 10...14I _n	—	—	Curve C: 5...10I _n	
Residual operation characteristic	type	—	—	A	AC, A, B	AC, A	
Rated residual current $I_{\Delta n}$	mA	—	—	30, 300	30, 300	30, 300	
Short circuit capacity	kA	10 (6kA 1P+N)	10	—	10 (Inc)	10	
Mechanical life	cycle	20,000	10,000	20,000	20,000	20,000	
Maximum tightening torque of terminals	Nm	2	3	2	2	2	
	lbin	15	26	15	15	15	
	Tool	Pz2	Pz2	Pz2	Pz2	Pz2	
Conductor section min...max.	mm ²	1...16	2.5...50	1...16	2.5...35	1...25	
	AWG	14...6	14...1/0	14...6	14...2	16...3	
AMBIENT CONDITIONS							
Temperature	Operating	°C	-35...+70	-35...+75	-25...+55	-25...+55	-25...+40
	Storage	°C	-40...+80	-40...+80	-35...+60	-35...+60	-35...+60
Max. altitude	m	2,000	2,000	2,000	2,000	2,000	
Pollution degree		2	3	2	2	2	
Mounting		35mm DIN rail (IEC/EN 60715)					

TRIP CHARACTERISTICS

Curve B

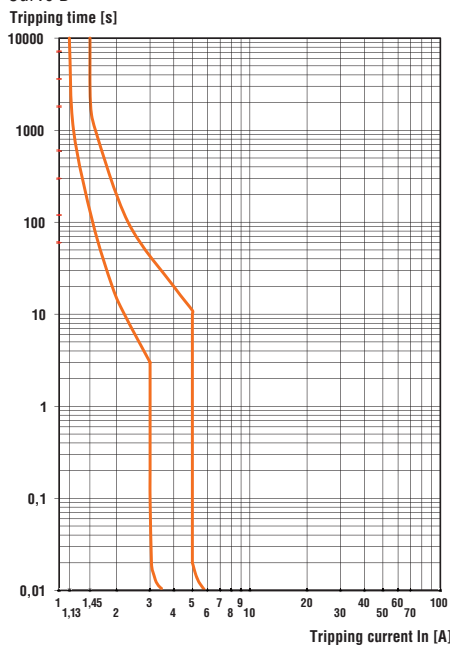

Curve C

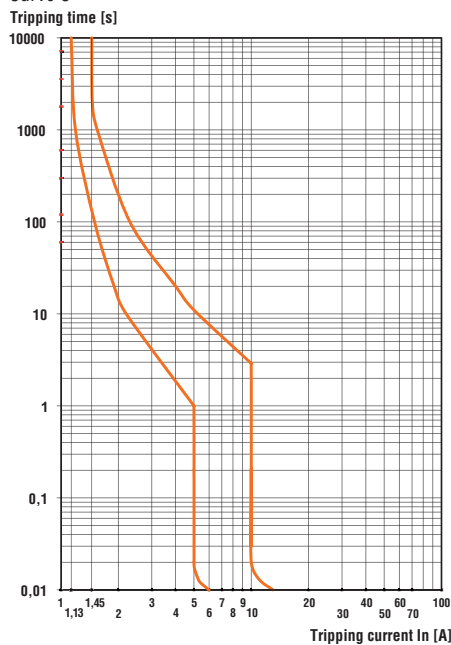

Curve D

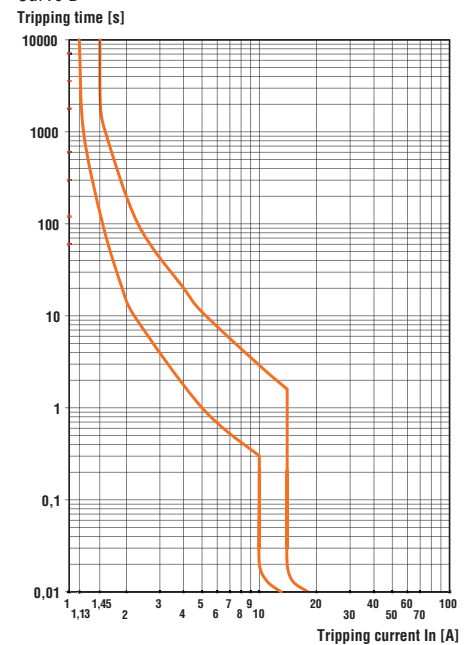

① UL489 only P1MBU... version for the operational voltages for these devices refer to the pages for the chosen product.

② For the UL489, P1MBU... versions, the following rated current currents are also available: 1.6, 3, 5, 7, 8, 12, 15, 30, 35, 60 A