

**Kemro**

**CP 240/B**

**CPU module**

**Project engineering manual V1.01**

**Translation of the original instructions**

**KEBA<sup>®</sup>**

Automation by innovation.

Document : V1.01 / article no.: 1004840  
Filename : cp240bpjen.chm  
Pages : 50

© KEBA 2013

Specifications are subject to change due to further technical developments. Details presented may be subject to correction.

All rights reserved.

**KEBA AG Headquarters:** Gewerbepark Urfahr, 4041 Linz, Austria, Phone: +43 732 7090-0, Fax: +43 732 7309-10,  
keba@keba.com

For information about our subsidiaries please look at [www.keba.com](http://www.keba.com).

## Record of Revision

Version	Date	Change in chapter	Description	changed by
1.00	12-2009	-	Newly created	rb
1.01	08-2011	Introduction	Hint "not for end customers" added, various minor updates, extended some chapters, to use the manual also standalone (especially: Displays and operating elements, Mounting and installation instructions and Diagnosis)	fstl, ekr



## Table of Contents

<b>1</b>	<b>Introduction.....</b>	<b>9</b>
1.1	Purpose of the document.....	9
1.2	Preconditions.....	9
1.3	Intended use.....	10
1.4	Notes on this document.....	10
	1.4.1 Contents of the document.....	10
	1.4.2 Not contained in this document.....	11
1.5	Documentation for further reading.....	11
1.6	EtherCAT declaration.....	11
<b>2</b>	<b>Safety notes.....</b>	<b>12</b>
2.1	Representation.....	12
2.2	General safety instructions.....	13
2.3	Safety instructions for personal safety.....	13
2.4	Safety instructions for device maintenance.....	14
<b>3</b>	<b>Description of the module.....</b>	<b>15</b>
3.1	Front view.....	15
3.2	Side view.....	16
3.3	Compact Flash slot.....	16
	3.3.1 Precautions when using the CF card.....	17
	3.3.2 Inserting the Compact Flash card.....	17
	3.3.3 Removing the Compact Flash card.....	17
3.4	Accessories.....	18
	3.4.1 Compact Flash card.....	18
	3.4.2 Connector strip.....	18
<b>4</b>	<b>Displays and operating elements.....</b>	<b>19</b>
4.1	Diagnostic display (DIAG).....	19
4.2	Status LEDs.....	19
4.3	Control key (CTRL) .....	19
4.4	CAN Status LEDs.....	20
4.5	Ethernet Gbit Status LEDs.....	20
4.6	SERCOS III status LEDs.....	21
<b>5</b>	<b>Mounting and installation instructions.....</b>	<b>22</b>
5.1	General instructions on assembly and removal.....	22
5.2	Inserting and removing of option modules.....	22
5.3	Adding modules.....	24
	5.3.1 Setting the module address.....	25
	5.3.2 Plugging modules together.....	26
5.4	Removing added modules.....	27
5.5	Mounting rail.....	27
5.6	Space requirement.....	28
5.7	Installing the module.....	28

5.7.1	End bracket.....	29
5.8	Removing the module.....	30
5.9	Air conditioning and ventilation.....	30
5.9.1	Use of air filters.....	30
<b>6</b>	<b>Connections and wiring.....</b>	<b>31</b>
6.1	Power supply.....	31
6.1.1	Connection example.....	32
6.2	Grounding.....	32
6.3	Graphic interface (PANEL / SIO).....	33
6.3.1	Pin assignment.....	34
6.3.2	Cable and plug specification.....	34
6.4	CAN interface (CAN0).....	34
6.4.1	Pin assignment, connection example.....	35
6.4.2	Cable and plug specification.....	35
6.4.3	CAN bus termination.....	35
6.5	Gigabit Ethernet interface (ETHERNET0).....	36
6.5.1	Pin assignment.....	36
6.5.2	Cable and plug specification.....	36
6.6	sercos III interface.....	36
6.6.1	Pin assignment.....	37
6.6.2	Cable and plug specification.....	37
6.7	USB ports.....	37
6.7.1	Cable and plug specification.....	38
6.8	EMC and wiring guidelines.....	38
<b>7</b>	<b>Configuration.....</b>	<b>39</b>
<b>8</b>	<b>Operating behavior.....</b>	<b>40</b>
8.1	Failure of supply voltage.....	40
8.2	Response to module errors.....	40
8.3	System watchdog.....	40
8.4	K-Bus watchdog.....	40
8.5	Temperature monitoring.....	40
8.6	Battery monitoring.....	41
8.7	System backup, firmware update.....	41
<b>9</b>	<b>Diagnosis.....</b>	<b>42</b>
9.1	Operating states.....	42
9.2	Switching between operating states.....	42
<b>10</b>	<b>Maintenance instructions.....</b>	<b>45</b>
10.1	Battery.....	45
10.1.1	Battery type and service life.....	45
10.1.2	Replacing the battery.....	45
<b>11</b>	<b>Disposal.....</b>	<b>46</b>
11.1	Disposal of the module.....	46
11.2	Disposal of the battery.....	46
<b>12</b>	<b>Technical data.....</b>	<b>47</b>
12.1	In general.....	47

---

12.2	Environmental conditions.....	47
12.3	Computer kernel.....	47
12.4	Interfaces.....	47
12.5	Dimensions, weight.....	48
<b>13</b>	<b>EC directives and standards.....</b>	<b>49</b>
13.1	EC directives.....	49
13.2	Standards.....	49
13.2.1	General procedures and safety principles.....	49
13.2.2	EMC guideline.....	49
13.2.3	Electrical safety and fire protection.....	49
13.2.4	Environmental and surrounding conditions.....	49
13.3	Standards for the American market.....	49
13.3.1	UL test for industrial control equipment.....	49
<b>14</b>	<b>Declaration of conformity.....</b>	<b>50</b>



# 1 Introduction

## 1.1 Purpose of the document

This document describes the structure of the CP 240/B (CPU module).

Additionally, the installation and configuration is described enough to obtain an operationally ready module. "Ready for operation" means that the assembly is ready for the synchronization of the firmware and the application.

### **Information**

*This manual is not addressed to end costumers! Necessary safety notes for the end costumer have to be taken into the costumer manual in the respective national language by the machine builders and system providers.*

## 1.2 Preconditions

This document contains information for persons with the following skills:

Target group	Knowledge and skills pre-requirement
Project engineer	<p>Basic technical training (University of Applied Science/University level, engineering degree or corresponding professional experience).</p> <p>Knowledge in:</p> <ul style="list-style-type: none"> <li>• working mode of a PLC,</li> <li>• current valid safety regulations,</li> <li>• the application.</li> </ul>
Electrician	<p>Specialized training in the electro-technical field (in accordance with industrial training guidelines).</p> <p>Knowledge in:</p> <ul style="list-style-type: none"> <li>• current valid safety regulations,</li> <li>• wiring guidelines,</li> <li>• circuit diagrams,</li> <li>• correct installation of electrical connections according to national and international regulations.</li> </ul>

Target group	Knowledge and skills pre-requirement
Start-up technician	Basic technical training (Vocational high school, engineering degree or corresponding professional experience). Knowledge in: <ul style="list-style-type: none"> <li>• current valid safety regulations,</li> <li>• working mode of machine or plant,</li> <li>• principal functions of the application,</li> <li>• system analysis and troubleshooting,</li> <li>• setting options at the operating installations.</li> </ul>
Service technician	Basic technical training (Vocational high school, engineering degree or corresponding professional experience). Knowledge in: <ul style="list-style-type: none"> <li>• working mode of a PLC,</li> <li>• current valid safety regulations,</li> <li>• working mode of machine or plant,</li> <li>• diagnosis possibilities,</li> <li>• systematic error analysis and rectification.</li> </ul>

### 1.3 Intended use

The CP 240/B was developed for control applications in industrial machines. The typical applications areas include injection molding machines, robots, presses, machine tools and similar.

The CP 240/B may only be used for the types of use described in the technical descriptions and in compliance with described technical general conditions. The CP 240/B may only be used in conjunction with recommended/approved third-party equipment/installations.

The CP 240/B has been developed, manufactured, tested and documented in accordance with the appropriate guidelines and standards. Therefore, the products do not pose any danger to the health of persons or a risk of damage to other property or equipment under normal circumstances, provided that the instructions and safety precautions are properly observed.

### 1.4 Notes on this document

This manual is integral part of the product. It is to be retained over the entire life cycle of the product and should be forwarded to any subsequent owners or users of the product.

#### 1.4.1 Contents of the document

- Description of the module
- Mounting and installation instructions
- Description of interfaces including EMC guidelines

- Configuration
- Operating behavior
- Diagnostics functions
- Maintenance instructions
- Technical data

#### 1.4.2 Not contained in this document

- Programming instruction
- Application diagnosis
- Firmware description

### 1.5 Documentation for further reading

The following documents are to be observed depending on the system solution used:

Doc.No.	Name	Target group
DE: 1000868 EN: 1000869	System manual Kemro automation system	<ul style="list-style-type: none"> <li>• Project engineer</li> <li>• Electrician</li> <li>• Programmer</li> <li>• Commissioning foreman</li> <li>• Service technician</li> </ul>

### 1.6 EtherCAT declaration



EtherCAT® is registered trademark and patented technology, licensed by Beckhoff Automation GmbH, Germany .

## 2 Safety notes

### 2.1 Representation

At various points in this manual you will see notes and precautionary warnings regarding possible hazards. The symbols used have the following meaning:



---

**DANGER!**

- indicates an imminently hazardous situation which will result in death or serious bodily injury if the corresponding precautions are not taken.
- 



---

**WARNING!**

- indicates a potentially hazardous situation which can result in death or serious bodily injury if the corresponding precautions are not taken.
- 



---

**CAUTION!**

- means that if the corresponding safety measures are not taken, a potentially hazardous situation can occur that may result in property injury or slight bodily injury.
- 

---

**CAUTION**

- CAUTION used without the safety alert symbol indicates a potentially hazardous situation which, if not avoided, may result in damage to property.
- 



- This symbol reminds you of the possible consequences of touching electrostatically sensitive components.
- 

---

**Information**

*Useful practical tips and information on the use of equipment are identified by the "Information" symbol. They do not contain any information that warns about potentially dangerous or harmful functions.*

---

## 2.2 General safety instructions



---

### WARNING!

- It is absolutely essential that you also observe the safety instructions in the system manual for your automation system.
  - The following areas of application are expressly excluded for the CPU module:
    - Use in areas where there is a risk of explosion or fire
    - Use in the mining sector
    - Use in the open airOther products are to be used for these applications!
  - The CPU module is not designed for safety-relevant control tasks (e.g.: shutdown in case of an emergency). For safety-relevant control tasks and personnel security, additional external safety measures must be implemented to ensure the system remains in a safe operating condition even in the event of a fault.
  - At the development of the CPU module the standard EN ISO 13849-1 was not considered.
  - The module is defined as "open type equipment" (UL 508) or as "open equipment" (EN 61131-2) and must therefore be installed in a control cabinet.
- 

### CAUTION

Improper use of the assembly or the control system leads to irreparable damage!

- Turn off the power supply before inserting or removing the module. Otherwise, the module can be destroyed or undefined signal states can lead to damage of the control system.
- 

## 2.3 Safety instructions for personal safety



---

### WARNING!

Danger of personal injury due to electric shock!

- Supply the device exclusively from power sources that have an extra low voltage (e.g. SELV or PELV according to EN 61131-2)
  - When using a SELV power source it can become PELV by reason of the module construction and the connectors (grounding!).
  - Protective low voltage circuits must always be installed safely insulated separated from circuits with dangerous voltage.
-

**CAUTION!**

Fire hazard during module failure!

- Provide suitable fuses for the 24 V DC power supply of the control system for the final application! (for details, refer to the Power supply section).
- 

## 2.4 Safety instructions for device maintenance

**CAUTION!**

- The device may only be opened by qualified personnel and only maintenance activities expressly approved by KEBA may be performed (see chapter “maintenance”). Any other manipulations to the device will result in loss of warranty.
  - If this device is damaged, the device must be taken out of commission and repaired or replaced by qualified personnel.
-

### 3 Description of the module

The CPU module is an intelligent master module designed for a medium-range performance within the Kemro automation system.

1 slot for an option module is available for extension.

#### 3.1 Front view

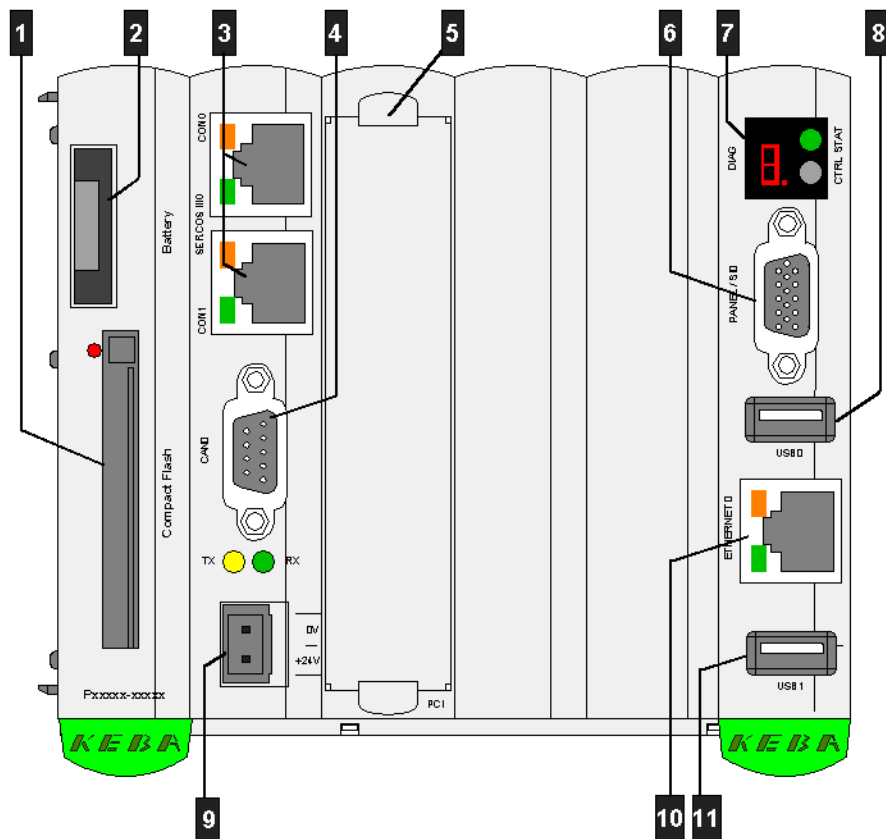

Fig.3-1: CP 240/B Front view

<b>1</b> ... Compact Flash	<b>2</b> ... Battery case
<b>3</b> ... SERCOS III interface	<b>4</b> ... CAN interface
<b>5</b> ... 1 slot for a PCI option module	<b>6</b> ... Graphic interface
<b>7</b> ... Diagnosis display	<b>8</b> ... USB port 0
<b>9</b> ... Power input	<b>10</b> ... Ethernet interface
<b>11</b> ... USB port 1	

## 3.2 Side view

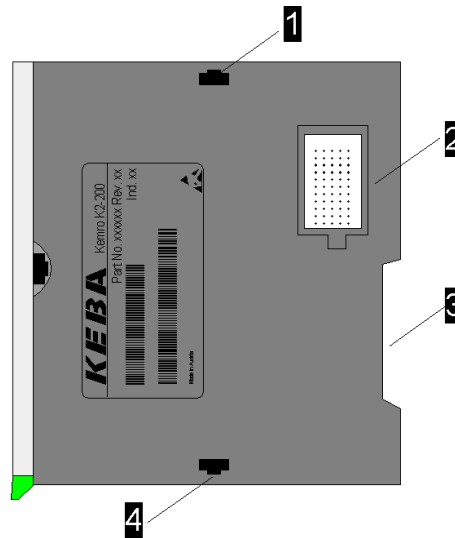

Fig.3-2: CP 240/B side view

<b>1</b> ... Upper snap for mechanical connection of the modules	<b>2</b> ... K-Bus plug
<b>3</b> ... Cutout for mounting rail	<b>4</b> ... Lower snap for mechanical connection of the modules

## 3.3 Compact Flash slot

To operate a Compact Flash card with the respective firmware and the application must be plugged into the Compact Flash slot of the CPU module. Depending on the application used the Compact Flash card can also be used for storing machine data (e.g. mold data or part data).

### **Information**

*Use only Compact Flash cards which are recommended by KEBA.*

### **Information**

*The Compact Flash Card cannot be used as removable medium since it also has system programs stored on it.*

### 3.3.1 Precautions when using the CF card

---

#### CAUTION

Improper insertion can cause damage to the contact pins.

Do not use force when inserting the Compact Flash card into the slot. It is constructed so that it can only be inserted in one direction and it should slide into the slot easily with little force.

The card:

- should be kept away from moisture, heat and direct sunlight,
  - should be protected against static electricity,
  - should not be dropped or bent.
  - should not be removed or the device switched off while the card is being written to.
- 

### 3.3.2 Inserting the Compact Flash card

- 1) Turn off the power supply.
- 2) Insert the Compact Flash card (see drawing).

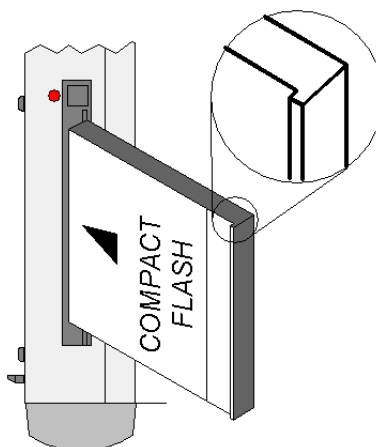

---

Fig.3-3: Inserting the CF card

### 3.3.3 Removing the Compact Flash card

- 1) Turn off the power supply.
- 2) Press the eject button ( **1**, see drawing).
- 3) Pull out the Compact Flash card ( **2**).

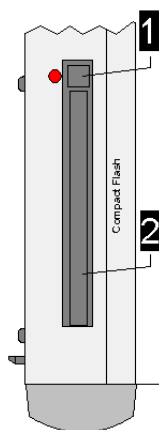

Fig.3-4: Removing the CF card

## 3.4 Accessories

### 3.4.1 Compact Flash card

The recommended Compact Flash cards may be requested and ordered from KEBA.

### 3.4.2 Connector strip

Socket board	Color	Number	Weidmüller order number
2-pole	sw	1	BLZF 5.08/2 SN SW - 1707690000

The appropriate female connectors are not included in the delivery of KEBA, but can be purchased from KEBA.

The technical data for the terminals are contained in the technical data sheet of the manufacturer of the female connectors.

## 4 Displays and operating elements

### 4.1 Diagnostic display (DIAG)

A single-digit 7-segment display on the front side of the CPU modules indicates the start-up and operating modes.



Fig.4-1: 7-segment display

The following applies in general for the 7-segment display (on CPU-modules):

- Numbers >0 during the start-up denote the progress
- Different characters (e.g. □, II, ...) or capital letters denote the operating status after start-up
- The decimal point serves as load display. A flashing decimal point signals that the CPU's load capacity is not fully exhausted.
- Errors are displayed parallel to the states.
- Errors are always signaled by a switching-through the status and a double or triple-digit error/info sequence (e.g. "-,0,-,E,1,0"). Every character is displayed for 1 second.

For further information see chapter "Diagnosis".

### 4.2 Status LEDs

The multi-colored status LED on the CPU module is located above the control key (CTRL).

Display	Significance
Dark	No supply voltage
Flashing green	Initialization phase
Green	Operation
Flashing red	Error on module (e.g. overload, line interruption, etc.)
Red	Fatal module error – the module is out of operation.

### 4.3 Control key (CTRL)

The CTRL key is located next to the 7-segment-display on the right and serves as simple operating element on the module. With this key the CP 240/B can be switched into different operating modes and/or different commands can be issued.

- Distinction is made between short (< 0.5 s), long (> 0.5 s, <10 s) and very long key operations (>10 s).
- Short keystrokes allow the user to switch and selected between the individual commands, while these commands are displayed by flashing in the 7-segment display. Once the initial status has been reached again this will be indicated normally again.
- Long keystrokes are used to execute a command and to change into the new status.
- If the CTRL key is held pressed longer than 10 seconds, a hardware reset of the module is triggered.

During start-up (including step "3" indicated at the diagnosis display) this key has no function.

#### 4.4 CAN Status LEDs

The module has two CAN Status LEDs (RX- and TX-LEDs) per CAN interface, which are activated from the Microcontroller.

Display	Significance
RX-LED (green)	briefly lights up on receipt of a CAN-message.
TX-LED (yellow)	briefly lights up on transmission of a CAN-message.

#### 4.5 Ethernet Gbit Status LEDs

The Ethernet socket (RJ-45) has one Link/Activity LED and one Speed LED.

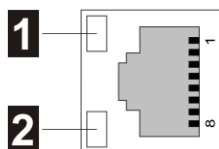

Fig.4-2: Position of the status LEDs

LED	Display and meaning
<b>1</b> ... Link/Activity LED (green)	Indicates if there is a connection and lights up on sending and receiving. Modes: <ul style="list-style-type: none"> <li>• Off: No connection</li> <li>• Green steady: Connection exists</li> <li>• Green blinking: Transmitting data</li> </ul>
<b>2</b> ... Speed LED (yellow/green)	Shows the current transmission rate speed. Modes: <ul style="list-style-type: none"> <li>• Off: 10 Mbit/s</li> <li>• Green: 100 Mbit/s</li> <li>• Yellow: 1 Gbit/s</li> </ul>

### 4.6 SERCOS III status LEDs

The module has two status LEDs (Line and Activity) per SERCOS III interface.

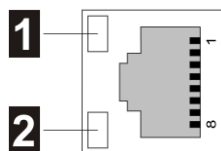

Fig.4-3: Position of the status LEDs

LED	Meaning
<b>1</b> ... Activity (yellow, left)	Lights up when sending and receiving data.
<b>2</b> ... Line (green, right)	Lights up as soon as a connection is alive.

## 5 Mounting and installation instructions

The CP 240/B is designed for horizontal installation in a control cabinet on a mounting rail. For the adoption to various different interfaces, option modules can be inserted into the CPU-modules. The devices communicate via internal system bus (K-Bus). The cycle time of the system bus is 1 ms.

Up to 12 modules (I/O-, technology or field bus modules) of the KeConnect series can be lined up next to each other to the right side of the CPU module.

### 5.1 General instructions on assembly and removal

---

#### CAUTION

Improper handling can damage the modules, option modules and the control system.

- Switch off the operating and on-load power supply before carrying out assembly, installation or maintenance work.
- 

#### CAUTION

Damage to components!

Handle all modules and components with care. Please ensure the following:

- Clean contact surfaces (to avoid contact faults).
  - Bus plugs that are not bent.
  - Ensure that no pieces of wires, fillings or swarf fall into the unit when you are drilling holes or connecting wires.
- 

Detailed information concerning assembly and removal as well as dimensions and minimum distances can be found in the corresponding project engineering manual.

### 5.2 Inserting and removing of option modules

The front side of the CP 240/B provides a slot for the option modules. A module from the KeConnect series can be inserted into this slot.



Fig.5-1: Assignment of the slot

**1** ... Slot for option modules



- **Slots not used must be closed with reserve modules to secure contact protection of the ESD-sensitive parts.**

### **Information**

*The option modules may not be plugged or removed, if the CP 240/B is activated.*

For further information on connection and operation: Refer to the Project Engineering Manuals of the option modules used.

### **Inserting an option module into slot**

- 1) Turn off power supply
- 2) Remove dummy module
- 3) Insert module in the right position (labeling of option module must on the right) into the intended position (see image).

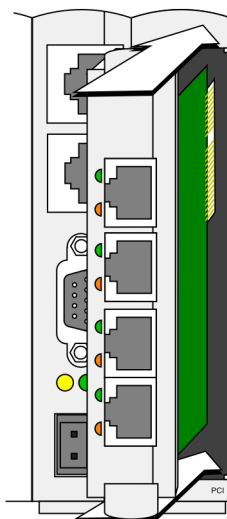

Fig.5-2: Inserting the option module into slot

**Removing an option module**

- 1) Turn off power supply
- 2) Pull module out of the slot
- 3) Insert dummy module.

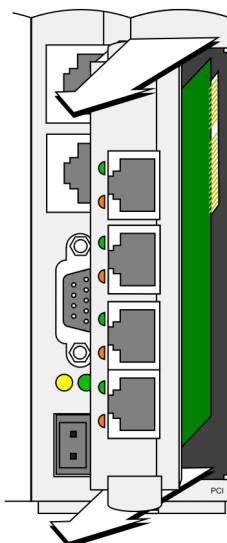

Fig.5-3: Removing the option module

**5.3 Adding modules**

The CP 240/B makes the power supply available for up to 12 add-on modules. The connection between CP 240/B and the added modules is established via a parallel K-Bus. The entire package is snapped onto a mounting rail (mounting rail TS 35x7,5).

To guarantee stable functioning of the module cluster the total power demand ("Power consumption 5 V on the K-Bus" and "Power consumption 24 V on the K-Bus") on the added-on modules must not exceed the power values (Max. output power K-Bus 5 V" and "Max. output power K-Bus 24 V") of the CP 240/B specified in the technical data.

### Information

*For the calculation of the number of modules that can be added, the performance values specified in the technical data of the respective project engineering manual under "Power consumption 5 V on the K-Bus" and "Power consumption 24 V on the K-Bus" must be used.*

To add modules, their module address has to be set first.

### 5.3.1 Setting the module address

The modules in the system are addressed by means of a 16-position address switch. All modules within a device package thus can be differentiated.

A device package consists of an CP 240/B and added modules.

The address switch is located on the side of the modules, underneath the K-Bus plug. Prior to the assembly of the package the address must be set to the position configured in the application software.



### CAUTION!

- Attention must be given when setting the address switch with the screwdriver that none of the surrounding components is damaged.

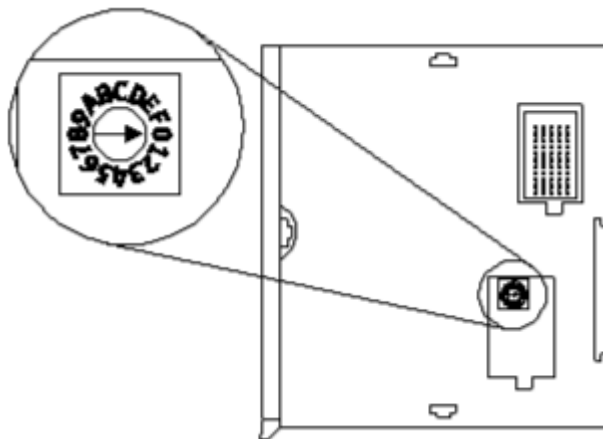

Fig.5-4: Settings of the address switch

**Information**

*Modules of the same type must have different address switch positions within one device package. Different modules in different device packages may have the same address switch positions.*

**5.3.2 Plugging modules together**

Extension modules are lined up on the right side of the CP 240/B. For this purpose the side lid must be removed from the left module (CP 240/B or extension module) in each case and the extension module has to be plugged.

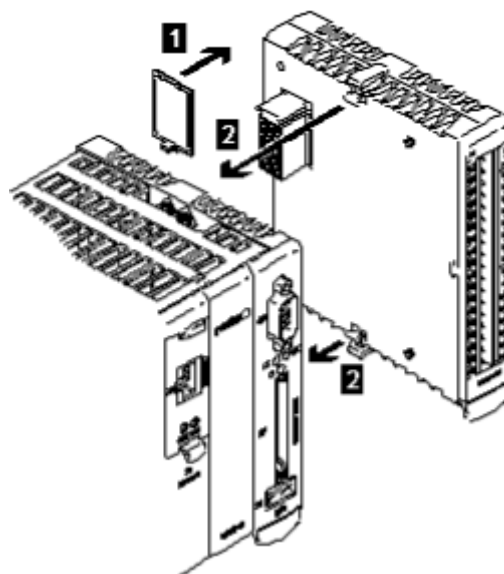

Fig.5-5: Plugging modules together

<b>1</b>	... Side lid
<b>2</b>	... locking pins

**Information**

*When adding extension modules to an already given module make sure that the locking pins are properly engaged.*

*Furthermore, ensure that the entire package (CP 240/B and add-on modules) is secured on either side with device end clamps to prevent it from being displaced and/or protected against vibration.*

*At the extreme right extension module the K-Bus plug has to be covered with the side lid.*

*If the package is not mounted properly, its function may be impaired.*

### 5.4 Removing added modules

To remove extension modules the lockings at the top and at the bottom of the module have to be pressed first and then the module can be removed. Subsequently the connector opening for the K-Bus plug has to be covered with the side lid.

**CAUTION**

Without pressing the lockings they will break by removing the module.

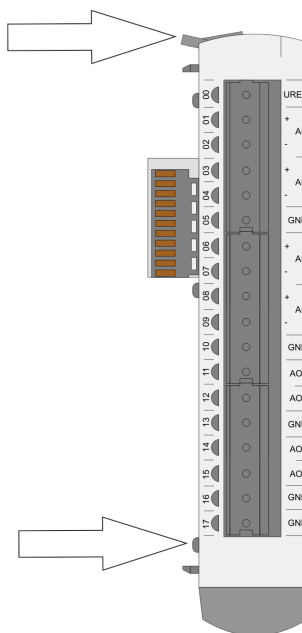

Fig.5-6: Lockings of the module

### 5.5 Mounting rail

A steel rail TS 35x7.5 is to be used as mounting rail for the device. For the sake of stability the screw distance, as shown in the illustration, must not exceed 100 - 120 mm.

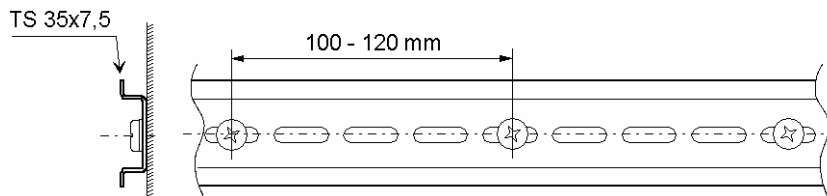

Fig.5-7: Fixing of the mounting rail.

## 5.6 Space requirement

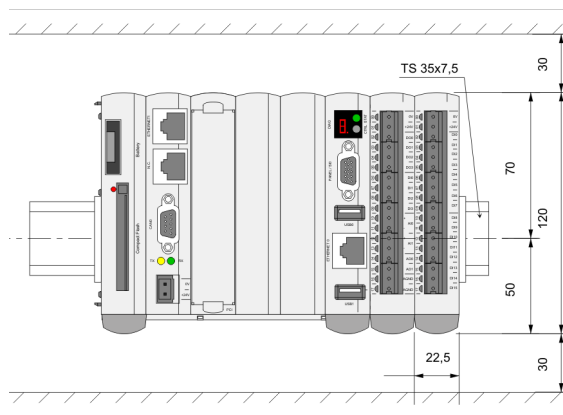

Fig.5-8: Mounting sketch

### Information

- *Free space for air circulation: At least 30 mm above and below the modules.*

## 5.7 Installing the module

### CAUTION

#### Mounting orientation:

The only permissible way to install the mounting rail is that the front side of the mounted module is directed ahead and the ventilation holes are directed upwards and downwards (see the following graphics). Otherwise defects (e.g. by means of heat accumulation) may occur (see also [chapter 5.9 "Air conditioning and ventilation" on page 30](#)).

This is how the module is installed on the mounting rail:

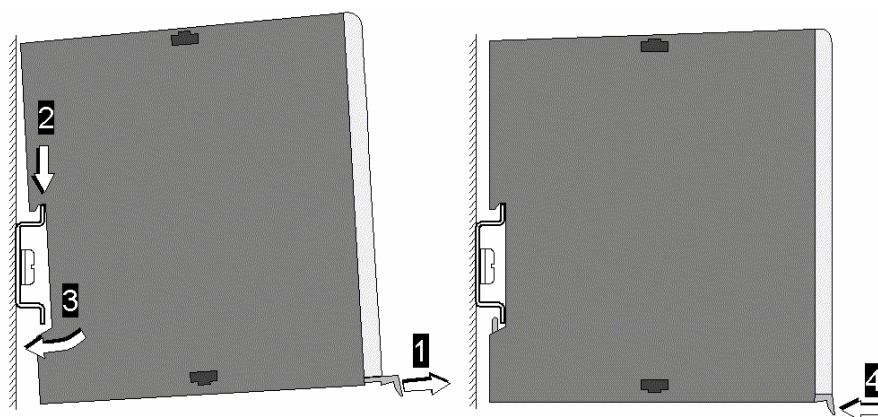

Fig.5-9: Installation on a mounting rail

- 1) Pull out (unlock) all locking levers on the mounting rail.
- 2) Slightly incline the module and place on the fixture of the mounting rail.
- 3) Press the lower half of the module onto the mounting rail.
- 4) Lock all locking levers on the mounting rail one after the other.
- 5) Secure the modules with the end brackets against slipping or loosening due to vibration (see [chapter 5.7.1 "End bracket" on page 29](#)).

The module is now installed on the mounting rail. You can now wire-connect the interfaces and the inputs/outputs.

### 5.7.1 End bracket

To prevent the modules from slipping or loosening through vibration, an end bracket must be mounted on the left and right side of the mounting rail.

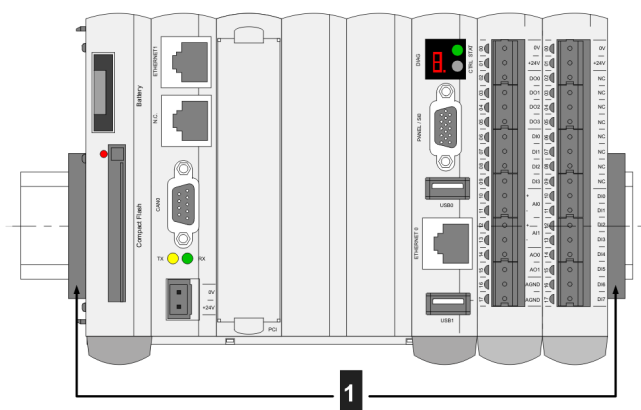

Fig.5-10: End fixture plates

**1** ... End bracket

## 5.8 Removing the module

---

### CAUTION

Risk of damaging components during installation work under voltage.

- Therefore, switch off the power supply and remove all cable connections prior to starting dismantling work.

- 
- 1) Turn off power supply
  - 2) Disconnect all cable connections on the module
  - 3) Pull out (unlock) all locking levers on the mounting rail.
  - 4) Remove the module from the mounting rail.

## 5.9 Air conditioning and ventilation

Ventilation holes for dissipating the heat are placed at the top and underside of the module. If the permissible ambient temperature is not exceeded, no external fan will be needed. Make sure that the ventilation holes are not covered.



---

### CAUTION!

High temperatures may destroy the module!

- The operating temperature inside the control cabinet must not be higher than the permissible ambient temperature of the module. If this cannot be guaranteed through natural heat dissipation, an air conditioning of the control cabinet must be provided.
- When installed in a control cabinet attention must be given that the area around the inputs for thermocouples is not exposed to any temperature changes. (e.g. no air conditioners with intermittent operating hours)

---

#### **Information**

*There must be a free space of at least 30 mm above and below the modules to guarantee head dissipation.*

### 5.9.1 Use of air filters

To ensure that the contamination does not exceed contamination level 2 (according to EN 61131-2), the device must be installed in a dustproof, closed control cabinet. Fan openings of the control cabinet must be equipped with air filters. The filter elements must be cleaned or replaced regularly.

---

#### **Information**

*Contamination level 2, description according to standard:*

*"The occurring contamination is generally not conductive. However, temporary conductivity must be expected due to condensation."*

## 6 Connections and wiring

### 6.1 Power supply

The 24 V terminal energizes the CP 240/B and all add-on modules.



---

#### **WARNING!**

**Danger of personal injury due to electric shock!**

- Supply the device exclusively from power sources that have an extra low voltage (e.g. SELV or PELV according to EN 61131-2)
  - When using a SELV power source it can become PELV by reason of the module construction and the connectors (grounding!).
  - Protective low voltage circuits must always be installed safely insulated separated from circuits with dangerous voltage.
- 



---

#### **CAUTION!**

**Fire hazard during module failure!**

- External line fuse with maximum 10 A must be provided in the final application.
- 

#### **Section**

Refer to the manufacturer-specific data sheet of the of the female connectors used for type, cross-section and material. For further information: See chapter Accessories.

The actual permissible wire cross-section is specified by the electrical conditions of the connected equipment an the female connectors used:

- Max. load current and required heat dissipation through the connected wire at maximum ambient temperature.
- Permissible voltage drop for error-free operation of the connected equipment.

### 6.1.1 Connection example

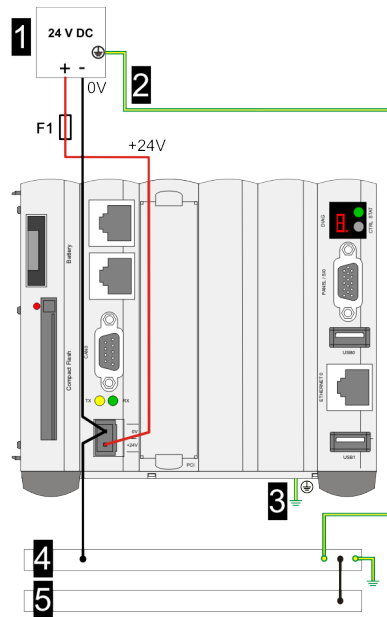

Fig.6-1: Connection of the power supply

<b>1</b> ... DC supply	<b>2</b> ... Grounding in green/yellow
<b>3</b> ... Grounding point of the housing	<b>4</b> ... Ground rail
<b>5</b> ... Shield rail	

#### Fuse F1

The rated current for fuse F1 is dependent on the power consumption of the added-on modules.

## 6.2 Grounding

If required for reasons of electrical safety for the end usage, the metal parts of the module have to be grounded via the threaded bushing (M4) that is located on the bottom side of the enclosure (grounding point with ground icon).

### CAUTION

**Do not use too long screws (max. thread length 5 mm ), because they can destroy elements within the module.**

Material: Electrolytic galvanized sheet steel, blue galvanized self-clinching standoff.

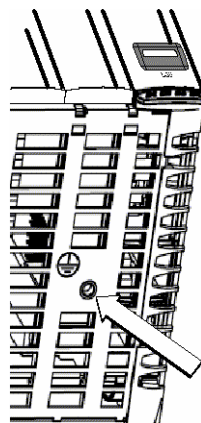

Fig.6-2: Example: grounding point on the enclosure

### 6.3 Graphic interface (PANEL / SI0)

The graphic interface is used to connect an operating panel.

A list of the panels which are compatible with the CP 240/B can be requested from KEBA.

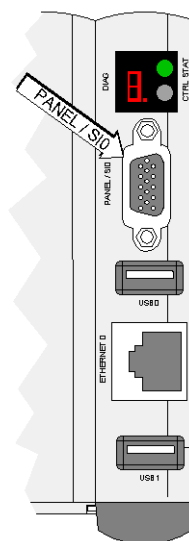
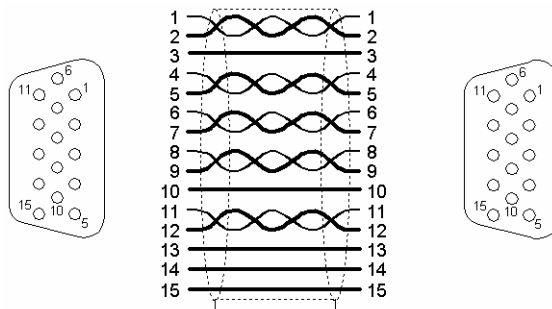

Fig.6-3: Position of the graphic interface

### 6.3.1 Pin assignment



<b>01</b> ... CLK+ (Pair 1)	<b>02</b> ... CLK- (Pair 1)
<b>03</b> ... +5 V	<b>04</b> ... RS485+ (pair 2)
<b>05</b> ... RS485- (pair 2)	<b>06</b> ... DATA0+ (Pair 3)
<b>07</b> ... DATA0- (Pair 3)	<b>08</b> ... DATA1+ (Pair 4)
<b>09</b> ... DATA1- (Pair 4)	<b>10</b> ... GND (connect via free line or via cable shield)
<b>11</b> ... DATA2+ (Pair 5)	<b>12</b> ... DATA2- (Pair 5)
<b>13</b> ... SDA	<b>14</b> ... SDC
<b>15</b> ... Panel-present	

### 6.3.2 Cable and plug specification

Further information: See system manual.

### 6.4 CAN interface (CAN0)

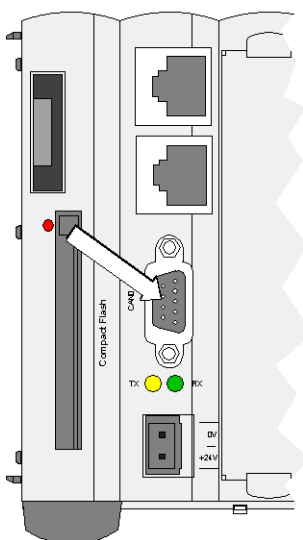

Fig.6-4: Position of the CAN interface

### 6.4.1 Pin assignment, connection example

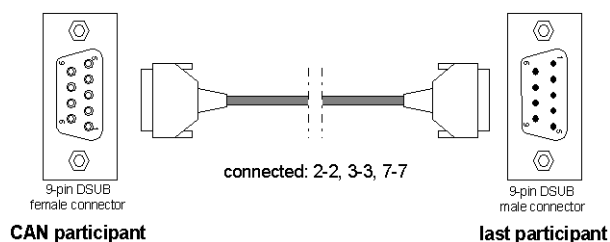

Fig.6-5: CAN connection at the module: 9-pole D-SUB male connector

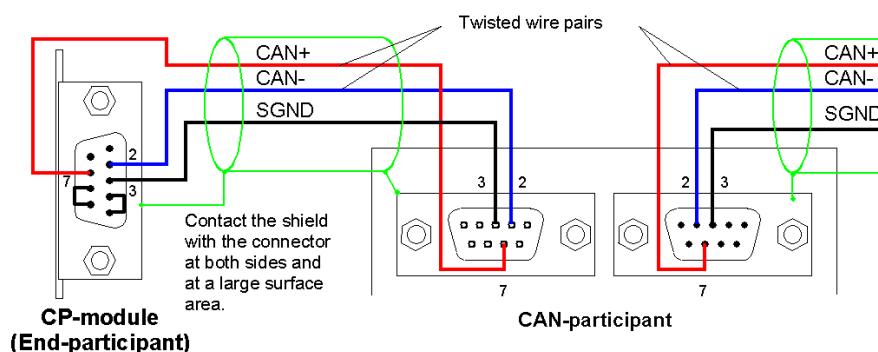

Fig.6-6: Connection example for CAN circuit

<b>2</b> ... CAN-	<b>3</b> ... SGND
<b>7</b> ... CAN+	

**Information**

Both SGND (Signal Ground) and GND (optional ground) connections are connected internally. The designation was selected to correspond with the standard CiA® (CAN in Automation).

Further information: See system manual.

### 6.4.2 Cable and plug specification

Further information: See system manual.

### 6.4.3 CAN bus termination

To activate the bus termination at the first and last participant, both the pins 4 and 5 (TERM1) must be connected as well as the pins 8 and 9 (TERM2).

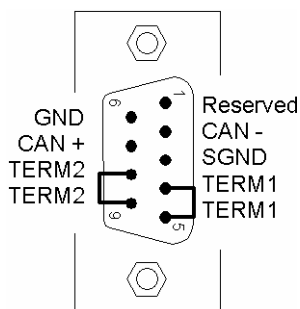

Fig.6-7: CAN interface with activated bus termination

## 6.5 Gigabit Ethernet interface (ETHERNET0)

### 6.5.1 Pin assignment

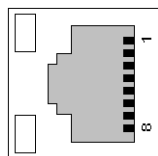

Fig.6-8: Ethernet connector

Pin-No.	Signal designation
1	MX 0+
2	MX 0-
3	MX 1+
4	MX 2+
5	MX 2-
6	MX 1-
7	MX 3+
8	MX 3-

### 6.5.2 Cable and plug specification

Further information: See system manual.

## 6.6 sercos III interface

sercos III is the third generation sercos interface series according to IEC/EN 61491 based on standard Ethernet IEEE 802.3.

### 6.6.1 Pin assignment

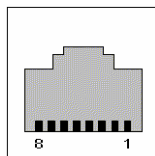

Fig.6-9: RJ45 plug

Pin no.	Signal designation		Input / Output
1	Tr. Data +	Transmit Data +	Output
2	Tr. Data -	Transmit Data -	Output
3	Re. Data +	Receive Data +	Input
4	n.c.	n.c.	---
5	n.c.	n.c.	---
6	Re. Data-	Receive Data -	Input
7	n.c.	n.c.	---
8	n.c.	n.c.	---

### 6.6.2 Cable and plug specification

Further information: See system manual.

## 6.7 USB ports

For the connection of external USB devices (USB 2.0 High Speed) 2 ports are available.

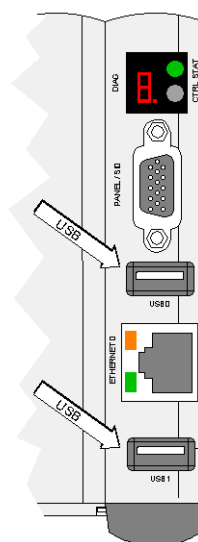

Fig.6-10: Position of the USB ports

---

**CAUTION**

- The use of common USB devices may result in unexpected system behavior or system failures, as these devices are not normally designed for operation in an environment with industrial interference.
  - Never keep USB-devices constantly connected, as the USB-ports are not operationally reliable (danger of unplugging).
  - For constant operations use a strain relief.
- 

**6.7.1 Cable and plug specification**

Further information: See system manual.

**6.8 EMC and wiring guidelines**

Pay attention from the outset to careful wiring and shielding.

Further information: See system manual.

## 7 Configuration

### **General information for configure devices**

A Kemro automation system needs data for the configuration of system performance, its I/O-devices and interfaces. The system reads this data during the start-up operation and allocates them to its components and devices.

Configuration data is created by included configuration tools or by editing configuration files.

For further information to the configuration see the documentation of the included configuration tool.

## 8 Operating behavior

### 8.1 Failure of supply voltage

In case of a complete power supply failure a Reset is triggered. All lined-up modules are also set into reset-status and all outputs are switched off.

Data in the battery-buffered SRAM remain intact and the real-time clock continues to run.

### 8.2 Response to module errors

In case an error occurs, this error will be displayed on the diagnosis display on the front side of the CP 240/B.

Further information: See system manual.

### 8.3 System watchdog

In case of a module error an internal watchdog monitor will be triggered.

The following occurs:

- a system reset will be triggered,
- a K-Bus reset will be triggered (effect: see K-Bus watchdog) and
- a status report will be written.

### 8.4 K-Bus watchdog

If the cyclic K-Bus watchdog service fails, then all modules which are configured at the K-Bus will be resetted.

- All outputs of the IO modules will be shut off and the system will be set into a safe status.

### 8.5 Temperature monitoring

The CPU temperature of the CP 240/B and therefore it's environmental temperature is checked every second.

- If the temperature violates a **warning boundary**, a message will be sent and the application has the possibility to react.

---

**CAUTION**

If no appropriate measures were started, to avoid a further rising of the temperature, then the following hold of the control could lead to serious damage of the machine/plant.

---

If, in the following, the temperature sinks under the warning boundary, an OK message will be sent.

- If the temperature violates the **upper limit**, the system will be held within 5 seconds after the first violation.
  - The application has no possibility for any reaction.
  - The system will be set into a safe status.
  - The display shows a message (it displays the time, until the CPU module will hold) and
  - the diagnosis display of the CPU module indicates an error ("E").

## 8.6 Battery monitoring

Once a week the battery status of the CP 240/B will be checked. If the battery voltage is lower than a limit value, then a message will be triggered and the operator is requested to change the battery.

Information to battery change: See chapter 'Maintenance Instructions'.

## 8.7 System backup, firmware update

Further information: See system manual.

## 9 Diagnosis

The module has a 7-segment display for signalling status information and error codes.

During startup at the CP 240/B (up to status '3', which is displayed in the diagnosis display) the following error states are possible:

Error code	Significance
2 - E32	Hardware error
3 - E51	Compact Flash card is not available.

### 9.1 Operating states

During operation the control can be switched into the following operating states:

**Main operating states:**











State	Display	Description
INIT		The state "Init" is a service mode in which the start-up is stopped due to a serious system error (e.g. hardware error, etc.).  In this service mode, it is possible to execute certain actions (e.g. "clear-retain"). Under normal circumstances this state is switched through during the start-up. A run-time system has not been loaded in the "Init" state.
STOP		In this operating state the IEC application program is loaded, but there is no cyclical processing of the application. This is a safety state in which no application (IEC or robotics) can set outputs. That is why this state can only be exited locally via the CTRL key on the control but not remotely via the programming tool.
RUN		The application programs can be processed in this operating state. The process data are exchanged according to the configuration.

It is possible to switch between the operating states by pressing the CTRL key.



















### 9.2 Switching between operating states

**INIT**







Status displayed	Short keystroke	Long keystroke
 INIT: The control is in the status INIT	 To next action: Load application	
 Load application	 To next action: Delete retain data	 The control will enter the status "STOP".

Status displayed		Short keystroke		Long keystroke	
	Delete retain data and re-initialize		To next action: Delete application		The retain data are deleted and afterwards the system is newly initialized.
	Delete application		To next action: Write status report		The application is being deleted.
	Write status report		To next action: Trigger restart		Status report is being written.
	Trigger restart		On to main operating status INIT		A restart is being executed.

**STOP**

Status displayed		Short keystroke		Long keystroke	
	STOP: The control is in the status STOP		To next action: Starting the application		
	Starting the application		To next action: Unload application		The control will enter the status RUN.
	Unload application		To next action: Write status report		The control enters the status INIT.
	Delete retain data and re-initialize		To next action: Delete application		The retain data are deleted and afterwards the system is newly initialized.
	Delete application		To next action: Write status report		The application is being deleted.
	Write status report		To next action: Trigger restart		Status report is being written.
	Trigger restart		On to main operating status STOP		A restart is being executed

**RUN**

Status displayed		Short keystroke		Long keystroke	
	RUN: The control is in the status RUN		To next action: Stop control.		
	Stop control		To next action: Write status report		The control will enter the status STOP
	Write status report		On to main operating status RUN		Status report is being written.

**Example: Delete retain data:**

The function "Delete retain data" can only be triggered in the main operating status INIT.

Sequence:

- 1) Click through the functions by using short keystrokes, until the diagnosis display  is shown.
- 2) Start deleting of retain data with a long keystroke.
- 3) Once the retain data has been deleted, the system will automatically return to the main operating mode INIT.

## 10 Maintenance instructions

### 10.1 Battery

#### 10.1.1 Battery type and service life

Battery type:	CR2032 (Lithium-Mn, 3 V/220 mAh)
Service life:	min. 3 years, typically 5 years

#### 10.1.2 Replacing the battery

---

##### CAUTION

- Do not use force!
  - Improper exchange of the battery, replacement of the battery by a different type or non-observance of the polarity can lead to irreparable damage to the battery.
  - New batteries should not be touched with bare fingers because this could cause contact problems due to oxidation.
  - If the battery is not replaced when there is a warning message, the data of the SRAM can be lost if the power supply is interrupted.
- 

The battery is located in the battery case in the front panel.

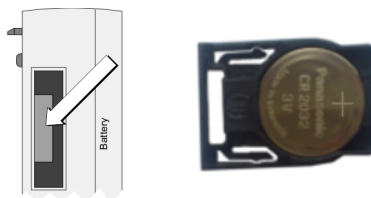

---

Fig.10-1: Position and view of battery case

- 1) To prevent a loss of data, the **power supply** must not be disconnected when replacing the battery.
  - 2) Remove battery case.
  - 3) Remove old battery and replace it with new battery. **Pay attention to polarity!**
  - 4) Re-insert battery case into CP 240/B.
- 

##### CAUTION

- If the battery is inserted incorrectly, the retain data is lost if the front panel power supply is interrupted.
-

## 11 Disposal

### 11.1 Disposal of the module

---

#### CAUTION

Please observe the regulations regarding disposal of electric appliances and electronic devices!

---



- The symbol with the crossed-out waste container means that electrical and electronic devices including their accessories must not be disposed of in the household garbage.
- The materials are recyclable in accordance with their labeling. You can make an important contribution to protecting our environment by reusing, renewing and recycling materials and old appliances.

### 11.2 Disposal of the battery

---

#### CAUTION

- Pay attention to hazardous waste regulations when disposing of batteries.
  - Although batteries have a low voltage, they can provide enough current when short-circuited to ignite flammable material. They should not be disposed of together with conductive material (e.g. iron filings, wire wool contaminated with oil, etc.)
-

## 12 Technical data

### 12.1 In general

Power supply voltage:	24 V DC
Max. switch-on current:	5.5 A
Overvoltage category:	II
Equipment class:	III according to EN 61131-2
Galvanic isolation:	No
Max. total power consumption:	75 W
Power consumption own consumption:	17 W (without PCI option module *)
Max. output power K-Bus 24 V:	45 W (max. 2 A)
Max. output power K-Bus 5 V:	10 W (without PCI option module *)
Fan:	Without fan
Ingress protection rating:	IP20

\*)

#### **Information**

*If a PCI option module is plugged in, then the available output power (at K-Bus 5 V) is reduced by the power consumption of the option module.*

### 12.2 Environmental conditions

Operating temperature:	+5 °C to +55 °C
Storage temperature:	-40 °C to +70 °C
Relative humidity of air:	10 % to 95 % (non condensing)
Vibration resistance:	according to EN 61131-2:2007
Shock resistance:	according to EN 61131-2:2007

### 12.3 Computer kernel

Processor:	Emb. Processor Intel ATOM Z510 600 MHz
Memory:	512 MB DDR2-SDRAM
Battery-buffered SRAM:	1 MB

### 12.4 Interfaces

CAN interface (onboard):	1
• Data transmission rate:	Setting via software (125 kbit/s to 1 Mbit/s)
• Terminating resistor:	Yes, can be bridged in plug
• Galvanic isolation:	no

• Connection:	DSUB 9-pin pin plug
Ethernet:	1
• Data transmission rate:	100/1000 MBit
• Galvanic isolation:	Yes, signaling lines
sercos III:	2
USB:	2
	USB 2.0 high speed.
Compact Flash:	Type 1
Plugging PCI interface:	For Kemro Ethernet option module
K-Bus:	At the side; used for adding Kemro modules.
Graphic interface:	DVI (only für KEBA operating panels)

## 12.5 Dimensions, weight

Module height:	120 mm
Mounting width:	135 mm
Module depth:	100 mm
Weight:	960 g

## 13 EC directives and standards

### 13.1 EC directives

Guideline 2004/108/EG	EC guideline on electromagnetic compatibility
Guideline 2011/65/EU	RoHS guideline

### 13.2 Standards

To check the conformity of the system with the directives, the following non-binding legal European standards were applied:

#### 13.2.1 General procedures and safety principles

EN 61131-1:2003	Programmable controllers - Part 1
-----------------	-----------------------------------

##### **Information**

*This product was developed for the use in industrial areas and can cause radio interference when used in residential areas.*

#### 13.2.2 EMC guideline

EN 61131-2:2007	Programmable controllers - Part 2
-----------------	-----------------------------------

#### 13.2.3 Electrical safety and fire protection

EN 61131-2:2007	Programmable controllers - Part 2
-----------------	-----------------------------------

#### 13.2.4 Environmental and surrounding conditions

EN 61131-2:2007	Programmable controllers - Part 2
-----------------	-----------------------------------

### 13.3 Standards for the American market

#### 13.3.1 UL test for industrial control equipment

UL 508, 2005	Industrial Control Equipment
--------------	------------------------------

# 14 Declaration of conformity



**EC Declaration of Conformity**



KEBA AG  
 Gewerbepark Urfahr  
 4041 Linz  
 AUSTRIA

We declare that the following product(s) is/are in conformity with the essential requirements of the following European Council Directive(s).

Conformity to the directive(s) is/are assured by the compliance with the applicable parts of the described harmonized european standards.

Product group	Product	RL 2004/108/EC	EN 61131-2:2007	RL 2006/42/EC	EN ISO 13850:2008	EN 60204-1:2006	EN ISO 13849-1:2008	RL 1999/5/EC	RL 2011/65/EU
---------------	---------	----------------	-----------------	---------------	-------------------	-----------------	---------------------	--------------	---------------

PLCs	CP 03x/x	X	X						X
	CP 05x/x	X	X						X
	CP 23x/x	X	X						X
	CP 24x/x	X	X						X
	CP 25x/x	X	X						X
	CP 285/x	X	X						X
	CP 3xx/x	X	X						X

x ... variant suffix

**Important notes:**

This document is only an overview and not the original declaration of conformity. The original declarations of conformity can be requested from KEBA.

Any modification on the product(s), that is performed without KEBA's consent will render this declaration invalid. The safety instructions contained in the documentation supplied with the product(s) must implicitly be followed!