

1/16 DIN, Single Preset Counter with Four-Digit LED Display

- Choose from UP, DOWN and reversible counting
- Count speed up to 5 K counts per second
- Wide-range AC or DC supply voltages
- Contact and solid-state output models available
- Memory protection circuit available on AC models
- Easy-to-read 8 mm-high LED display
- Panel mounting adapter, sockets, and accessories available separately



Ordering Information

■ COUNTERS

Add the supply voltage type to the part number when you order. For example, **H7CN-XHNM-AC**.

Contact Output Types

Memory protection is not available on contact output models with DC supply voltages.

Input signal type		Contact and solid-state inputs for count and reset						
Operating mode	UP counting	DOWN counting	UP counting		DOWN counting		Reversible counting	
			Command input	Individual input				
Backup power for memory protection		Not provided			Provided		Not provided	
Output type		SPST-NO			SPDT		SPST-NO	
Max. counting speed	30 cps	H7CN-XLN	H7CN-YLN	H7CN-XLNM	H7CN-YLNM	H7CN-ALN	H7CN-BLN	
	5 kcps*	H7CN-XHN	H7CN-YHN	H7CN-XHNM	H7CN-YHNM	H7CN-AHN	H7CN-BHN	
Supply voltages	AC	100 to 240 VAC, 50/60 Hz						
	DC	12 to 48 VDC, 20% max. ripple						

*Only the solid-state input signal is available when the maximum counting speed is 5 kcps.

Solid-State Output Types

Input signal type		Contact and solid-state inputs for count and reset	
Operating mode		UP counting	DOWN counting
Backup power for memory protection		Not provided	
Output type		Open collector transistor	
Max. counting speed		5 kcps	
Part number		H7CN-XHNS	H7CN-YHNS
Supply voltages	AC	100 to 240 VAC, 50/60 Hz	
	DC	12 to 48 VDC, 20% max. ripple	

■ ACCESSORIES

Description		Part number	
Sockets	H7CN-□□N timers	Bottom surface or track mounting, top screw terminals	P2CF-08
		Back mounting, for use with Y92F-30 mounting adapter, bottom screw terminals	P3G-08
	H7CN-□□□M timers	Bottom surface or track mounting, top screw terminals	P2CF-11
		Back mounting, for use with Y92F-30 mounting adapter, bottom screw terminals	P3GA-11
Panel mounting adapter	Fits behind panel, ideal for side by side installation (Use P3G□-□□ sockets)		Y92F-30
Battery for memory backup	Use with H7CN-□□□M timers		Y92S-20
Protective cover	Hard plastic cover		Y92A-48B
	Soft plastic cover		Y92A-48D
Mounting track	DIN rail, 50 cm (1.64 ft) length		PFP-50N
	DIN rail, 1 m (3.28 ft) length		PFP-100N
	End plate		PFP-M
	Spacer		PFP-S

Specifications

■ GENERAL CAPABILITIES

Model	H7CN-□□N	H7CN-□□NS
Classification	Single preset counter	
Mounting	Panel, track or surface	
External connections	8-pin round sockets or 11-pin round sockets (-M types)	
Output modes	Sustained output until reset	
Input modes	UP (H7CN-X), DOWN (H7CN-Y), reversible with command input (H7CN-A), reversible with individual input (H7CN-B)	UP (H7CN-X), DOWN (H7CN-Y)
Reset system	Power-OFF: 0.5 sec reset time (except H7CN-M types) Reset time following power application: 0.05 sec External reset and manual: 0.02 second reset time Reset time following signal application: 0.05 sec	
Sensor power supply	Not provided	
Input signal	Count and reset	
Input method	Contact Impedance by short-circuiting contacts: 1 kΩ max. Impedance by opening contacts: 100 kΩ min.	Solid-state input Residual voltage: 0.5 V max. (1 V actual)
Control outputs	SPST-NO, 3 A, 250 VAC SPDT, 3 A, 250 VAC for H7CN-M counters	Open collector transistor, 100 mA, 30 VDC max.
Displays	7-segment LED count value display, 8 mm (0.3 in) high characters, and LED indicators for count up and reset	
Digits	4 digits	
Memory backup	H7CN-M models have a memory protection circuit that protects against momentary power failures lasting up to 10 minutes. An optional Y92S-20 lithium 3 V battery can provide up to 5 years of memory retention.	

■ RATINGS

Supply voltage	AC	100 to 240 VAC, 50/60 Hz
	DC	12 to 48 VDC (20% max. ripple)
Operating voltage range	85 to 110% of rated voltage	
Power consumption	Approx. 12 VA/2.5 W at 240 VAC, 50 Hz Approx. 2.5 W at 48 VDC	
Max. counting speeds (CP1, CP2)	30 cps with contact and solid-state inputs; 5,000 cps with solid-state inputs only	
Minimum pulse widths	16.7 ms at 30 cps (ON/OFF ratio of 1:1)	
	0.1 ms at 5 kcps (ON/OFF ratio of 1:1)	

Approved by the following standards

UL
CSA

■ CHARACTERISTICS

Ambient operating temperature		-10° to 55°C (14° to 131°F)
Storage temperature		-25° to 65°C (-13° to 149°F)
Ambient operating humidity		35 to 85% RH
Insulation resistance		100 mΩ minimum at 500 VDC
Dielectric strength		2,000 VAC, 50/60 Hz for 1 minute between current-carrying terminal and exposed metal parts, between power supply circuit and control output circuit
Vibration	Mechanical durability	10 to 55 Hz, 0.75 mm (0.03 in) double amplitude
	Malfunction durability	10 to 55Hz, 0.5 mm (0.02 in) double amplitude
Shock	Mechanical durability	Approx. 30 G
	Malfunction durability	Approx. 10 G
Service life	Mechanical	10 million operations minimum under no load at 1,800 operations/hour switching frequency
	Electrical	100,000 operations minimum under resistive load at 3 A, 250 VAC (p.f. = 1)
Weight		150 g (5.3 oz.)

Engineering Data

■ ELECTRICAL SERVICE LIFE

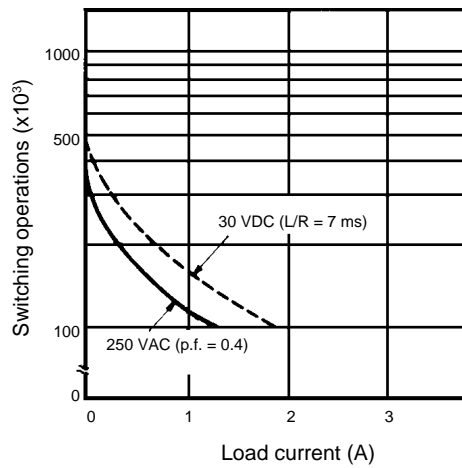
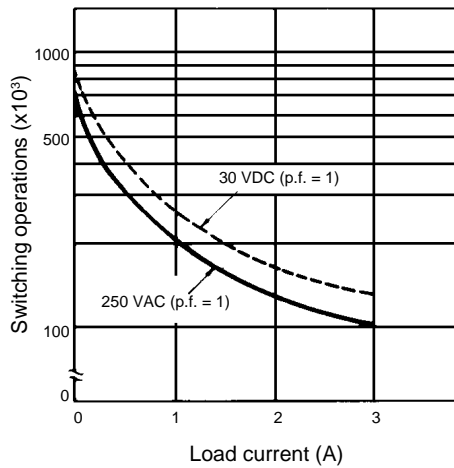

Note:
The service life graphs apply to all relay output models. They do not apply to solid-state output models H7CN-XHNS or H7CN-YHNS.

Timing Charts

INPUT OPERATION

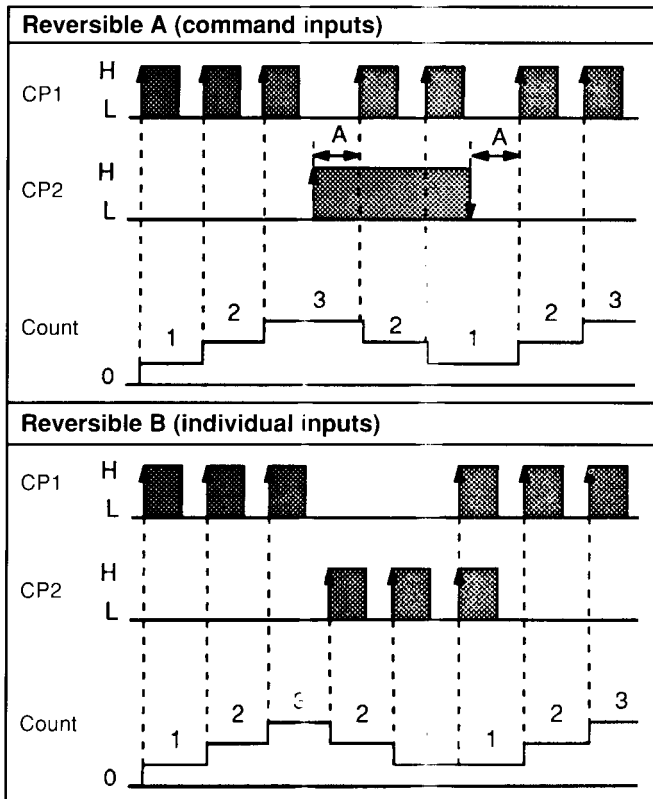
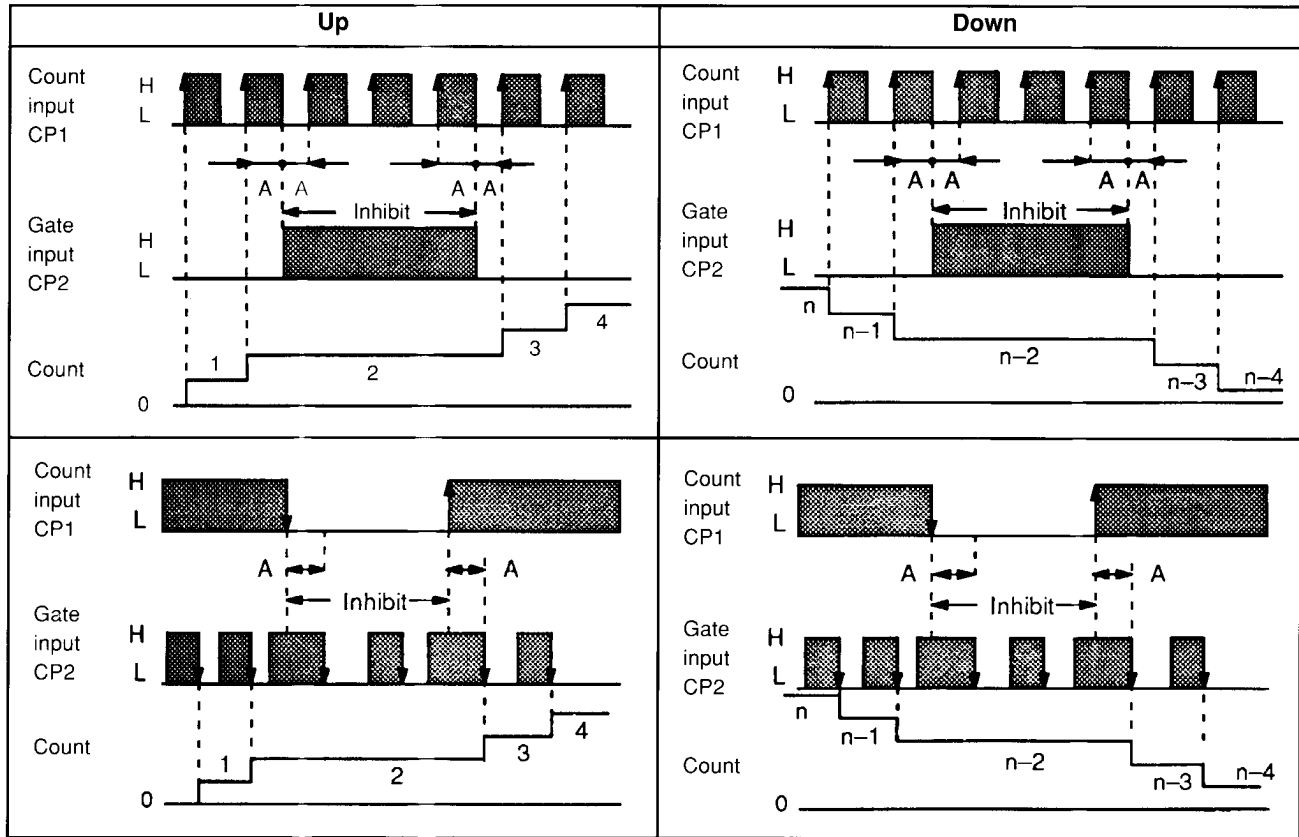

A: Minimum signal width

■ OUTPUT OPERATION

UP Counters

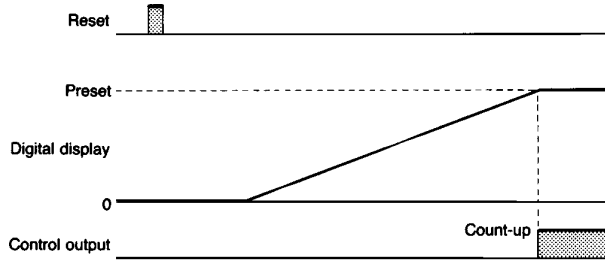

DOWN Counters

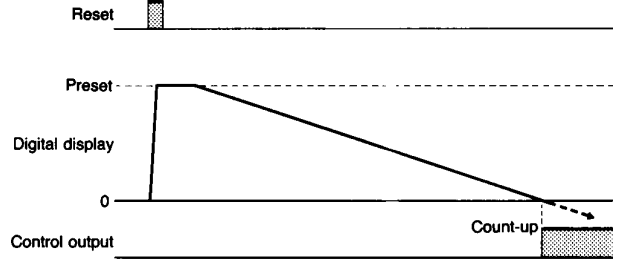

Reversible Counters

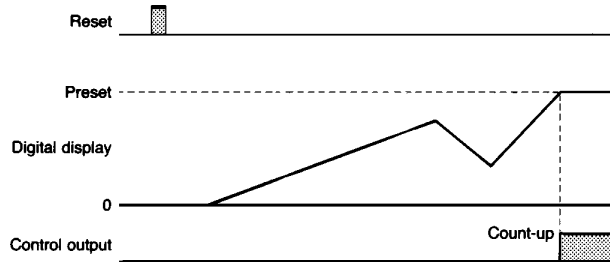

Dimensions

Unit: mm (inch)

■ COUNTERS

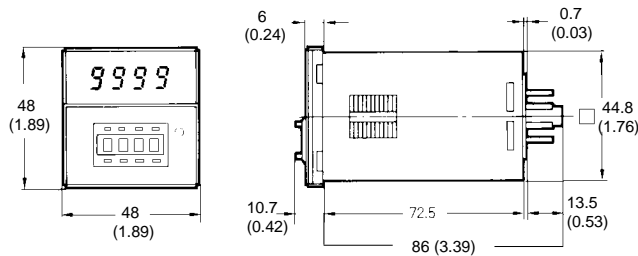
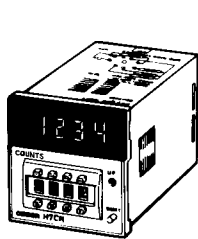

Panel cutout

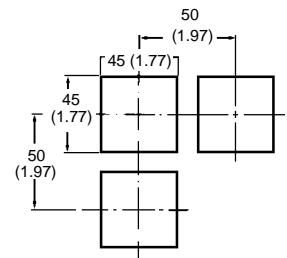

Note: Recommended panel thickness is 1 to 3.2 mm.

Panel cutout conforms to DIN 43700.

■ SOCKETS

8-Pin Sockets for H7CN-□□

P2CF-08 Bottom Surface or Track Mounting

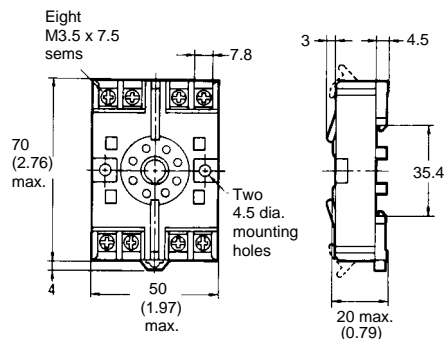
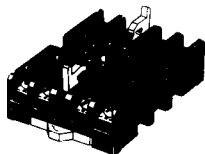

Terminal arrangement

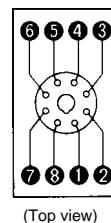

Mounting holes

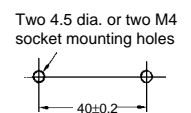

8-Pin Sockets for H7CN-□□ Continued

P3G-08 Back Mounting Socket

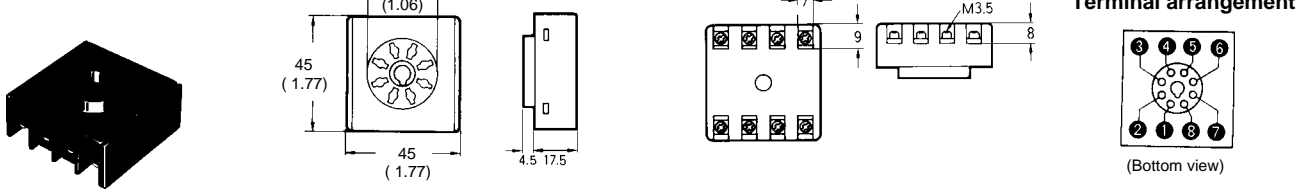

11-Pin Sockets for H7CN-□M

P2CF-11 Bottom Surface or Track Mounting Socket

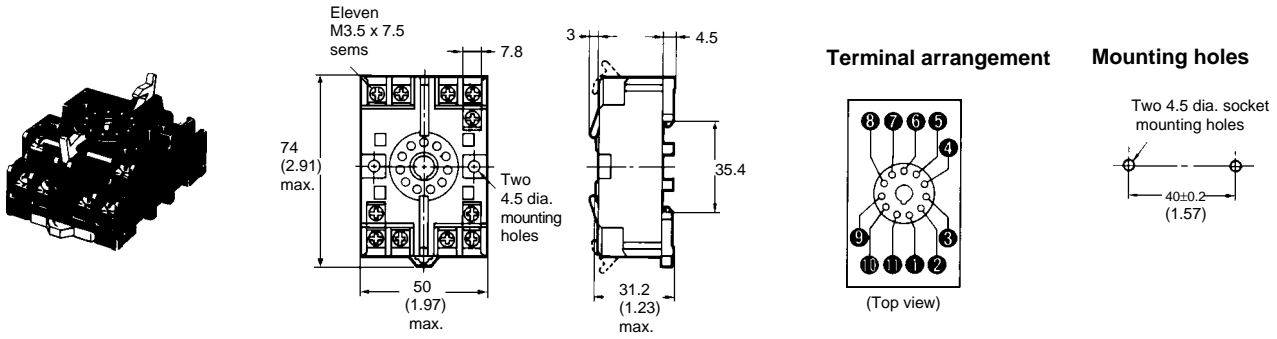

P3GA-11 Back Mounting Socket

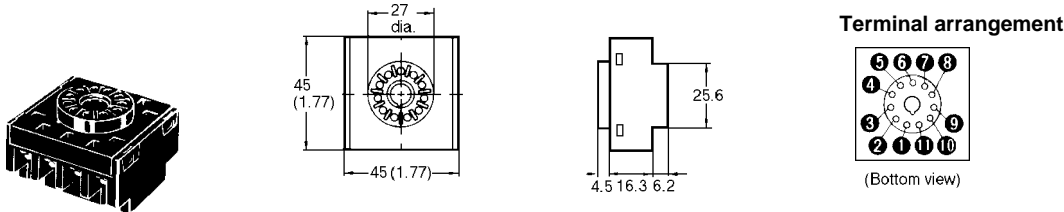

■ PANEL MOUNTING ADAPTER

Y92F-30 Mounting Adapter

Adapter installs behind the panel. It is ideal for side by side installation. Use P3GA-11 or P3G-08 sockets.

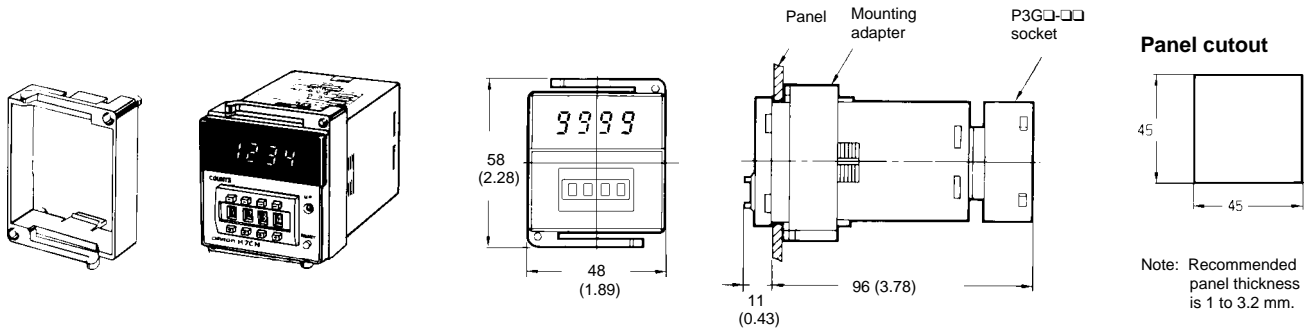

■ BATTERY FOR MEMORY BACK-UP

Y92S-20 Battery

Use this battery with H7CN-□M counters with memory protection circuit. While the counter's built-in memory protection circuit can retain values for power failures lasting up to 10 minutes, the optional battery protects memory in case of a longer power outage. We recommend using the battery as a safeguard. Memory values can be retained for up to 5 years.

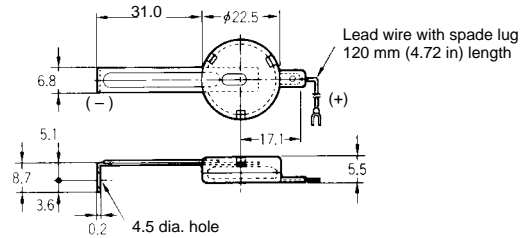
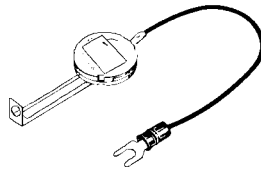

■ PROTECTIVE COVERS

Y92A-48B Hard Plastic Cover

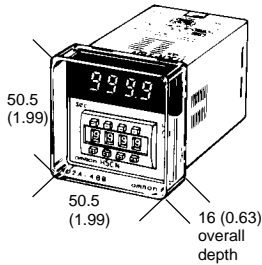

Y92A-48D Soft Plastic Cover

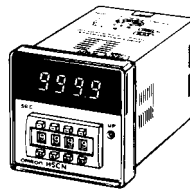

Hard plastic cover Y92A-48B and soft plastic cover Y92A-48D snap onto the front of the counter to protect against dirt and water. The Y92A-48B hard plastic cover prevents accidental resetting. Y92A-48D soft plastic cover fits snugly over the front and allows settings to be changed. These covers are intended for use in areas where unusual service conditions do not exist.

■ MOUNTING TRACK AND ACCESSORIES

PPF-100N/PPF-50N DIN Rail

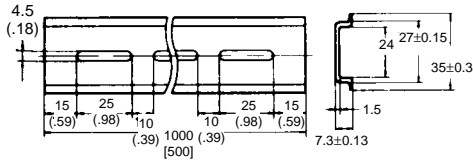

PPF-M End Plate

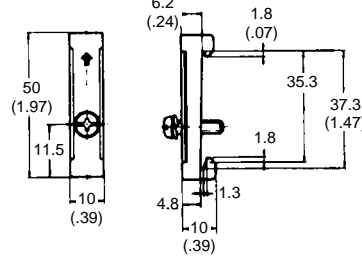

PPF-S Spacer

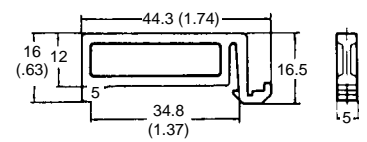

Connections

Part number	Input terminal number				Power supply terminal numbers		Output terminals			Memory	
	COM	Reset	CP1	CP2	AC (common), DC-	AC (hot), DC+	COM	NC	NO	DC-	DC+
H7CN-□□N	1	3	4	5	2	7	8	-	6	-	-
H7CN-□□□S	1	3	4	5	2	7	8	-	6	-	-
H7CN-□□□M	3	7	6	5	2	10	11	8	9	1	4

H7CN-□□N Counter

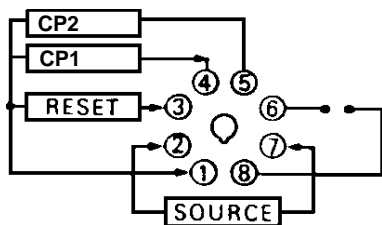

H7CN-□□□S Counter

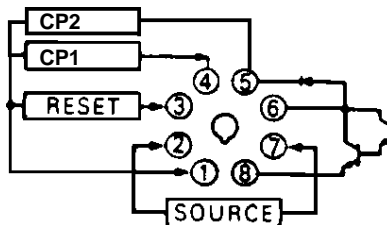

H7CN-□□□M Counter

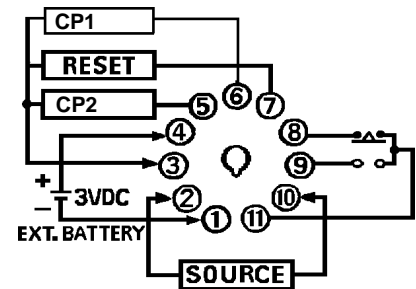

Operation

■ SETTING THE COUNT PRESET

Use the four pushwheel switches on the front panel to set the desired count. Firmly push the switches to avoid having two numbers appear in the display window. This causes the operating time to drift widely.

Do not change the setting while the counter is powered up. It may cause a momentary output to occur.

Undesirable settings

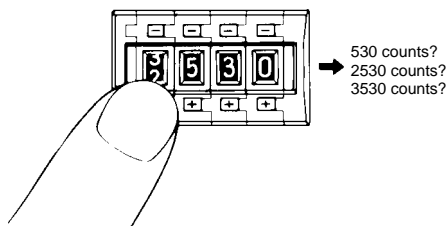

WARNING

Do not set all four digits to zero. This causes a momentary output to occur that may lead to accidental injury or damage.

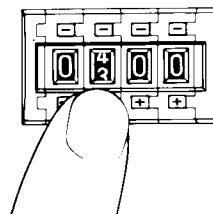

Mounting

■ PANEL MOUNTING

Using Y92F-30 Adapter

Insert the counter through the panel cutout. Push the Y92F-30 adapter from the rear of the counter as far forward toward the panel as possible. Push the P3G□-□□ socket onto the rear of the counter. Then wire the socket. Tighten the two retaining screws. To release the adapter, lift the tab at the rear of the adapter.

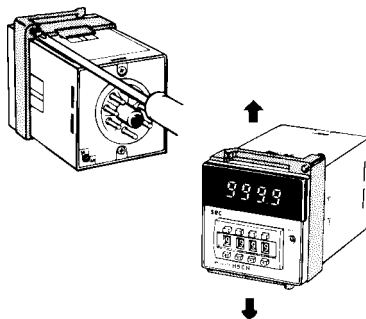

Several counters may be panel mounted close together using a Y92F-30 adapter as shown here. When mounting two or more counters in a vertical line, arrange the adapters so that their molded tabs are positioned on the right and left sides. When mounting two or more counters in a horizontal line, arrange the adapters so that their molded tabs are positioned on the top and bottom sides.

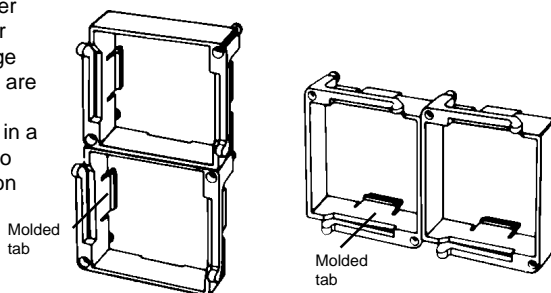

Panel cutout for side-by-side mounting of two counters

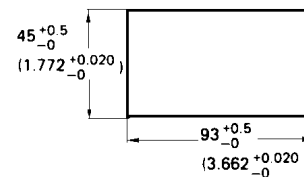

P2CF-□□ Socket

Mounting

The P2CF-□□ socket has two hooks that secure the counter to the socket. Be sure to allow at least 20 mm (0.79 in) clearance above and below the socket to gain access and to release the hooks for servicing and maintenance. Insert counter into the socket. Latch hooks. Then clip rear of the socket to the track. Push the bottom onto the track until the latch hooks securely.

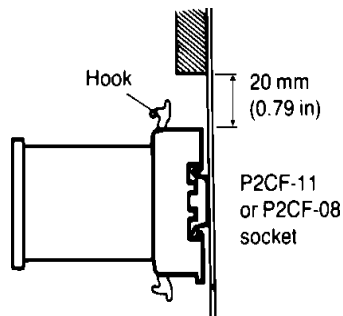

Removal

Pull the latch on the socket with a flat-blade screwdriver and remove the counter and socket as one unit.

NOTE: DIMENSIONS SHOWN ARE IN MILLIMETERS. To convert millimeters to inches, divide by 25.4.

Omron Europe B.V. EMA-ISD, tel:+31 23 5681390, fax:+31 23 5681397, <http://www.eu.omron.com/ema>